

57 **Wrenches & Torque Wrenches**

■ **Hi-Performance Combination Wrench 15° Offset**

- Chrome Vanadium Alloy Steel
- Thin profile head and ring for easy access in confined spaces
- Light weight model
- High torque performance as over 1.6 times as ANSI & DIN standard
- Satin chrome finished for maximum durability and corrosion resistance



ITEM NO. Satin	SIZE(inch)	L(mm)	Satin Chrome Finished	
ACEX0808	1/4	104	10	320
ACEX1010	5/16	124	10	320
• ACEX1111	11/32	131	10	320
ACEX1212	3/8	143	10	320
ACEX1414	7/16	151	10	240
ACEX1616	1/2	169	10	120
ACEX1818	9/16	180	10	120
ACEX2020	5/8	198	10	80
ACEX2222	11/16	206	10	80
ACEX2424	3/4	223	10	80
ACEX2626	13/16	236	10	80
ACEX2828	7/8	255	5	40
ACEX3030	15/16	274	5	40
ACEX3232	1	284	5	40
ACEX3434	1-1/16	304	5	30
ACEX3636	1-1/8	315	5	30
ACEX4040	1-1/4	355	5	20

ITEM NO. Satin	SIZE(mm)	L(mm)	Satin Chrome Finished	
AAEX5E5E	5.5	104	10	320
AAEX0606	6	104	10	320
AAEX0707	7	114	10	320
AAEX0808	8	124	10	320
AAEX0909	9	131	10	320
AAEX1010	10	143	10	320
AAEX1111	11	151	10	240
AAEX1212	12	160	10	120
AAEX1313	13	169	10	120
AAEX1414	14	180	10	120
AAEX1515	15	192	10	80
AAEX1616	16	198	10	80
AAEX1717	17	206	10	80
AAEX1818	18	214	10	80
AAEX1919	19	223	10	80
AAEX2020	20	236	10	80
AAEX2121	21	243	10	80
AAEX2222	22	255	5	40
AAEX2323	23	266	5	40
AAEX2424	24	274	5	40
AAEX2525	25	284	5	40
AAEX2626	26	294	5	30
AAEX2727	27	304	5	30
AAEX2828	28	315	5	30
AAEX2929	29	327	5	30
AAEX3030	30	340	5	30
AAEX3232	32	355	5	20

■ **POUCH BAG - BLACK** **8PCS**
15° Offset Hi-Performance Combination Wrench Set



ITEM NO. Satin	CONTENTS	Satin Chrome Finished
GPCX0801	8, 10, 12, 13, 14, 17, 19, 22	10 (SET)

■ **STORAGE RACK**
15° Offset Hi-Performance Combination Wrench Set



ITEM NO. Satin	CONTENTS	Satin Chrome Finished
GAAC0901	6, 7, 8, 10, 12, 13, 14, 17, 19	5 (SET)
GAAC1201	6, 7, 8, 9, 10, 11, 12, 13, 14, 15, 17, 19	
GAAC1401	6, 7, 8, 9, 10, 11, 12, 13, 14, 15, 17, 19, 22, 24	

HI-PERFORMANCE COMBINATION WRENCH

■ **POUCH BAG - BLACK**
15° Offset Hi-Performance Combination Wrench Set

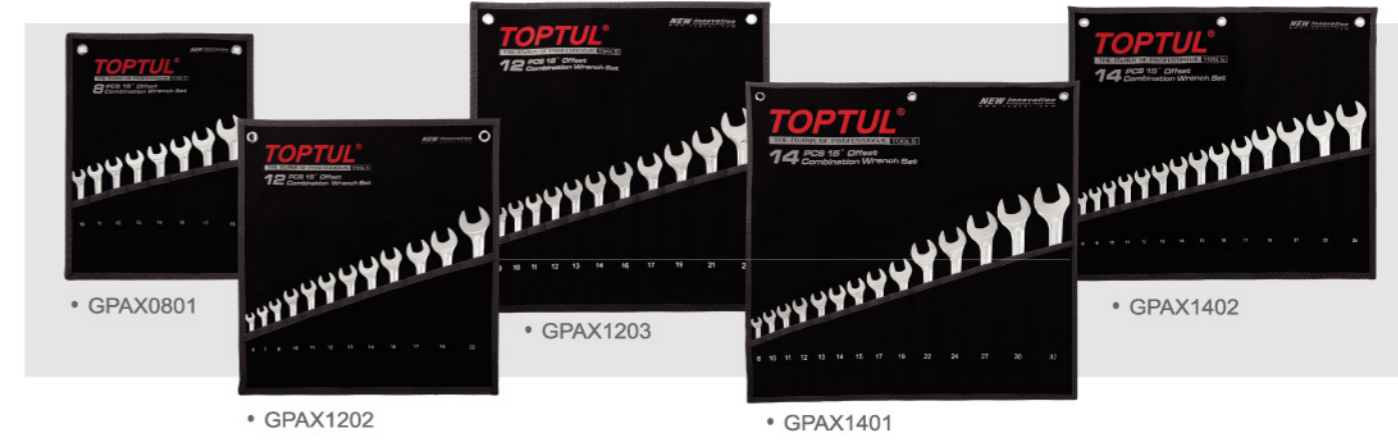

ITEM NO. Satin	CONTENTS	Satin Chrome Finished
GPAX0801	8, 10, 11, 12, 13, 14, 15, 17, 19	20
GPAX1202	6, 7, 8, 10, 11, 12, 13, 14, 15, 17, 19, 22	10
GPAX1203	8, 9, 10, 11, 12, 13, 14, 16, 17, 19, 21, 24	10
GPAX1401	8, 10, 11, 12, 13, 14, 15, 17, 19, 22, 24, 27, 30, 32	4
GPAX1402	8, 9, 10, 11, 12, 13, 14, 15, 16, 17, 19, 21, 22, 24	10

ITEM NO. Satin	CONTENTS	Satin Chrome Finished
GPAX1403	14, 6, 7, 8, 10, 12, 13, 14, 17, 19, 22, 24, 27, 30, 32	4
GPAX1601	16, 7, 8, 9, 10, 11, 12, 13, 14, 15, 17, 19, 22, 24, 27, 30, 32	4
GPBX1601	16 1/4", 5/16", 3/8", 7/16", 1/2", 9/16", 5/8", 11/16", 3/4", 13/16", 7/8", 15/16", 1", 1-1/16", 1-1/8", 1-1/4"	4
GPAX2601	26, 7, 8, 9, 10, 11, 12, 13, 14, 15, 16, 17, 18, 19, 20, 21, 22, 23, 24, 25, 26, 27, 28, 29, 30, 32	3

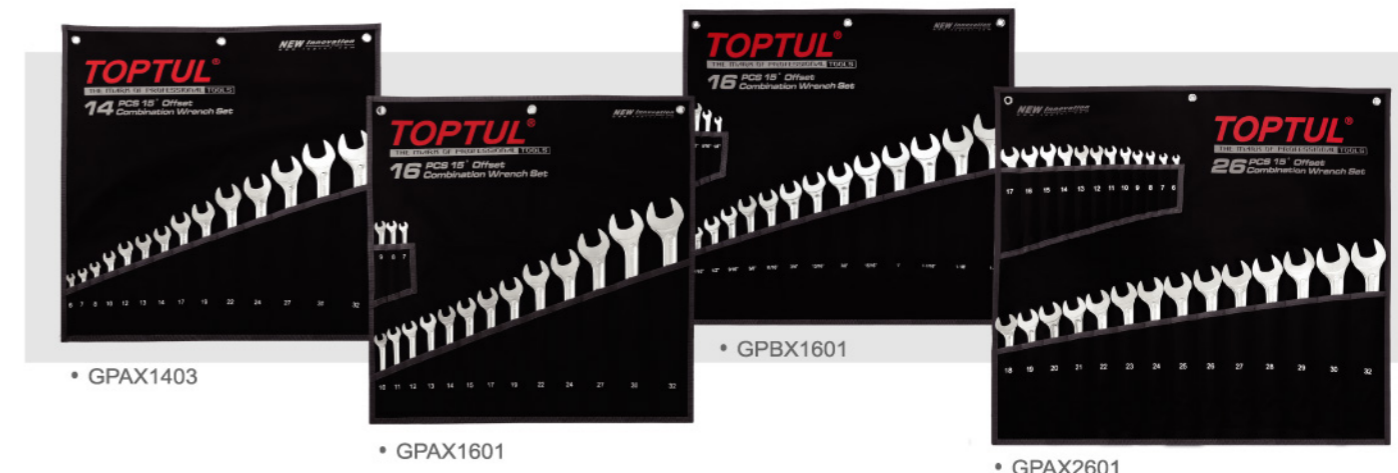

■ **METAL BOX** **16PCS**
15° Offset Hi-Performance Combination Wrench Set



ITEM NO. Satin	CONTENTS	Satin Chrome Finished
GAAD1603	16 6, 7, 8, 9, 10, 11, 12, 13, 14, 15, 16, 17, 18, 19, 22, 24	3 (SET)

METAL CASE: W445 x D188 x H50 (mm)

■ **METAL BOX** **★16PCS**
15° Offset Hi-Performance Combination Wrench Set



ITEM NO. Satin	Black	CONTENTS	Satin Chrome Finished
GBB1616		16 AAEX0606-2424 Hi-Performance Combination Wrench 15° Offset 6, 7, 8, 9, 10, 11, 12, 13, 14, 15, 16, 17, 18, 19, 22, 24	4 (SET)

METAL CASE: W417 x D176 x H53 (mm)

59 **Wrenches & Torque Wrenches**

Super-Torque Combination Wrench 15° Offset



**- AAEX SERIES -
HI-PERFORMANCE COMBINATION WRENCH**
FOR AUTOMOTIVE REPAIR & MAINTENANCE
(Thin and light weight model for quick tightening & loosening applications)

**- AAEW SERIES -
SUPER-TORQUE COMBINATION WRENCH**
FOR HEAVY DUTY INDUSTRIAL APPLICATIONS
(Strong model for toughest tightening & loosening jobs)

■ **More Efficient Open-End Design**
The improved design of 15 degree bending open-end offers a better tightening and untightening accessibility.

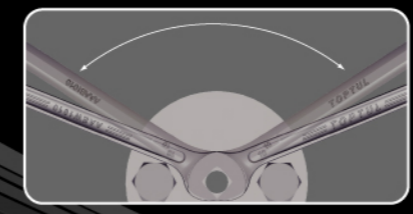

■ **Better Ring Head Accessibility**
Specially designed ring head provides better clearance for reaching recessed spaced nuts.



■ **Extra Comfort & Effective Grip**
Larger side handle and recess frame handle design maximize the contact comfort with the hand.



Super-Torque Combination Wrench 15° Offset

- Chrome Vanadium Alloy Steel
- Robust construction design to work under extreme conditions
- High torque performance as over 2 times as ANSI & DIN standard
- Satin chrome finished for maximum durability and corrosion resistance



ITEM NO. Satin	SIZE(mm)	L(mm)	Satin Chrome Finished	
AAEW0606	6	104	10	320
AAEW0707	7	114	10	320
AAEW0808	8	124	10	320
AAEW0909	9	131	10	320
AAEW1010	10	143	10	320
AAEW1111	11	151	10	240
AAEW1212	12	160	10	120
AAEW1313	13	169	10	120
AAEW1414	14	180	10	120
AAEW1515	15	192	10	80
AAEW1616	16	198	10	80
AAEW1717	17	206	10	80
AAEW1818	18	214	10	80
AAEW1919	19	223	10	80
AAEW2020	20	236	10	80
AAEW2121	21	243	10	80
AAEW2222	22	255	5	40
AAEW2323	23	266	5	40
AAEW2424	24	274	5	40
AAEW2525	25	284	5	40
AAEW2626	26	294	5	30
AAEW2727	27	304	5	30
AAEW2828	28	315	5	30
AAEW2929	29	327	5	30
AAEW3030	30	340	5	30
AAEW3232	32	355	5	20

ITEM NO. Satin	SIZE(inch)	L(mm)	Satin Chrome Finished	
ACEW0808	1/4	104	10	320
ACEW1010	5/16	124	10	320
• ACEW1111	11/32	131	10	320
ACEW1212	3/8	143	10	320
ACEW1414	7/16	151	10	240
ACEW1616	1/2	169	10	120
ACEW1818	9/16	180	10	120
ACEW2020	5/8	198	10	80
ACEW2222	11/16	206	10	80
ACEW2424	3/4	223	10	80
ACEW2626	13/16	236	10	80
ACEW2828	7/8	255	5	40
ACEW3030	15/16	274	5	40
ACEW3232	1	284	5	40
ACEW3434	1-1/16	304	5	30
ACEW3636	1-1/8	315	5	30
ACEW4040	1-1/4	355	5	20



POUCH BAG - BLACK
15° Offset Super-Torque Combination Wrench Set

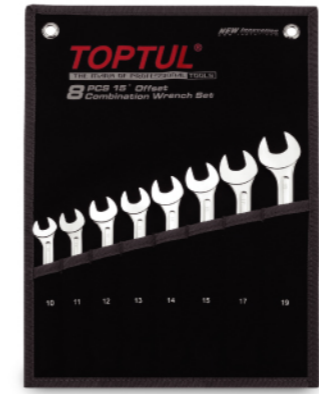

ITEM NO. Satin	CONTENTS	Satin Chrome Finished (SET)
GPAW0801	10, 11, 12, 13, 14, 15, 17, 19	20
GPAW1202	6, 7, 8, 10, 11, 12, 13, 14, 15, 17, 19, 22	10
GPAW1401	8, 10, 11, 12, 13, 14, 15, 17, 19, 22, 24, 27, 30, 32	4
GPAW1402	8, 9, 10, 11, 12, 13, 14, 15, 16, 17, 19, 21, 22, 24	10
GPAW1601	7, 8, 9, 10, 11, 12, 13, 14, 15, 17, 19, 22, 24, 27, 30, 32	4
GPBW1601	1/4", 5/16", 3/8", 7/16", 1/2", 9/16", 5/8", 11/16", 3/4", 13/16", 7/8", 15/16", 1", 1-1/16", 1-1/8", 1-1/4"	4
GPAW2601	6, 7, 8, 9, 10, 11, 12, 13, 14, 15, 16, 17, 18, 19, 20, 21, 22, 23, 24, 25, 26, 27, 28, 29, 30, 32	3

METAL BOX
15° Offset Super-Torque Combination Wrench Set **★16PCS**



ITEM NO. Black	CONTENTS	Satin Chrome Finished (SET)
GBB1601	16 AAEW0606-2424 Super-Torque Combination Wrench 15° Offset 6, 7, 8, 9, 10, 11, 12, 13, 14, 15, 16, 17, 18, 19, 22, 24	4 (SET)
METAL CASE: W417 x D176 x H53 (mm)		



**SUPER-TORQUE
COMBINATION WRENCH**

TOPTUL
YOUR BEST WORKING PARTNERS

61 Wrenches & Torque Wrenches



**- AAEQ SERIES -
SUPER-TORQUE DYNAMIC COMBINATION WRENCH**

**TOPTUL Dynamic / Ratchet-Effect
Combination Wrench**

This special designed open end wrench allows the user to tighten or loosen the fastener without removing the wrench from the fastener to change position. The open end grabs the fastener when torque pressure is applied making it difficult to slip. Perfect for confined space applications.

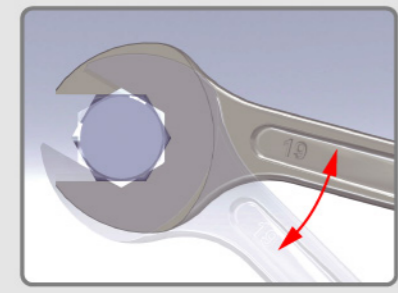
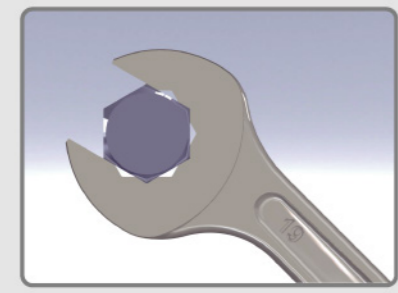
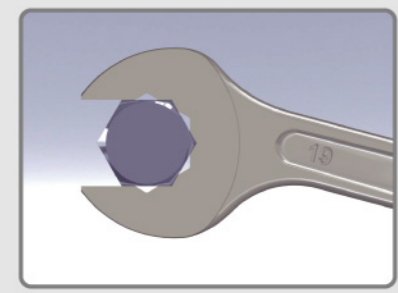

Super-Torque Dynamic Combination Wrench 15° Offset

- Chrome Vanadium Alloy Steel
- Robust construction design to work under extreme conditions
- High torque performance as over 1.6 times as ANSI & DIN standard
- Satin chrome finished for maximum durability and corrosion resistance



ITEM NO. Satin	SIZE(mm)	L(mm)		
AAEQ0808	8	124	10	320
AAEQ0909	9	131	10	320
AAEQ1010	10	143	10	320
AAEQ1111	11	151	10	240
AAEQ1212	12	160	10	120
AAEQ1313	13	169	10	120
AAEQ1414	14	180	10	120
AAEQ1515	15	192	10	80
AAEQ1616	16	198	10	80
AAEQ1717	17	206	10	80
AAEQ1818	18	214	10	80
AAEQ1919	19	223	10	80
AAEQ2020	20	236	10	80
AAEQ2121	21	243	10	80
AAEQ2222	22	255	5	40
AAEQ2323	23	266	5	40
AAEQ2424	24	274	5	40

POUCH BAG - BLACK 14PCS
15° Offset Super-Torque Dynamic Combination Wrench Set



ITEM NO. Satin	CONTENTS		
GPAQ1402	14 8, 9, 10, 11, 12, 13, 14, 15, 16, 17, 19, 21, 22, 24	10 (SET)	

- Heavy Duty Wrenches Series -



Slogging Ring Wrench

- Chrome-Molybdenum Alloy Steel
- Manganese Phosphate Finished



ITEM NO. Black Phosphate	SIZE(mm)	L(mm)		
AAAR2222	22	162	8	96
AAAR2323	23	162	8	96
AAAR2424	24	162	8	96
AAAR2525	25	162	8	96
AAAR2626	26	179	5	60
AAAR2727	27	179	5	60
AAAR2828	28	179	5	60
AAAR2929	29	189	5	60
AAAR3030	30	189	5	60
AAAR3232	32	189	5	60
AAAR3333	33	189	5	60
AAAR3434	34	204	4	32
AAAR3535	35	204	4	32
AAAR3636	36	204	4	32
AAAR3838	38	204	4	32
AAAR4040	40	229	3	24
AAAR4141	41	229	3	24
AAAR4242	42	229	3	24
AAAR4343	43	229	3	24
AAAR4444	44	240	2	16
AAAR4545	45	240	2	16
AAAR4646	46	240	2	16
AAAR4747	47	240	2	16
AAAR4848	48	253	2	16
AAAR5050	50	253	2	16
AAAR5252	52	253	2	16
AAAR5555	55	271	2	12
AAAR6060	60	281	2	12
AAAR6565	65	281	2	12
AAAR7070	70	335	1	6
AAAR7575	75	335	1	6
AAAR8080	80	365	1	4
AAAR8585	85	365	1	4
AAAR9090	90	400	1	2
AAAR9595	95	400	1	2
AAARA0A0	100	435	1	2
AAARA5A5	105	435	1	2

Single Open End Wrench

- Chrome-Molybdenum Alloy Steel
- Manganese Phosphate Finished



ITEM NO. Black Phosphate	SIZE(mm)	L(mm)		
AAAT1616	16	161	10	160
AAAT1717	17	161	10	160
AAAT1818	18	161	10	160
AAAT1919	19	177	10	160
AAAT2020	20	177	10	160
AAAT2121	21	177	10	160
AAAT2222	22	197	6	96
AAAT2323	23	197	6	96
AAAT2424	24	197	6	96
AAAT2525	25	216	6	48
AAAT2626	26	216	6	48
AAAT2727	27	216	6	48
AAAT2828	28	243	6	48
AAAT2929	29	243	6	48
AAAT3030	30	243	6	48
AAAT3232	32	273	5	40
AAAT3333	33	273	5	40
AAAT3434	34	273	5	40
AAAT3535	35	299	5	30
AAAT3636	36	299	5	30
AAAT3838	38	299	5	30
AAAT4141	41	337	4	24
AAAT4242	42	337	4	24
AAAT4343	43	337	4	24
AAAT4444	44	374	3	18
AAAT4545	45	374	3	18
AAAT4646	46	374	3	18
AAAT4848	48	417	3	12
AAAT5050	50	417	3	12
AAAT5555	55	496	2	8
AAAT5858	58	496	2	8
AAAT6060	60	496	2	8

Single Ring Wrench 45° Offset

- Chrome-Molybdenum Alloy Steel
- Manganese Phosphate Finished



ITEM NO. Black Phosphate	SIZE(mm)	L(mm)		
AAAS1717	17	324	5	30
AAAS1919	19	324	5	30
AAAS2121	21	368	5	20
AAAS2222	22	368	5	20
AAAS2323	23	368	5	20
AAAS2424	24	382	5	20
AAAS2626	26	382	5	20
AAAS2727	27	394	5	20
AAAS2929	29	394	5	20
AAAS3030	30	410	5	20
AAAS3232	32	410	5	20
AAAS3434	34	465	4	16
AAAS3535	35	465	4	16
AAAS3636	36	465	4	16
AAAS3838	38	490	3	12
AAAS4141	41	490	3	12
AAAS4343	43	519	3	12
AAAS4444	44	519	3	12
AAAS4646	46	519	3	12
AAAS4848	48	594	2	4
AAAS5050	50	594	2	4
AAAS5555	55	594	2	4
AAAS5858	58	616	1	2
AAAS6060	60	616	1	2
AAAS6565	65	616	1	2

63 Wrenches & Torque Wrenches

Heavy Duty Wrenches Series



Slugging Ring Wrench 45° Offset

- Chrome Vanadium Steel Material
- Manganese Phosphate Finished



Single Ring Wrench 45° Offset

- Chrome Vanadium Steel Material
- Manganese Phosphate Finished
- For use in combination with ALEA series handles



ITEM NO. Black Phosphate	SIZE(mm)	L(mm)	📦	📦
AAAU2424	24	250	3	12
AAAU2727	27	250	3	12
AAAU3030	30	270	3	12
AAAU3232	32	270	3	12
AAAU3636	36	300	2	8
AAAU3838	38	300	2	8
AAAU4141	41	317	2	8
AAAU4343	43	317	2	8
AAAU4646	46	360	2	4
AAAU5050	50	360	2	4
AAAU5555	55	360	2	4
AAAU6060	60	360	2	4
AAAU6565	65	380	2	4
AAAU7070	70	380	2	4
AAAU7575	75	415	1	2
AAAU8080	80	420	1	2
AAAU8585	85	450	1	2
AAAU9090	90	453	1	2
AAAU9595	95	500	1	2
AAAU0A0	100	505	1	2
AAUA5A5	105	520	1	2

ITEM NO. Black Phosphate	SIZE(mm)	L(mm)	📦	📦
AAAV2424	24	190	5	20
AAAV2727	27	190	5	20
AAAV3030	30	195	5	20
AAAV3232	32	195	5	20
AAAV3636	36	213	2	8
AAAV3838	38	213	2	8
AAAV4141	41	251	2	8
AAAV4343	43	251	2	8
AAAV4646	46	274	2	8
AAAV5050	50	274	2	8
AAAV5555	55	287	2	8
AAAV6060	60	300	2	8
AAAV6565	65	309	2	8
AAAV7070	70	309	2	8
AAAV7575	75	340	2	4
AAAV8080	80	340	2	4
AAAV8585	85	360	2	4
AAAV9090	90	360	2	4
AAAV9595	95	378	1	2
AAAVA0A0	100	378	1	2
AAAVA5A5	105	380	1	2

Drive Handle

- Chrome Vanadium Steel Material
- For use in combination with AAV series wrenches



ITEM NO. Satin	CAPACITY(mm)	L(mm)	📦	📦
ALEA2430	24-30	350	4	16
ALEA3255	32-55	580	4	16
ALEA60A5	60-105	850	4	8



Extra Long Combination Wrench 15° Offset

- Chrome Vanadium Steel Material
- Extra long shank for reaching fasteners easily in deep space
- Professional quality for maximum durability and corrosion resistance



ITEM NO. Satin	SIZE(mm)	L(mm)	📦	📦
AAEL1010	10	187	10	120
AAEL1111	11	205	10	80
AAEL1212	12	223	10	80
AAEL1313	13	241	10	80
AAEL1414	14	259	10	80
AAEL1515	15	277	10	80
AAEL1616	16	295	10	80
AAEL1717	17	312	10	60
AAEL1818	18	331	10	60
AAEL1919	19	347	10	60

Long Combination Wrench 15° Offset

- Chrome Vanadium Steel Material
- Long shank for extra torque with less operational strength requirement
- Professional quality for maximum durability and corrosion resistance



ITEM NO. Satin	SIZE(mm)	L(mm)	📦	📦
AAEA0606	6	129	10	320
AAEA0707	7	136	10	320
AAEA0808	8	145	10	240
AAEA0909	9	157	10	240
AAEA1010	10	170	10	240
AAEA1111	11	182	10	120
AAEA1212	12	193	10	120
AAEA1313	13	205	10	80
AAEA1515	15	230	10	80
AAEA1616	16	241	10	80
AAEA1717	17	254	10	80
AAEA1818	18	266	10	80
AAEA1919	19	278	10	80
AAEA2020	20	278	10	80
AAEA2121	21	301	10	60
AAEA2222	22	316	5	30
AAEA2323	23	335	5	30
AAEA2424	24	335	5	30
AAEA2525	25	369	5	30
AAEA2626	26	369	5	30
AAEA2727	27	385	5	30
AAEA2828	28	385	5	30
AAEA2929	29	402	5	30
AAEA3030	30	402	5	30
AAEA3232	32	429	5	10

TRAY 15° Offset Extra Long Combination Wrench Set

10PCS



ITEM NO. Satin	CONTENTS	📦
GAAF1008	10, 11, 12, 13, 14, 15, 16, 17, 18, 19	10 (SET)

STORAGE RACK 15° Offset Extra Long Combination Wrench Set

7PCS



ITEM NO. Satin	CONTENTS	📦
GAAM0706	10, 11, 12, 13, 14, 17, 19	2 (SET)

Long Combination Wrench 15° Offset

- Chrome Vanadium Steel Material
- Long shank for extra torque with less operational strength requirement
- Professional quality for maximum durability and corrosion resistance



ITEM NO. Mirror	SIZE(inch)	L(mm)	📦	📦
ACAA0808	1/4	129	10	320
ACAA1010	5/16	145	10	240
ACAA1111	11/32	157	10	240
ACAA1212	3/8	170	10	240
ACAA1414	7/16	182	10	120
ACAA1616	1/2	205	10	80
ACAA1818	9/16	218	10	80
ACAA2020	5/8	241	10	80
ACAA2222	11/16	254	10	80
ACAA2424	3/4	278	10	80
ACAA2626	13/16	301	10	60
ACAA2828	7/8	316	5	30
ACAA3030	15/16	335	5	30
ACAA3232	1	369	5	30
ACAA3434	1-1/16	385	5	30
ACAA3636	1-1/8	402	5	30
ACAA4040	1-1/4	429	5	10

65 **Wrenches & Torque Wrenches**

Pro-Line Combination Wrench 15° Offset



**-AAB SERIES-
STANDARD COMBINATION WRENCH**
FOR GENERAL INDUSTRIAL APPLICATIONS
(Professional model for quick tightening & loosening application)

**-AABW SERIES-
PRO-LINE COMBINATION WRENCH**
FOR AUTOMOTIVE REPAIR & MAINTENANCE
(Strong and perfect weight ratio model for best performance and maximize jobs)

Pro-Line Combination Wrench 15° Offset

- Chrome Vanadium Alloy Steel
- Thin profile head and ring for easy access in confined spaces
- Light weight model
- High torque performance as over 1.6 times as ANSI & DIN standard
- Satin chrome finished for maximum durability and corrosion resistance

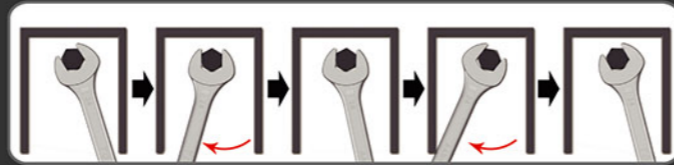

More Efficient Open-End Design
The design of the bending open-end aligns with center line of the handle in angle 15 degrees. Rotate bending open-end oppositely to increase work area in confined space for tightening and loosening applications.

Extra Comfort & Effective Grip
Larger side handle to maximize the contact comfort and enhance grip power with the hand.

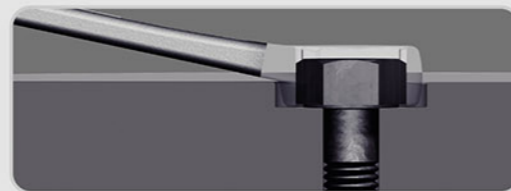

Better Ring Head Accessibility
Specially designed ring head provides better clearance for reaching recessed spaced nuts.



Protuberant Character Design
The visible and notable stamping characters provides easy reading before use.

ITEM NO. Satin	SIZE(mm)	L(mm)	Satin Chrome Finished	
AABW0606	6	104	10	320
AABW0707	7	114	10	320
AABW0808	8	124	10	320
AABW0909	9	131	10	320
AABW1010	10	143	10	320
AABW1111	11	151	10	240
AABW1212	12	160	10	120
AABW1313	13	169	10	120
AABW1414	14	180	10	120
AABW1515	15	192	10	80
AABW1616	16	198	10	80
AABW1717	17	206	10	80
AABW1818	18	214	10	80
AABW1919	19	223	10	80
AABW2020	20	236	10	80
AABW2121	21	243	10	80
AABW2222	22	255	5	40
AABW2323	23	266	5	40
AABW2424	24	274	5	40
AABW2525	25	284	5	40
AABW2626	26	294	5	30
AABW2727	27	304	5	30
AABW2828	28	315	5	30
AABW2929	29	327	5	30
AABW3030	30	340	5	30
AABW3232	32	355	5	20

PRO-LINE COMBINATION WRENCH

POUCH BAG - BLACK
15° Offset Pro-Line Combination Wrench Set



• GPCW0801

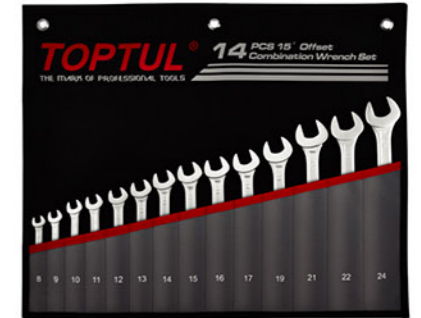

• GPCW1401

ITEM NO. Satin	CONTENTS	Satin Chrome Finished	(SET)
GPCW0801	8, 10, 12, 13, 14, 17, 19, 22	10	

ITEM NO. Satin	CONTENTS	Satin Chrome Finished	(SET)
GPCW1401	14, 8, 9, 10, 11, 12, 13, 14, 15, 16, 17, 19, 21, 22, 24	10	

POUCH BAG - GREEN
15° Offset Pro-Line Combination Wrench Set



• GRAW0801

• GRAW1001

• GRAW1601

ITEM NO. Satin	CONTENTS	Satin Chrome Finished	(SET)
GRAW0801	8, 10, 12, 13, 14, 17, 19, 22	10	
GRAW1001	10, 8, 10, 11, 12, 13, 14, 17, 19, 22, 24	10	

ITEM NO. Satin	CONTENTS	Satin Chrome Finished	(SET)
GRAW1401	14, 8, 9, 10, 11, 12, 13, 14, 15, 16, 17, 19, 21, 22, 24	10	
GRAW1601	16, 6, 7, 8, 9, 10, 11, 12, 13, 14, 15, 16, 17, 18, 19, 22, 24	6	

METAL BOX
15° Offset Pro-Line Combination Wrench Set



ITEM NO. Satin	CONTENTS	Satin Chrome Finished	(SET)
GAAD1604	16, 6, 7, 8, 9, 10, 11, 12, 13, 14, 15, 16, 17, 18, 19, 22, 24	3	

METAL CASE: W445 x D188 x H50 (mm)

16PCS

67 **Wrenches & Torque Wrenches**

- Standard Combination Wrench 15° Offset
 - Chrome Vanadium Steel Material
 - High torque performance as over 1.6 times as ANSI & DIN standard
 - Professional quality for maximum durability and corrosion resistance

- Standard Combination Wrench 15° Offset
 - Chrome Vanadium Steel Material
 - High torque performance as over 1.6 times as ANSI & DIN standard
 - Professional quality for maximum durability and corrosion resistance

- Standard Combination Wrench 15° Offset
 - Chrome Vanadium Steel Material
 - High torque performance as over 1.6 times as ANSI & DIN standard
 - Professional quality for maximum durability and corrosion resistance

- STORAGE RACK 11PCS
 - 15° Offset Standard Combination Wrench Set



ITEM NO.	CONTENTS	5 (SET)
GAAC1103	8, 10, 11, 12, 13, 14, 15, 16, 17, 18, 19	

- COLOR BOX 12PCS
 - 15° Offset Standard Combination Wrench Set



ITEM NO.	CONTENTS	10 (SET)
GAEE1210	6, 7, 8, 9, 10, 11, 12, 13, 14, 15, 17, 19	
GAEE1211		

- METAL BOX 16PCS
 - 15° Offset Standard Combination Wrench Set



ITEM NO.	CONTENTS	3 (SET)
GAAD1602	6, 7, 8, 9, 10, 11, 12, 13, 14, 15, 16, 17, 18, 19, 22, 24	

METAL CASE: W445 x D188 x H50 (mm)



ITEM NO.	SIZE(mm)	L(mm)	Mirror Polished	
			Hand	Box
AAAB0606	6	109	10	320
AAAB0707	7	119	10	320
AAAB0808	8	129	10	320
AAAB0909	9	139	10	320
AAAB1010	10	149	10	320
AAAB1111	11	159	10	240
AAAB1212	12	169	10	120
AAAB1313	13	179	10	120
AAAB1414	14	189	10	120
AAAB1515	15	199	10	80
AAAB1616	16	209	10	80
AAAB1717	17	219	10	80
AAAB1818	18	229	10	80
AAAB1919	19	239	10	80
AAAB2020	20	249	10	80
AAAB2121	21	259	10	80
AAAB2222	22	269	5	40
AAAB2323	23	279	5	40
AAAB2424	24	289	5	40
AAAB2525	25	299	5	40
AAAB2626	26	309	5	30
AAAB2727	27	319	5	30
AAAB2828	28	329	5	30
AAAB2929	29	339	5	30
AAAB3030	30	349	5	30
AAAB3232	32	369	5	20

ITEM NO.	SIZE(mm)	L(mm)	Satin Chrome Finished	
			Hand	Box
AAEB0606	6	109	10	320
AAEB0707	7	119	10	320
AAEB0808	8	129	10	320
AAEB0909	9	139	10	320
AAEB1010	10	149	10	320
AAEB1111	11	159	10	240
AAEB1212	12	169	10	120
AAEB1313	13	179	10	120
AAEB1414	14	189	10	120
AAEB1515	15	199	10	80
AAEB1616	16	209	10	80
AAEB1717	17	219	10	80
AAEB1818	18	229	10	80
AAEB1919	19	239	10	80
AAEB2020	20	249	10	80
AAEB2121	21	259	10	80
AAEB2222	22	269	5	40
AAEB2323	23	279	5	40
AAEB2424	24	289	5	40
AAEB2525	25	299	5	40
AAEB2626	26	309	5	30
AAEB2727	27	319	5	30
AAEB2828	28	329	5	30
AAEB2929	29	339	5	30
AAEB3030	30	349	5	30
AAEB3232	32	369	5	20
AAEB3333	33	409	5	20
AAEB3434	34	409	5	20
AAEB3535	35	409	5	20
AAEB3636	36	439	5	10
AAEB3838	38	439	5	10
AAEB4040	40	479	2	8
AAEB4141	41	479	2	8
AAEB4242	42	479	2	8
AAEB4343	43	479	2	8

ITEM NO.	SIZE(inch)	L(mm)	Mirror Polished	
			Hand	Box
ACAB0808	1/4	109	10	320
ACAB1010	5/16	129	10	320
ACAB1111	11/32	139	10	320
ACAB1212	3/8	149	10	320
ACAB1414	7/16	159	10	240
ACAB1616	1/2	179	10	120
ACAB1818	9/16	189	10	120
ACAB2020	5/8	209	10	80
ACAB2222	11/16	219	10	80
ACAB2424	3/4	239	10	80
ACAB2626	13/16	259	10	80
ACAB2828	7/8	269	5	40
ACAB3030	15/16	289	5	40
ACAB3232	1	299	5	40
ACAB3434	1-1/16	319	5	30
ACAB3636	1-1/8	339	5	30
ACAB4040	1-1/4	369	5	20

- Standard Combination Wrench 15° Offset
 - Chrome Vanadium Steel Material
 - High torque performance as over 1.6 times as ANSI & DIN standard
 - Professional quality for maximum durability and corrosion resistance



ITEM NO.	SIZE(inch)	L(mm)	Satin Chrome Finished	
			Hand	Box
ACEB4242	1-5/16	409	5	20
ACEB4444	1-3/8	409	5	20
ACEB4646	1-7/16	439	5	10
ACEB4848	1-1/2	439	5	10
ACEB5252	1-5/8	479	2	8
ACEB5454	1-11/16	479	2	8
ACEB5656	1-3/4	549	2	4
ACEB5858	1-13/16	549	2	4
ACEB6060	1-7/8	549	2	4
ACEB6464	2	549	2	4
ACEB6868	2-1/8	609	2	4
ACEB7070	2-3/16	609	2	4
ACEB7272	2-1/4	609	2	4
ACEB7676	2-3/8	699	1	2
ACEB8080	2-1/2	699	1	2

- Standard Combination Wrench 15° Offset (Jumbo)
 - Chrome Vanadium Steel Material
 - High torque performance as over 1.6 times as ANSI & DIN standard
 - Professional quality for maximum durability and corrosion resistance



ITEM NO.	SIZE(mm)	L(mm)	Satin Chrome Finished	
			Hand	Box
AAEB4545	45	549	2	4
AAEB4646	46	549	2	4
AAEB4848	48	549	2	4
AAEB5050	50	549	2	4
AAEB5555	55	609	2	4
AAEB6060	60	699	1	2
AAEB6565	65	699	1	2
AAEB7070	70	680	1	2
AAEB7575	75	720	1	2
AAEB8080	80	720	1	2



TOPTUL
Standard Combination Wrench
15° Offset

69 **Wrenches & Torque Wrenches**

POUCH BAG - BLACK
15° Offset Standard Combination Wrench Set

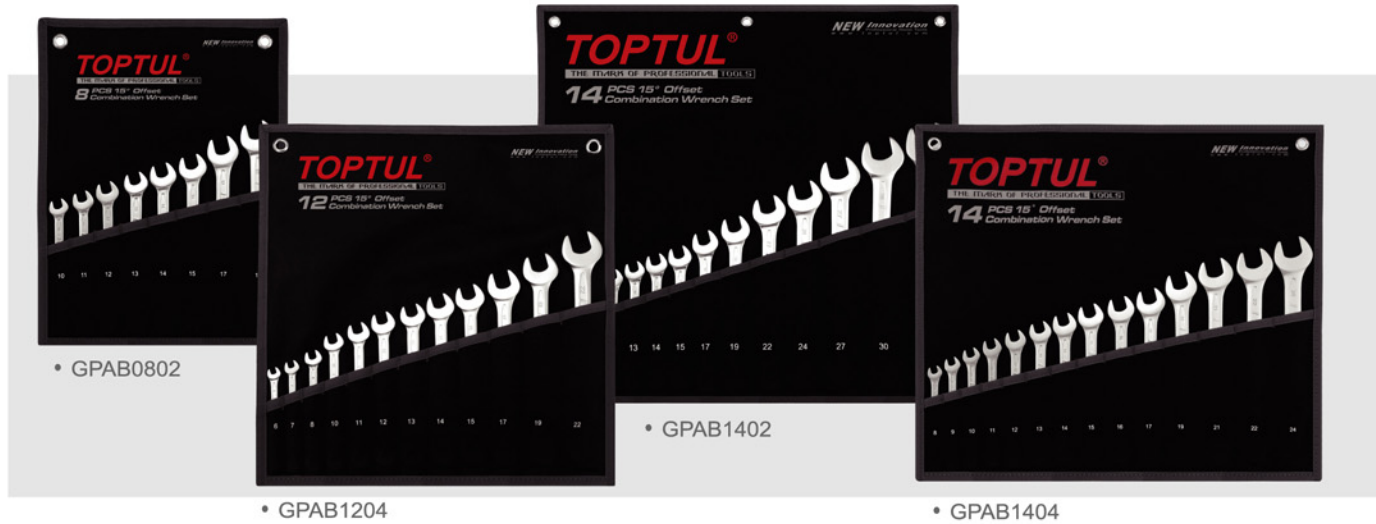

ITEM NO.	CONTENTS	Satin Chrome Finished	ITEM NO.	CONTENTS	Satin Chrome Finished
Satin		(SET)	Satin		(SET)
GPAB0802	10, 11, 12, 13, 14, 15, 17, 19	20	GPAB1406	14 6, 7, 8, 10, 12, 13, 14, 17, 19, 22, 24, 27, 30, 32	4
GPAB1204	12 6, 7, 8, 10, 11, 12, 13, 14, 15, 17, 19, 22	10	GPAB1602	16 7, 8, 9, 10, 11, 12, 13, 14, 15, 17, 19, 22, 24, 27, 30, 32	4
GPAB1402	14 8, 10, 11, 12, 13, 14, 15, 17, 19, 22, 24, 27, 30, 32	4	GPAB2602	26 6, 7, 8, 9, 10, 11, 12, 13, 14, 15, 16, 17, 18, 19, 20, 21, 22, 23, 24, 25, 26, 27, 28, 29, 30, 32	3
GPAB1404	14 8, 9, 10, 11, 12, 13, 14, 15, 16, 17, 19, 21, 22, 24	10			

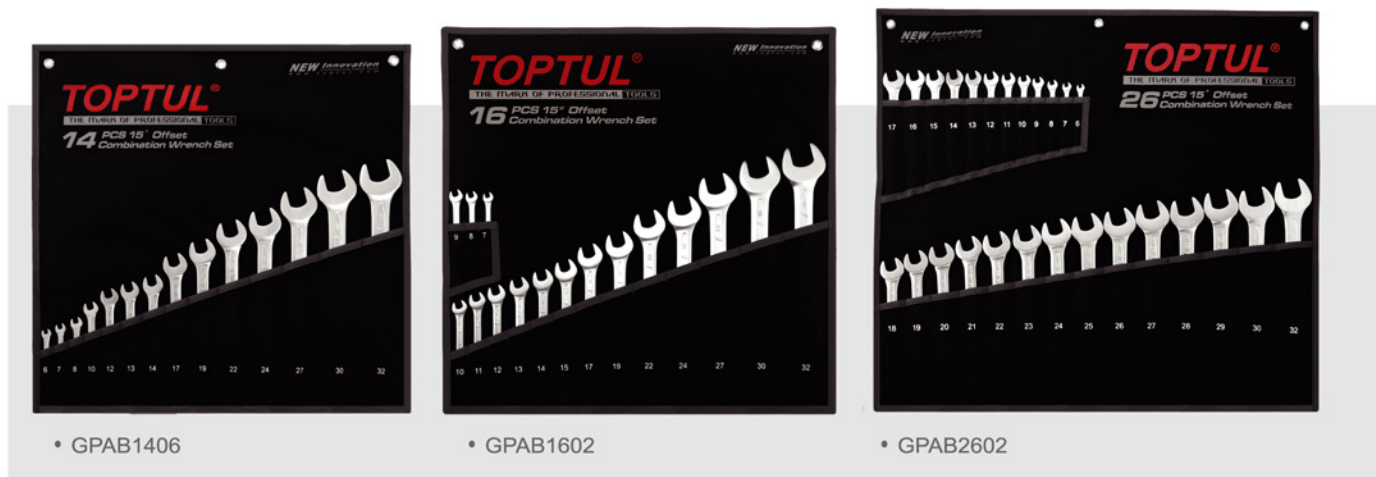

POUCH BAG - BLACK
15° Offset Standard Combination Wrench Set

16PCS

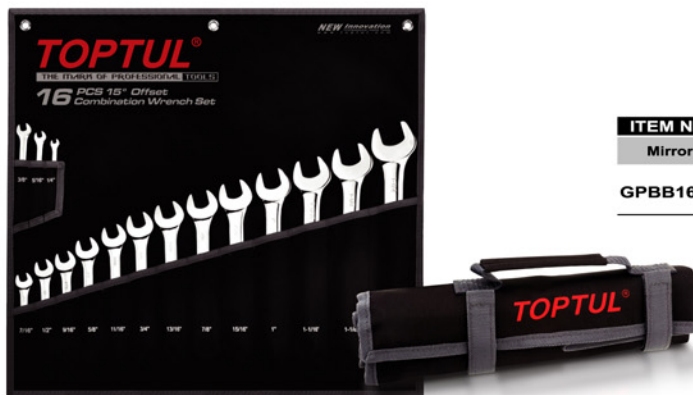

ITEM NO.	CONTENTS	Mirror Polished
Mirror		(SET)
GPBB1601	16 1/4", 5/16", 3/8", 7/16", 1/2", 9/16", 5/8", 11/16", 3/4", 13/16", 7/8", 15/16", 1", 1-1/16", 1-1/8", 1-1/4"	4 (SET)

POUCH BAG - GREEN
15° Offset Standard Combination Wrench Set



ITEM NO.	CONTENTS	Satin Chrome Finished	ITEM NO.	CONTENTS	Satin Chrome Finished
Satin		(SET)	Satin		(SET)
GAAA0804	10, 11, 12, 13, 14, 15, 17, 19	20	GAAA1408	14 8, 9, 10, 11, 12, 13, 14, 15, 16, 17, 19, 21, 22, 24	10
GAAA1213	12 6, 7, 8, 10, 11, 12, 13, 14, 15, 17, 19, 22	10	GAAA1604	16 7, 8, 9, 10, 11, 12, 13, 14, 15, 17, 19, 22, 24, 27, 30, 32	4
GAAA1404	14 8, 10, 11, 12, 13, 14, 15, 17, 19, 22, 24, 27, 30, 32	4	GAAA2604	26 6, 7, 8, 9, 10, 11, 12, 13, 14, 15, 16, 17, 18, 19, 20, 21, 22, 23, 24, 25, 26, 27, 28, 29, 30, 32	3



POUCH BAG - GREEN
15° Offset Standard Combination Wrench Set

16PCS



ITEM NO.	CONTENTS	Mirror Polished
Mirror		(SET)
GBAA1603	16 1/4", 5/16", 3/8", 7/16", 1/2", 9/16", 5/8", 11/16", 3/4", 13/16", 7/8", 15/16", 1", 1-1/16", 1-1/8", 1-1/4"	4 (SET)

71 **Wrenches & Torque Wrenches**

POUCH BAG - GREEN 8PCS

- Chrome Vanadium Steel Material
- 75° offset ring end in design for convenient operation in recess
- High torque performance as over 1.6 times as ANSI & DIN standard



• METRIC

ITEM NO.	SIZE(mm)	L(mm)	Satin Chrome Finished	
			Hand	Box
AAEI0607	6x7	167	10	120
AAEI0809	8x9	182	10	120
AAEI0810	8x10	182	10	120
AAEI1011	10x11	197	10	80
• AAEI1012	10x12	217	10	80
• AAEI1113	11x13	217	10	80
AAEI1213	12x13	218	10	80
AAEI1214	12x14	218	10	80
• AAEI1314	13x14	238	10	80
• AAEI1315	13x15	238	10	80
• AAEI1415	14x15	238	10	80
• AAEI1417	14x17	245	10	80
AAEI1617	16x17	258	5	40
• AAEI1618	16x18	258	5	40
AAEI1719	17x19	290	5	40
AAEI1819	18x19	290	5	40
• AAEI1922	19x22	296	5	40
AAEI2022	20x22	316	5	30
AAEI2123	21x23	316	5	30
AAEI2224	22x24	324	5	30
AAEI2426	24x26	328	5	30
AAEI2427	24x27	328	5	30
AAEI2528	25x28	345	5	30
AAEI2729	27x29	353	2	12
AAEI2730	27x30	353	2	12
AAEI2732	27x32	353	2	12
AAEI3032	30x32	360	2	12
• AAEI3236	32x36	402	2	12
AAEI3436	34x36	440	2	12
AAEI3641	36x41	440	2	12
AAEI3842	38x42	440	2	12
• AAEI4146	41x46	470	2	8
AAEI4650	46x50	510	2	8

POUCH BAG - BLACK 8PCS

- Chrome Vanadium Steel Material
- 75° offset ring end in design for convenient operation in recess
- High torque performance as over 1.6 times as ANSI & DIN standard



• SAE

ITEM NO.	SIZE(inch)	L(mm)	Mirror Polished	
			Hand	Box
ACAI0810	1/4x5/16	167	10	120
ACAI1012	5/16x3/8	182	10	120
ACAI1214	3/8x7/16	197	10	80
ACAI1416	7/16x1/2	217	10	80
ACAI1618	1/2x9/16	238	10	80
ACAI1820	9/16x5/8	238	10	80
ACAI2022	5/8x11/16	258	5	40
ACAI2024	5/8x3/4	258	5	40
ACAI2224	11/16x3/4	290	5	40
ACAI2426	3/4x13/16	296	5	30
ACAI2428	3/4x7/8	296	5	30
ACAI2628	13/16x7/8	316	5	30
ACAI2830	7/8x15/16	324	5	30
ACAI3032	15/16x1	328	5	30
ACAI3436	1-1/16x1-1/8	353	2	12

STORAGE RACK 6PCS

75° Offset Double Ring Wrench Set



ITEM NO.	CONTENTS	Satin Chrome Finished
GAAC0602	6x7, 8x9, 10x11, 12x13, 14x15, 16x17	5 (SET)

POUCH BAG - GREEN 8PCS

75° Offset Double Ring Wrench Set



ITEM NO.	CONTENTS	Satin Chrome Finished
GAAA0810	6x7, 8x9, 10x11, 12x13, 14x15, 16x17, 18x19, 20x22	6 (SET)

POUCH BAG - GREEN 12PCS

75° Offset Double Ring Wrench Set



ITEM NO.	CONTENTS	Satin Chrome Finished
GAAA1204	12x13, 14x15, 16x17, 18x19, 20x22, 21x23, 24x27, 25x28, 30x32	6 (SET)

POUCH BAG - GREEN 10PCS

75° Offset Double Ring Wrench Set

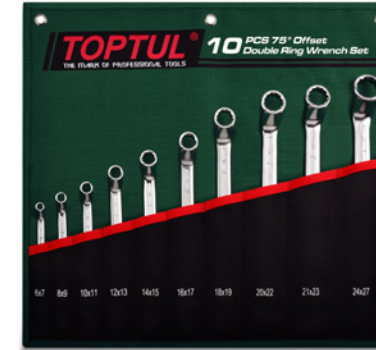

ITEM NO.	CONTENTS	Satin Chrome Finished
GRAI1001	6x7, 8x9, 10x11, 12x13, 14x15, 16x17, 18x19, 20x22, 21x23, 24x27	6 (SET)

POUCH BAG - BLACK 8PCS

75° Offset Double Ring Wrench Set



ITEM NO.	CONTENTS	Satin Chrome Finished
GPAI0802	6x7, 8x9, 10x11, 12x13, 14x15, 16x17, 18x19, 20x22	6 (SET)

POUCH BAG - BLACK 10PCS

75° Offset Double Ring Wrench Set

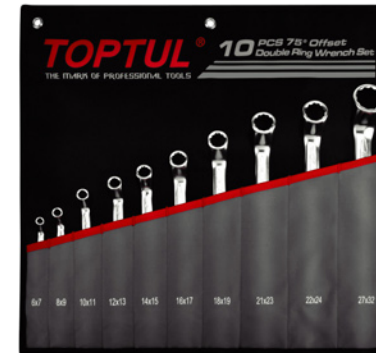

ITEM NO.	CONTENTS	Satin Chrome Finished
GPCI1001	6x7, 8x9, 10x11, 12x13, 14x15, 16x17, 18x19, 21x23, 22x24, 27x32	6 (SET)

POUCH BAG - BLACK 12PCS

75° Offset Double Ring Wrench Set

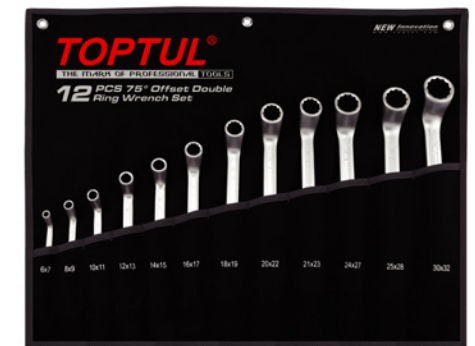

ITEM NO.	CONTENTS	Satin Chrome Finished
GPAI1202	6x7, 8x9, 10x11, 12x13, 14x15, 16x17, 18x19, 20x22, 21x23, 24x27, 25x28, 30x32	6 (SET)

COLOR BOX *

75° Offset Double Ring Wrench Set



ITEM NO.	CONTENTS	Satin Chrome Finished
GAAE0702	8x9, 10x11, 12x13, 14x15, 16x17, 18x19, 20x22	6
GAAE0813	6x7, 8x9, 10x11, 12x13, 14x15, 16x17, 18x19, 20x22	10

METAL BOX *

75° Offset Double Ring Wrench Set



ITEM NO.	CONTENTS	Satin Chrome Finished
GAAD0807	6x7, 8x9, 10x11, 12x13, 14x15, 16x17, 18x19, 20x22	4 (SET)

METAL CASE: W370 x D154 x H50 (mm)

73 **Wrenches & Torque Wrenches**

Double Ring Wrench 45° Offset

- Chrome Vanadium Steel Material
- 45° offset ring end in design for convenient operation in recess
- Professional quality for maximum durability and corrosion resistance



• METRIC

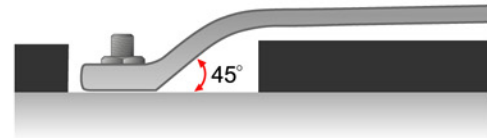

Double Ring Wrench 45° Offset

- Chrome Vanadium Steel Material
- 45° offset ring end in design for convenient operation in recess
- Professional quality for maximum durability and corrosion resistance



• SAE

ITEM NO. Mirror	SIZE(mm)	L(mm)	Mirror Polished	
AAAH0607	6x7	165	10	240
AAAH0809	8x9	170	10	240
AAAH0810	8x10	170	10	240
AAAH1011	10x11	180	10	120
AAAH1012	10x12	195	10	120
AAAH1113	11x13	206	10	80
AAAH1213	12x13	206	10	80
AAAH1214	12x14	206	10	80
AAAH1415	14x15	232	10	80
AAAH1417	14x17	237	10	80
AAAH1617	16x17	237	10	80
AAAH1719	17x19	270	10	80
AAAH1819	18x19	270	10	80
AAAH1921	19x21	292	5	30
AAAH1922	19x22	292	5	30
AAAH2022	20x22	292	5	30
AAAH2123	21x23	327	5	30
AAAH2224	22x24	327	5	30
• AAH2326	23x26	363	5	30
• AAH2426	24x26	363	5	30
• AAH2427	24x27	363	5	30
AAAH2430	24x30	372	5	30
AAAH2528	25x28	372	5	30
• AAH2732	27x32	380	5	30
AAAH3032	30x32	392	2	12
• AAH3641	36x41	440	2	12
• AAH4146	41x46	470	2	8
• AAH4650	46x50	510	2	8
• AAH5560	55x60	610	2	4

ITEM NO. Mirror	SIZE(inch)	L(mm)	Mirror Polished	
ACAH0810	1/4x5/16	165	10	240
ACAH1012	5/16x3/8	170	10	240
ACAH1214	3/8x7/16	180	10	120
ACAH1416	7/16x1/2	206	10	80
ACAH1618	1/2x9/16	206	10	80
ACAH1820	9/16x5/8	232	10	80
ACAH2022	5/8x11/16	237	10	80
ACAH2224	11/16x3/4	270	10	80
ACAH2428	3/4x7/8	292	5	30
ACAH2628	13/16x7/8	292	5	30
ACAH2830	7/8x15/16	327	5	30
ACAH3032	15/16x1	363	5	30
• ACAH3236	1x1-1/8	372	5	30
• ACAH3436	1-1/16x1-1/8	372	5	30
ACAH3440	1-1/16x1-1/4	392	2	12
• ACAH3640	1-1/8x1-1/4	392	2	12

COLOR BOX

45° Offset Double Ring Wrench Set

★ 8PCS



ITEM NO. Mirror	CONTENTS	Mirror Polished	
GAAE0814	6x7, 8x9, 10x11, 12x13, 14x15, 16x17, 18x19, 20x22	10 (SET)	



TOPTUL
Double Ring Wrench 45° Offset

POUCH BAG - GREEN

45° Offset Double Ring Wrench Set

★ 8PCS

POUCH BAG - BLACK

45° Offset Double Ring Wrench Set

8PCS



ITEM NO. Mirror	CONTENTS	Mirror Polished	
GAAA0807	6x7, 8x9, 10x11, 12x13, 14x15, 16x17, 18x19, 20x22	10 (SET)	



ITEM NO. Mirror	CONTENTS	Mirror Polished	
GPAH0801	6x7, 8x9, 10x11, 12x13, 14x15, 16x17, 18x19, 22x24	6 (SET)	

POUCH BAG - GREEN

45° Offset Double Ring Wrench Set

12PCS

POUCH BAG - BLACK

45° Offset Double Ring Wrench Set

8PCS



ITEM NO. Mirror	CONTENTS	Mirror Polished	
GAAA1201	6x7, 8x9, 10x11, 12x13, 14x15, 16x17, 18x19, 20x22, 21x23, 24x27, 25x28, 30x32	4 (SET)	



ITEM NO. Mirror	CONTENTS	Mirror Polished	
GPAH0803	6x7, 8x9, 10x11, 12x13, 14x15, 16x17, 18x19, 20x22	10 (SET)	

POUCH BAG - BLACK

45° Offset Double Ring Wrench Set

12PCS

METAL BOX

45° Offset Double Ring Wrench Set (METRIC)

8PCS



ITEM NO. Mirror	CONTENTS	Mirror Polished	
GAAD0803	6x7, 8x9, 10x11, 12x13, 14x15, 16x17, 18x19, 20x22	4 (SET)	
METAL CASE: W370 x D154 x H50 (mm)			



ITEM NO. Mirror	CONTENTS	Mirror Polished	
GPAH1201	6x7, 8x9, 10x11, 12x13, 14x15, 16x17, 18x19, 20x22, 21x23, 24x27, 25x28, 30x32	4 (SET)	

75 **Wrenches & Torque Wrenches**

- Double Open End Wrench**
- Chrome Vanadium Steel Material
 - Professional quality for maximum durability and corrosion resistance



• METRIC

- Double Open End Wrench**
- Chrome Vanadium Steel Material
 - Professional quality for maximum durability and corrosion resistance



• SAE

ITEM NO.	SIZE(mm)	L(mm)	Satin Chrome Finished	
			Box	Set
AAEJ0405	4x5	99	10	320
AAEJE507	5.5x7	127	10	320
AAEJ0607	6x7	127	10	320
AAEJ0608	6x8	127	10	320
AAEJ0708	7x8	145	10	320
AAEJ0809	8x9	145	10	320
AAEJ0810	8x10	145	10	320
AAEJ0911	9x11	161	10	240
AAEJ1011	10x11	161	10	240
AAEJ1012	10x12	161	10	240
AAEJ1013	10x13	174	10	120
AAEJ1113	11x13	174	10	120
AAEJ1213	12x13	174	10	120
AAEJ1214	12x14	174	10	120
AAEJ1415	14x15	190	10	120
AAEJ1317	13x17	194	10	120
AAEJ1417	14x17	194	10	120
AAEJ1617	16x17	210	10	80
AAEJ1719	17x19	223	10	80
AAEJ1819	18x19	223	10	80
AAEJ1921	19x21	236	10	80
AAEJ1922	19x22	236	10	80
AAEJ2022	20x22	236	10	80
AAEJ2123	21x23	246	10	60
AAEJ2224	22x24	246	10	60
AAEJ2326	23x26	267	5	40
AAEJ2426	24x26	267	5	40
AAEJ2427	24x27	267	5	40
AAEJ2528	25x28	267	5	40
AAEJ2730	27x30	284	5	40
AAEJ2732	27x32	294	5	40
AAEJ3032	30x32	294	5	40
AAEJ3236	32x36	325	2	12
AAEJ3436	34x36	325	2	12
AAEJ3641	36x41	377	2	12
AAEJ4146	41x46	426	2	12
AAEJ4650	46x50	477	2	10
AAEJ5055	50x55	504	2	8
AAEJ5560	55x60	504	2	8

ITEM NO.	SIZE(inch)	L(mm)	Mirror Polished	
			Box	Set
ACAJ0810	1/4x5/16	127	10	320
ACAJ1012	5/16x3/8	145	10	320
ACAJ1214	3/8x7/16	161	10	320
ACAJ1416	7/16x1/2	174	10	120
ACAJ1618	1/2x9/16	174	10	120
ACAJ1820	9/16x5/8	190	10	120
ACAJ2022	5/8x11/16	210	10	80
ACAJ2224	11/16x3/4	223	10	80
ACAJ2428	3/4x7/8	236	10	80
ACAJ2628	13/16x7/8	236	10	80
ACAJ3032	15/16x1	267	5	40
ACAJ3236	1x1-1/8	267	5	40
ACAJ3440	1-1/16x1-1/4	294	5	40

ITEM NO.	SIZE(inch)	L(mm)	Satin Chrome Finished	
			Box	Set
ACAJ4248	1-5/16x1-1/2	325	2	12

- POUCH BAG - GREEN** 8PCS Double Open End Wrench Set

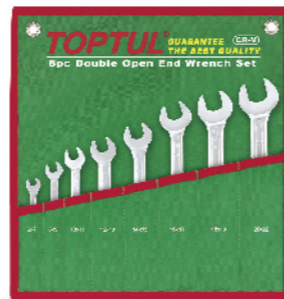

ITEM NO.	CONTENTS	Satin Chrome Finished
GAAA0812	6x7, 8x9, 10x11, 12x13, 14x15, 16x17, 18x19, 20x22	20 (SET)

- COLOR BOX** 8PCS Double Open End Wrench Set



ITEM NO.	CONTENTS	Satin Chrome Finished
GAAE0817	6x7, 8x9, 10x11, 12x13, 14x15, 16x17, 18x19, 20x22	10 (SET)

- POUCH BAG - GREEN** 12PCS Double Open End Wrench Set



ITEM NO.	CONTENTS	Satin Chrome Finished
GAAA1206	12 6x7, 8x9, 10x11, 12x13, 14x15, 16x17, 18x19, 20x22, 21x23, 24x27, 25x28, 30x32	6 (SET)

- POUCH BAG - BLACK** 10PCS Double Open End Wrench Set



ITEM NO.	CONTENTS	Satin Chrome Finished
GPCJ1001	10 6x7, 8x9, 10x11, 12x13, 14x15, 16x17, 18x19, 20x22, 24x27, 30x32	10 (SET)



- POUCH BAG - BLACK** 8PCS Double Open End Wrench Set



ITEM NO.	CONTENTS	Satin Chrome Finished
GPAJ0802	6x7, 8x9, 10x11, 12x13, 14x15, 16x17, 18x19, 20x22	20 (SET)

- STORAGE RACK** 8PCS Double Open End Wrench Set

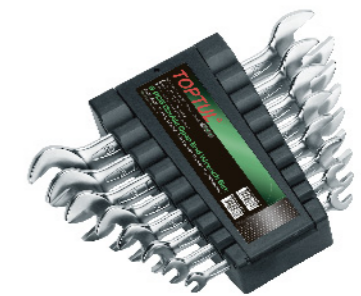

ITEM NO.	CONTENTS	Satin Chrome Finished
GAAC0802	6x7, 8x9, 10x11, 12x13, 14x15, 16x17, 18x19, 20x22	5 (SET)

- POUCH BAG - BLACK** 12PCS Double Open End Wrench Set



ITEM NO.	CONTENTS	Satin Chrome Finished
GPAJ1202	12 6x7, 8x9, 10x11, 12x13, 14x15, 16x17, 18x19, 20x22, 21x23, 24x27, 25x28, 30x32	6 (SET)

- METAL BOX** 10PCS Double Open End Wrench Set



ITEM NO.	CONTENTS	Satin Chrome Finished
GAAD1009	10 6x7, 8x9, 10x11, 12x13, 14x15, 16x17, 18x19, 20x22, 21x23, 24x27	4 (SET)

METAL CASE: W370 x D154 x H50 (mm)

77 Wrenches & Torque Wrenches

Standard Combination Wrench 75° Offset

- Chrome Vanadium Steel Material
- Professional quality for maximum durability and corrosion resistance
- 75° offset ring end in design for operating easily in recess

CR-V Steel
Satin Chrome Finish
Industrial DIN Standard

With 75° offset in design, this wrench will overcome the operational restriction compared with the traditional type combination wrench

Robust construction & Precision machining
Maximum tool torque and durability



COLOR BOX ★ 8PCS

75° Offset Standard Combination Wrench Set

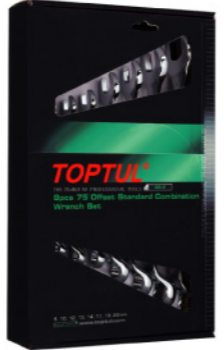

ITEM NO.	SIZE(mm)	L(mm)	Satin Chrome Finished	
Satin				
AAEN0606	6	110	10	320
AAEN0707	7	120	10	320
AAEN0808	8	130	10	320
AAEN0909	9	140	10	320
AAEN1010	10	150	10	160
AAEN1111	11	160	10	240
AAEN1212	12	170	10	160
AAEN1313	13	180	10	120
AAEN1414	14	190	10	120
AAEN1515	15	205	10	80
AAEN1616	16	215	10	80
AAEN1717	17	225	10	80
AAEN1818	18	235	10	80
AAEN1919	19	255	5	40
AAEN2020	20	255	5	40
AAEN2121	21	285	5	40
AAEN2222	22	285	5	40
AAEN2323	23	315	5	30
AAEN2424	24	315	5	30
AAEN2525	25	345	5	30
AAEN2626	26	345	5	30
AAEN2727	27	365	2	12
AAEN2828	28	365	2	12
AAEN2929	29	395	2	12
AAEN3030	30	395	2	12
AAEN3232	32	415	2	12

ITEM NO.	CONTENTS	Satin Chrome Finished
Satin		10 (SET)
GAAE0811	8, 10, 12, 13, 14, 17, 19, 22	

POUCH BAG - BLACK ★ 12PCS

75° Offset Standard Combination Wrench Set



ITEM NO.	CONTENTS	Satin Chrome Finished
Satin		6 (SET)
GPAN1201	8, 10, 11, 12, 13, 14, 16, 17, 18, 19, 21, 22	



TOPTUL
STANDARD COMBINATION WRENCH 75° OFFSET

Midget Combination Wrench 15° Offset

- Chrome Vanadium Steel Material
- Short shank in design for convenient operation in confined area
- Professional quality for maximum durability and corrosion resistance



ITEM NO.	SIZE(mm)	L(mm)	Mirror Polished	
Mirror				
AAAF0707	7	86	10	320
AAAF0808	8	86	10	320
AAAF0909	9	95	10	320
AAAF1010	10	95	10	320
AAAF1111	11	99	10	320
AAAF1212	12	103	10	320
AAAF1313	13	107	10	320
AAAF1414	14	113	10	160
AAAF1515	15	117	10	160
AAAF1616	16	121	10	160
AAAF1717	17	127	10	120
AAAF1818	18	131	10	120
AAAF1919	19	137	10	120

Midget Combination Wrench 15° Offset ★

- Chrome Vanadium Steel Material
- Short shank in design for convenient operation in confined area
- Professional quality for maximum durability and corrosion resistance



ITEM NO.	SIZE(inch)	L(mm)	Mirror Polished	
Mirror				
ACAF1010	5/16	86	10	320
ACAF1111	11/32	95	10	320
ACAF1212	3/8	95	10	320
ACAF1414	7/16	99	10	320
ACAF1616	1/2	107	10	320
ACAF1818	9/16	113	10	160
ACAF2020	5/8	121	10	160
ACAF2222	11/16	127	10	120
ACAF2424	3/4	137	10	120

POUCH BAG - GREEN ★ 10PCS

15° Offset Midget Combination Wrench Set

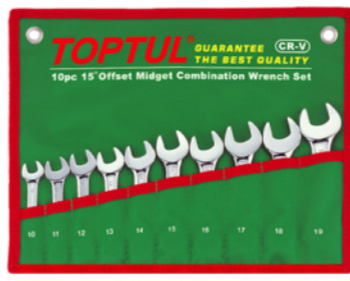

ITEM NO.	CONTENTS	Mirror Polished
Mirror		20 (SET)
GAAA1001	10, 11, 12, 13, 14, 15, 16, 17, 18, 19	

MIDGET DOUBLE RING WRENCH 45° OFFSET



Midget Double Ring Wrench 45° Offset

- Chrome Vanadium Steel Material
- Short shank allows convenient operation in confined area
- Professional quality for maximum durability and corrosion resistance



ITEM NO.	SIZE(mm)	L(mm)	Mirror Polished	
Mirror				
AAAK1011	10x11	116	10	160
AAAK1213	12x13	141	10	160
AAAK1415	14x15	141	10	160
AAAK1617	16x17	158	10	120
AAAK1819	18x19	158	10	120

10PCS Miniature Combination Wrench Set



ITEM NO.	CONTENTS	Mirror Polished
Mirror		10 (SET)
GBBA1001	10 AFAM0505~1414 5/32", 3/16" 7/32", 15/64", 1/4", 9/32", 5/16", 11/32", 3/8", 7/16"	



Mirror Polished

10 AFAM0505~1414
5/32", 3/16"
7/32", 15/64", 1/4", 9/32", 5/16", 11/32", 3/8", 7/16"

79 **Wrenches & Torque Wrenches**

Star Wrench

- Chrome Vanadium Steel Material
- Useful for removing E-Torx fasteners
- Professional quality for maximum durability and corrosion resistance



ITEM NO.	SIZE	L(mm)	Satin Chrome Finished	
			Icon 1	Icon 2
AAEE0608	E6xE8	113	10	320
AAEE0711	E7xE11	127	10	320
AAEE1012	E10xE12	142	10	320
AAEE1418	E14xE18	181	10	240
AAEE1622	E16xE22	204	5	40
AAEE2024	E20xE24	224	5	40

Half-Moon Ring Wrench

- Chrome Vanadium Steel Material
- Special purpose tool for hard to reach starter bolts
- Professional quality for maximum durability and corrosion resistance

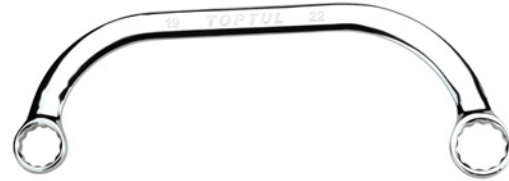

ITEM NO.	SIZE(mm)	L(mm)	Mirror Polished	
			Icon 1	Icon 2
AAAC0809	8x9	137	10	160
AAAC1012	10x12	142	10	160
AAAC1113	11x13	166	5	80
AAAC1417	14x17	190	5	80
AAAC1618	16x18	220	5	40
AAAC1922	19x22	256	5	40

Flat Type Extra-Long Double Ring Wrench

- Chrome Molybdenum Steel Material
- Professional quality for maximum durability and corrosion resistance
- Long shank and thin wall ring end design for reaching bolts easily in deep restricted space



ITEM NO.	SIZE(mm)	L(mm)	Mirror Polished	
			Icon 1	Icon 2
AAAP0810	8x10	230	15	120
AAAP1012	10x12	300	15	90
AAAP1214	12x14	333	10	60
AAAP1417	14x17	365	10	60
AAAP1719	17x19	400	5	30
AAAP2224	22x24	430	5	30

6PT - Flare Nut Wrench

- Chrome Vanadium Steel Material
- Thick head feature ensures a strong grip on the nut and avoids damages
- Useful for tightening and loosening flare nuts at line connections
- Specially designed for use with nuts fitted in hydraulic, oil and compressed air systems



ITEM NO.	SIZE(mm)	L(mm)	Satin Chrome Finished	
			Icon 1	Icon 2
AEAA0809	8x9	130	15	240
AEAA0810	8x10	130	15	240
AEAA1011	10x11	150	10	160
AEAA1012	10x12	150	10	160
AEAA1113	11x13	170	10	120
AEAA1213	12x13	170	10	120
AEAA1214	12x14	170	10	120

POUCH BAG - BLACK

Flat Type Extra-Long Double Ring Wrench Set

6PCS



ITEM NO.	CONTENTS	Mirror Polished
GPAP0601	8x10, 10x12, 12x14, 14x17, 17x19, 22x24	Icon 1 12 (SET)

6PT - Flare Nut Wrench

- Chrome Vanadium Steel Material
- Thick head feature ensures a strong grip on the nut and avoids damages
- Useful for tightening and loosening flare nuts at line connections
- Specially designed for use with nuts fitted in hydraulic, oil and compressed air systems



ITEM NO.	SIZE(inch)	L(mm)	Mirror Polished	
			Icon 1	Icon 2
AFAA1012	5/16x3/8	130	15	240
AFAA1214	3/8x7/16	150	10	160
AFAA1416	7/16x1/2	170	10	120
AFAA1618	1/2x9/16	170	10	120

12PT - Flare Nut Wrench

- Chrome Vanadium Steel Material
- Thick head feature ensures a strong grip on the nut and avoids damages
- Useful for tightening and loosening flare nuts at line connections
- Specially designed for use with nuts fitted in hydraulic, oil and compressed air systems



ITEM NO.	SIZE(mm)	L(mm)	Satin Chrome Finished	
			Icon 1	Icon 2
AEAA1417	14x17	190	5	60
AEAA1618	16x18	210	5	40
AEAA1719	17x19	210	5	40
AEAA1922	19x22	230	5	40
AEAA2224	22x24	252	5	40
AEAA2427	24x27	265	5	40

12PT - Flare Nut Wrench

- Chrome Vanadium Steel Material
- Thick head feature ensures a strong grip on the nut and avoids damages
- Useful for tightening and loosening flare nuts at line connections
- Specially designed for use with nuts fitted in hydraulic, oil and compressed air systems



ITEM NO.	SIZE(inch)	L(mm)	Mirror Polished	
			Icon 1	Icon 2
AFAA1820	9/16x5/8	190	5	60
AFAA2224	11/16x3/4	210	5	40
AFAA2428	3/4x7/8	230	5	40

POUCH BAG - BLACK

Flare Nut Wrench Set

5PCS



ITEM NO.	CONTENTS	Satin Chrome Finished
GPAQ0502	8x10, 11x13, 12x14, 17x19, 22x24	Icon 1 10 (SET)

Angled Socket Wrench

- Chrome Vanadium Steel Material
- Unique designed open hole on the angle socket end allows access to nuts fitted onto protruding threads

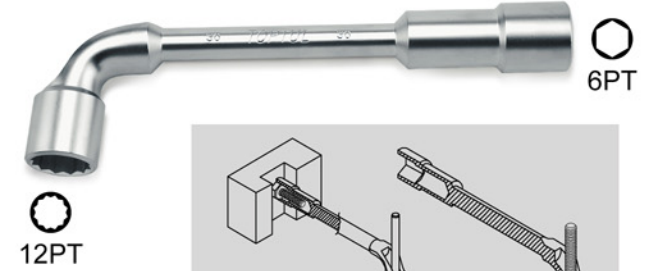

ITEM NO.	SIZE(mm)	L(mm)	Satin Chrome Finished	
			Icon 1	Icon 2
AEAE0606	6	105	10	320
AEAE0707	7	106	10	320
AEAE0808	8	126	10	160
AEAE0909	9	127	10	160
AEAE1010	10	143	10	160
AEAE1111	11	143	10	160
AEAE1212	12	154	5	60
AEAE1313	13	155	5	60
AEAE1414	14	176	5	60
AEAE1515	15	171	5	60
AEAE1616	16	197	5	40
AEAE1717	17	198	5	40
AEAE1818	18	213	5	40
AEAE1919	19	214	2	16
AEAE2020	20	220	2	16
AEAE2121	21	220	2	16
AEAE2222	22	241	2	16
AEAE2323	23	242	2	12
AEAE2424	24	242	2	12
AEAE2525	25	243	2	12
AEAE2626	26	278	2	12
AEAE2727	27	278	2	12
AEAE2828	28	289	2	12
AEAE2929	29	295	2	12
AEAE3030	30	316	2	12
AEAE3232	32	327	2	12

POUCH BAG - BLACK

Angled Socket Wrench Set

9PCS



ITEM NO.	CONTENTS	Satin Chrome Finished
GPAQ0901	8, 10, 11, 12, 13, 14, 16, 17, 19	Icon 1 6 (SET)

81 **Wrenches & Torque Wrenches**

Swivel-Socket Combination Wrench

- Chrome Vanadium Steel Material
- Unique swivel function in design enables the socket end to rotate through 180° moment for convenient access to confined area



12PT

ITEM NO.	SIZE(mm)	L(mm)	Satin Chrome Finished	
			📦	📦
AEEB0808	8	170	20	240
AEEB0909	9	170	20	240
AEEB1010	10	180	15	180
AEEB1111	11	190	10	120
AEEB1212	12	195	10	120
AEEB1313	13	210	10	80
AEEB1414	14	223	10	80
AEEB1515	15	223	10	80
AEEB1616	16	235	5	40
AEEB1717	17	235	5	40
AEEB1818	18	255	5	40
AEEB1919	19	255	5	40

1/4" Square Drive & Bit Holder Swivel Wrench

- Chrome Vanadium Steel Material
- Swivel head design for working in areas with restricted access

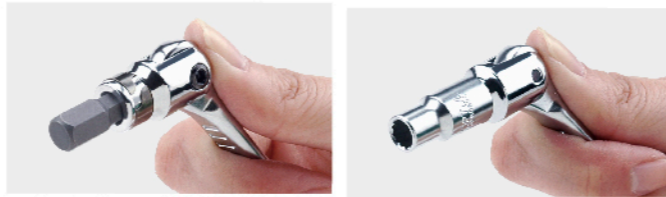

• Quick Change 1/4" (Hex) Bit Holder • 1/4" Drive Socket Adaptor

ITEM NO.	SIZE	L(mm)	Dual Finished	
			📦	📦
AREA0808	1/4" Dr. x 1/4"	185	10	80

Pro-Series Reversible Ratchet Combination Wrench

- Chrome Vanadium Steel Material
- Two-way reversible gear design for quick and easy fastening and loosening works
- 72 teeth ratchet mechanism, 5° increments
- High torque & durable ratcheting performance
- Stain chrome plated finish



ITEM NO.	SIZE(mm)	L(mm)	Satin Chrome Finished	
			📦	📦
ABAF0808	8	140	10	320
ABAF0909	9	149	10	320
ABAF1010	10	158	10	160
ABAF1111	11	165	10	120
ABAF1212	12	171	10	120
ABAF1313	13	178	10	120
ABAF1414	14	190	10	120
ABAF1515	15	199	10	80
ABAF1616	16	208	10	80
ABAF1717	17	225	10	80
ABAF1818	18	236	10	80
ABAF1919	19	247	10	80

METAL BOX Pro-Series Reversible Ratchet Combination Wrench Set 15PCS



ITEM NO.	Black	GBA1541	★ Green	GRA1541	Satin Chrome Finished	
					📦	📦
CONTENTS						
12 ABAF0808-1919						
72 Teeth Pro-Series Reversible Ratchet Combination Wrenches						
8, 9, 10, 11, 12, 13, 14, 15, 16, 17, 18, 19 mm						
3 CANA0810-1619						
Socket Adapter with Quick Release (For Ratchet Wrench)						
1/4" x 10mm, 3/8" x 13mm, 1/2" x 19mm						
METAL CASE: W361 x D137 x H53 (mm)						

Double End Swivel-Socket Wrench

- Chrome Vanadium Steel Material
- Unique swivel function in design enables the socket end to rotate through 180° moment for convenient access to confined area



12PT

ITEM NO.	SIZE(mm)	L(mm)	Satin Chrome Finished	
			📦	📦
AEEC0607	6x7	185	10	240
AEEC0809	8x9	185	10	160
AEEC0810	8x10	185	10	160
AEEC1011	10x11	200	10	80
AEEC1012	10x12	205	10	80
AEEC1213	12x13	220	10	80
AEEC1214	12x14	225	10	80
AEEC1415	14x15	242	10	80
AEEC1417	14x17	244	10	80
AEEC1617	16x17	258	5	40
AEEC1719	17x19	260	5	40
AEEC1819	18x19	270	5	40
AEEC2022	20x22	305	5	30
AEEC2123	21x23	305	5	30

METAL BOX Double End Swivel-Socket Wrench Set 7PCS



ITEM NO.	CONTENTS	Satin Chrome Finished
GAAD0703	7 6x7, 8x9, 10x11, 12x13, 14x15, 16x17, 18x19	📦 4 (SET)
METAL CASE: W370 x D154 x H50 (mm)		

STORAGE RACK Pro-Series Reversible Ratchet Combination Wrench Set 7PCS



ITEM NO.	CONTENTS	Satin Chrome Finished
GAAM0709	7 8, 10, 12, 13, 14, 17, 19	📦 2 (SET)

METAL BOX Pro-Series Reversible Ratchet Combination Wrench Set 12PCS



ITEM NO.	CONTENTS	Satin Chrome Finished
GAAD1205	12 8, 9, 10, 11, 12, 13, 14, 15, 16, 17, 18, 19	📦 4 (SET)
METAL CASE: W370 x D154 x H50 (mm)		

POUCH BAG - BLACK Double End Swivel-Socket Wrench Set 7PCS



ITEM NO.	CONTENTS	Satin Chrome Finished
GPAQ0701	7 6x7, 8x9, 10x11, 12x13, 14x15, 16x17, 18x19	📦 10 (SET)

POUCH BAG - GREEN Double End Swivel-Socket Wrench Set 7PCS



ITEM NO.	CONTENTS	Satin Chrome Finished
GAAA0704	7 6x7, 8x9, 10x11, 12x13, 14x15, 16x17, 18x19	📦 10 (SET)

POUCH BAG - BLACK Pro-Series Reversible Ratchet Combination Wrench Set 12PCS

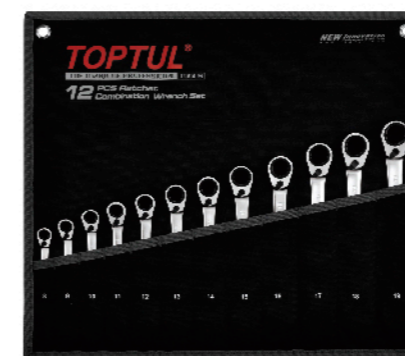

ITEM NO.	CONTENTS	Satin Chrome Finished
GPAQ1203	12 8, 9, 10, 11, 12, 13, 14, 15, 16, 17, 18, 19	📦 10 (SET)





Improved Box End Strength & Durability
5° Operating Angle

Strong Open End Design
DIN Standard

Chrome Vanadium Alloy Steel
Satin Chrome Finish

HIGH PERFORMANCE
RATCHET COMBINATION WRENCH

Pro-Series Ratchet Combination Wrench

- Chrome Vanadium Steel Material
- 72 teeth ratchet mechanism, 5° increments
- High torque & durable ratcheting performance
- Stain chrome plated finish



ITEM NO.	SIZE(mm)	L(mm)	Hand	Weight (kg)	Weight (lb)
AOAF0808	8	140	10	10	320
AOAF0909	9	149	10	10	160
AOAF1010	10	158	10	10	160
AOAF1111	11	165	10	10	120
AOAF1212	12	171	10	10	120
AOAF1313	13	178	10	10	120
AOAF1414	14	190	10	10	120
AOAF1515	15	200	10	10	80
AOAF1616	16	208	10	10	80
AOAF1717	17	225	10	10	80
AOAF1818	18	236	10	10	80
AOAF1919	19	247	10	10	80
AOAF2222	22	289	5	5	40
AOAF2424	24	322	5	5	40

POUCH BAG - BLACK 12PCS
Ratchet Combination Wrench Set



ITEM NO.	CONTENTS	Weight (kg)	Weight (lb)
GPAQ1202	12 8, 9, 10, 11, 12, 13, 14, 15, 16, 17, 18, 19	10 (SET)	

METAL BOX 8PCS
Pro-Series Ratchet Combination Wrench Set



ITEM NO.	CONTENTS	Weight (kg)	Weight (lb)
GAAD0810	8, 10, 11, 12, 13, 14, 17, 19	4 (SET)	

BLOW CASE: W260 x D170 x H60 (mm) METAL CASE: W370 x D154 x H50 (mm)

Pro-Series Ratchet Double Ring Wrench

- Chrome Vanadium Steel Material
- 72 teeth ratchet mechanism, 5° increments
- High torque & durable ratcheting performance



ITEM NO.	SIZE(mm)	L(mm)	Hand	Weight (kg)	Weight (lb)
AOAG0809	8x9	128	10	10	320
AOAG1011	10x11	150	10	10	160
AOAG1213	12x13	170	10	10	160
AOAG1415	14x15	190	10	10	120
AOAG1618	16x18	210	10	10	80
AOAG1719	17x19	230	10	10	80

Pro-Series 4-In-1 Ratchet Double Ring Wrench

- Chrome Vanadium Steel Material
- Two-way reversible gear design for quick and easy fastening and loosening works
- 72 teeth ratchet mechanism, 5° increments
- High torque & durable ratcheting performance



ITEM NO.	SIZE(mm)	L(mm)	Hand	Weight (kg)	Weight (lb)
ABAD0811	8x11-10x9	150	10	10	160
ABAD1215	12x15-14x13	190	5	5	80
ABAD1619	16x19-17x18	230	5	5	40



Pro-Series 4-In-1 Ratchet Double Ring Wrench

Reversible Ratchet Combination Wrench

- Chrome Vanadium Steel Material
- Two-way reversible gear design for quick and easy fastening and loosening works
- 72 teeth gear construction for optimum fastening efficiency with only 5° increment of a turn



ITEM NO.	SIZE(mm)	L(mm)	Hand	Weight (kg)	Weight (lb)
ABEA0808	8	135	10	10	320
ABEA0909	9	145	10	10	320
ABEA1010	10	155	10	10	160
ABEA1111	11	165	10	10	120
ABEA1212	12	175	10	10	120
ABEA1313	13	185	10	10	120
ABEA1414	14	195	10	10	120
ABEA1515	15	205	10	10	80
ABEA1616	16	215	10	10	80
ABEA1717	17	225	10	10	80
ABEA1818	18	235	10	10	80
ABEA1919	19	245	10	10	80

Reversible Ratchet Combination Wrench

- Chrome Vanadium Steel Material
- Two-way reversible gear design for quick and easy fastening and loosening works
- 72 teeth gear construction for optimum fastening efficiency with only 5° increment of a turn



ITEM NO.	SIZE(inch)	L(mm)	Hand	Weight (kg)	Weight (lb)
ADAA1010	5/16	135	10	10	320
ADAA1212	3/8	155	10	10	160
ADAA1414	7/16	165	10	10	120
ADAA1616	1/2	185	10	10	120
ADAA1818	9/16	195	10	10	120
ADAA2020	5/8	215	10	10	80
ADAA2222	11/16	225	10	10	80
ADAA2424	3/4	245	10	10	80

METAL BOX 8PCS
Reversible Ratchet Combination Wrench Set (SAE)



ITEM NO.	CONTENTS	Weight (kg)	Weight (lb)
GBAD0802	5/16", 3/8", 7/16", 1/2", 9/16", 5/8", 11/16", 3/4"	4 (SET)	

METAL CASE: W370 x D154 x H50 (mm)

85 **Wrenches & Torque Wrenches**

Flexible Ratchet Combination Wrench

- Chrome Vanadium Steel Material
- 72 Teeth Ratchet Mechanism (5° increments)
- Satin Chrome Finished
- The pivoting flexible ratchet ring head allows for 180 degree operation in confined spaces
- Compact ring head enables to work in tight spaces where a ratchet and socket would not fit
- Ideal for applications that present problems in terms of congestion, visibility and accessibility



ITEM NO.	SIZE(mm)	L(mm)	Satin Chrome Finished	
			Hand	Box
AOAD0808	8	136	10	320
AOAD0909	9	158	10	320
AOAD1010	10	158	10	160
AOAD1111	11	175	10	120
AOAD1212	12	175	10	120
AOAD1313	13	185	10	120
AOAD1414	14	193	10	120
AOAD1515	15	213	10	80
AOAD1616	16	213	10	80
AOAD1717	17	231	10	80
AOAD1818	18	249	10	80
AOAD1919	19	249	10	80

10PCS Flexible Ratchet Combination Wrench Set



ITEM NO.	CONTENTS	Satin Chrome Finished
GAAI1003	6 AOAD0808~1919 Flexible Ratchet Combination Wrenches 8, 10, 12, 13, 17, 19 mm 3 CANA0810~1619 Socket Adapter with Quick Release (For Ratchet Wrench) 1/4" x 10mm, 3/8" x 13mm, 1/2" x 19mm 1 FTAB0810 Quick Change Bit Holder 1/4" x 10mm	10 (SET)

BLOW CASE: W260 x D170 x H60 (mm)



POUCH BAG - BLACK Flexible Ratchet Combination Wrench Set 12PCS

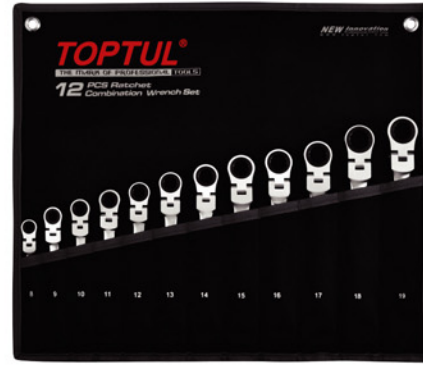

ITEM NO.	CONTENTS	Satin Chrome Finished
GPAQ1204	12 8, 9, 10, 11, 12, 13, 14, 15, 16, 17, 18, 19	10 (SET)

Ratchet Combination Wrench

- Chrome Vanadium Steel Material
- 72 Teeth Ratchet Mechanism



ITEM NO.	SIZE(mm)	L(mm)	Satin Chrome Finished	
			Hand	Box
AOAA0808	8	135	10	320
AOAA0909	9	158	10	160
AOAA1010	10	158	10	120
AOAA1111	11	164	10	120
AOAA1212	12	167	10	120
AOAA1313	13	176	10	120
AOAA1414	14	190	10	120
AOAA1515	15	199	10	80
AOAA1616	16	205	10	80
AOAA1717	17	223	10	80
AOAA1919	19	245	10	80
AOAA2222	22	278	5	40
AOAA2424	24	308	5	40

10PCS Ratchet Combination Wrench Set



ITEM NO.	CONTENTS	Satin Chrome Finished
GAAI1002	6 AOAA0808-1919 Ratchet Combination Wrenches 8, 10, 12, 13, 17, 19 mm 3 CANA0810~1619 Socket Adapter with Quick Release (For Ratchet Wrench) 1/4" x 10mm, 3/8" x 13mm, 1/2" x 19mm 1 FTAB0810 Quick Change Bit Holder 1/4" x 10mm	12 (SET)

BLOW CASE: W280 x D190 x H50 (mm)

Stubby Ratchet Combination Wrench

- Chrome Vanadium Steel Material
- 72 Teeth Ratchet Mechanism



ITEM NO.	SIZE(mm)	L(mm)	Satin Chrome Finished	
			Hand	Box
AOAB0808	8	93	10	320
AOAB0909	9	95	10	320
AOAB1010	10	95	10	320
AOAB1111	11	105	10	320
AOAB1212	12	105	10	320
AOAB1313	13	106	10	320
AOAB1414	14	115	10	160
AOAB1515	15	122	10	160
AOAB1616	16	122	10	160
AOAB1717	17	125	10	120
AOAB1818	18	138	10	120
AOAB1919	19	138	10	120

Ratchet Double Ring Wrench

- Chrome Vanadium Steel and special heat treatments provides thin walls for strength
- 72 teeth ratcheting system provides high torque and 5 degrees of operation in tight areas



ITEM NO.	SIZE(mm)	L(mm)	Satin Chrome Finished	
			Hand	Box
AEAR0809	8x9	131	10	320
AEAR1011	10x11	144	10	160
AEAR1213	12x13	166	10	160
AEAR1415	14x15	181	10	120
AEAR1618	16x18	206	10	80
AEAR1719	17x19	224	10	80

Ratchet Double E-Star Ring Wrench

- Chrome Vanadium Steel Material
- Useful for removing external E-star fasteners quickly
- 72 teeth ratcheting mechanism for optimum fastening efficiency



ITEM NO.	SIZE	L(mm)	Satin Chrome Finished	
			Hand	Box
AOAC0608	E6xE8	130	10	160
AOAC1012	E10xE12	144	10	160
AOAC1418	E14xE18	181	10	80
AOAC2024	E20xE24	224	10	80

Flexible Ratchet Double Ring Wrench

- Chrome Vanadium Steel Material
- 72 teeth ratchet mechanism (5° increments)
- Satin chrome finished
- The pivoting flexible ratchet ring head allows for 180 degree operation in confined spaces
- Compact ring head enables to work in tight spaces where a ratchet and socket would not fit
- Ideal for applications that present problems in terms of congestion, visibility and accessibility



ITEM NO.	SIZE(mm)	L(mm)	Satin Chrome Finished	
			Hand	Box
AOAE0809	8x9	182	10	120
AOAE1011	10x11	188	10	120
AOAE1213	12x13	213	10	80
AOAE1415	14x15	225	10	80
AOAE1618	16x18	235	10	80
AOAE1719	17x19	238	10	80

Socket Adapter With Quick Release (For Ratchet Wrench)

CR-V DIN3123



ITEM NO.	DRIVE	L(mm)	Mirror Polished	
			Hand	Box
CANA0810	1/4" x 10mm	20	10	180
CANA1213	3/8" x 13mm	24	10	180
CANA1619	1/2" x 19mm	32	10	180

Quick Change Bit Holder (For Ratchet Wrench)

CR-V

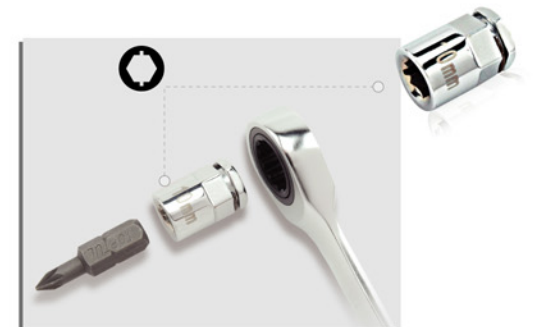

ITEM NO.	DRIVE	L(mm)	Mirror Polished	
			Hand	Box
FTAB0810	1/4" x 10mm	17	50	800

87 Wrenches & Torque Wrenches

Adjustable Hook Spanner Wrench

- Made of Chrome Vanadium Alloy Steel
- Ideal for adjusting collars, lock nut rings and bearings
- Five sizes cover the full range of conventional fixed wrenches

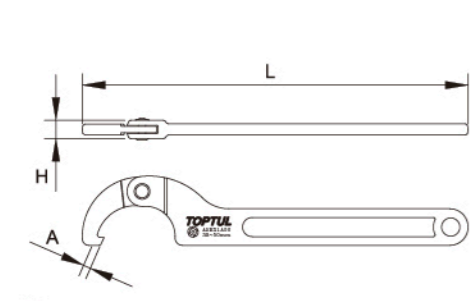
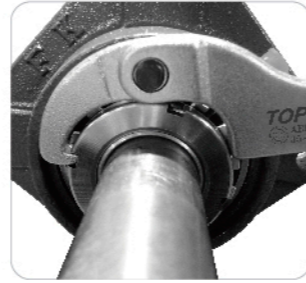
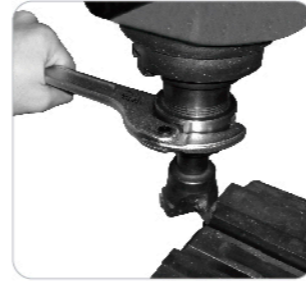

ITEM NO.	Diameter Capacity (mm)	Hook Depth (A) (mm)	Hook Thickness (H) (mm)	Overall Length (L) (mm)	Satin Finished	
AEEX1A35	13-35	3.5	9	170	5	60
AEEX1A50	35-50	4.5	10	215	5	40
AEEX1A80	50-80	5.5	12	285	5	40
AEEX1AA2	80-120	6.0	13	345	5	30
AEEX1AA8	120-180	8.0	15	465	2	8

Double Socket Ratchet Wrench

- Chrome Vanadium Steel Material
- Two-way reversible gear design for quick and easy fastening and loosening works



ITEM NO.	SIZE(mm)	L(mm)	Satin Finished	
AEAH1013	10x13	240	2	50
AEAH1214	12x14	240	2	50
AEAH1317	13x17	280	2	50
AEAH1417	14x17	280	2	50
AEAH1719	17x19	315	2	40
AEAH1721	17x21	315	2	40
AEAH1921	19x21	315	2	40
AEAH1922	19x22	315	2	40
AEAH1924	19x24	360	2	24
AEAH2123	21x23	360	2	24
AEAH2224	22x24	360	2	24
AEAH2427	24x27	360	2	24
AEAH2430	24x30	450	2	12
AEAH2730	27x30	450	2	12
AEAH2732	27x32	450	2	12
AEAH3032	30x32	450	2	12
AEAH3236	32x36	450	2	12
AEAH3641	36x41	450	2	12
AEAH4146	41x46	500	2	8
AEAH4650	46x50	500	2	8
AEAH4655	46x55	500	2	8
AEAH5055	50x55	500	2	8

Open-End Ratcheting Wrench

- Chrome Molybdenum Steel Open-End
- Chrome Vanadium Steel Handle
- Special purpose tool for hard to reach starter bolts
- Professional quality for maximum durability and corrosion resistance



ITEM NO.	SIZE(mm)	L(mm)	Satin Finished	
AEAT1010	10	156	10	160
AEAT1111	11	156	10	160
AEAT1313	13	156	10	160
AEAT1717	17	210	10	80
AEAT1919	19	212	10	80
AEAT2222	22	220	10	80

Aluminum Alloy Pipe Wrench

- Aluminum alloy body
- Chrome molybdenum jaw
- Extra hardened jaw and deep milled teeth provide maximum strength at stress point
- Balanced for proper weight distribution



ITEM NO.	SIZE/LENGTH (inch)	JAW OPENING CAPACITY Ø (inch)	Satin Finished	
DDAC1A14	14	2	2	8
DDAC1A18	18	2-1/2	2	4
DDAC1A24	24	3	2	4
DDAC1A36	36	5	1	2
DDAC1A48	48	6	1	2

Pipe Wrench

- Cast iron body
- Chrome molybdenum jaw



ITEM NO.	SIZE/LENGTH (inch)	JAW OPENING CAPACITY Ø (inch)	Satin Finished	
DDAB1A08	8	1	5	40
DDAB1A10	10	1-1/2	5	20
DDAB1A12	12	2	2	12
DDAB1A14	14	2	2	8
DDAB1A18	18	2-1/2	2	4
DDAB1A24	24	3	2	4
DDAB1A36	36	5	1	2
DDAB1A48	48	6	1	2

Pipe Wrench

(45° Swedish model pipe wrench with S-shaped jaw)

- Swedish pattern pipe wrench
- Made of drop forged Chrome Vanadium Steel
- Slim, S-shaped jaws with induction hardened teeth
- Special jaw design grips pipes at three points
- Teeth offset against direction of rotation
- Suitable for working in confined spaces

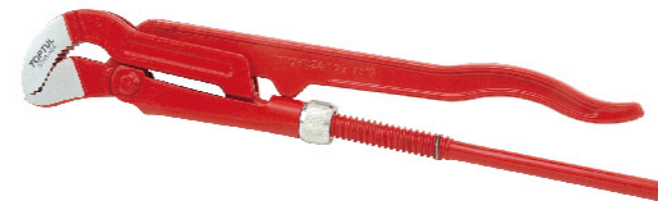

ITEM NO.	SIZE (inch)	JAW OPENING CAPACITY Ø (inch)	L (mm)	Satin Finished	
DDAD1A32	1	1-1/2	345	2	12
DDAD1A48	1-1/2	2-1/4	440	2	12
DDAD1A64	2	2-1/2	560	2	8

Adjustable Wrench

- Chrome Vanadium Steel Material
- Millimeter graduation head for quick adjustment
- Black phosphate finish
- Polished head



ITEM NO.	SIZE (inch/mm)	MAXIMUM JAW OPENING WIDTH (mm)	L (mm)	Satin Finished	
AMAC2015	6"(150mm)	20	160	10	40
AMAC2420	8"(200mm)	24	210	10	40
AMAC2925	10"(250mm)	29	260	10	40
AMAC3430	12"(300mm)	34	310	5	20
AMAC4338	15"(375mm)	43	390	2	8

Heavy Duty Adjustable Wrench

- Chrome Vanadium Steel Material
- Millimeter graduation head for quick adjustment
- Industrial-grade quality for maximum durability and corrosion resistance



ITEM NO.	SIZE (inch/mm)	MAXIMUM JAW OPENING WIDTH (mm)	L (mm)	Satin Finished	
AMAB1710	4"(100mm)	17.0	110	10	60
AMAB2415	6"(150mm)	23.9	160	10	60
AMAB2920	8"(200mm)	28.6	205	10	40
AMAB3325	10"(250mm)	32.8	255	10	30
AMAB3830	12"(300mm)	38.1	305	5	20
AMAB5038	15"(375mm)	50.0	380	2	4
AMAB6045	18"(450mm)	60.0	460	2	4

Paw Adjustable Wrench

- Chrome Vanadium Steel Material
- Millimeter graduation head for quick adjustment
- Handle weight less by 10% and over 18% wider jaw opening increase torsional rigidity and useful range of fastener sizes
- Rubber (TPR) cushion handle provides a comfortable and strong grip



ITEM NO.	SIZE (inch/mm)	MAXIMUM JAW OPENING WIDTH (mm)	L (mm)	Satin Finished	
AMAA2415	6"(150mm)	23.9	165	5	90
AMAA2920	8"(200mm)	28.6	210	5	90
AMAA3325	10"(250mm)	32.8	260	5	30
AMAA3830	12"(300mm)	38.1	310	5	30

89 **Wrenches & Torque Wrenches**

4-Way Wheel Nut Wrench

- Chrome Vanadium Steel Material
- Specially designed handle for quick removal of wheel bolts



ITEM NO.	SIZE	L(Inch)	Dual Finished	
Dual			📦	📦
AEAL1616	17 x 19 x 21mm x 1/2" Dr.	16	5	15

4-Way Wheel Nut Wrench

- Chrome Vanadium Steel Material
- Specially designed handle for quick removal of wheel bolts



• Heavy-duty forged four way wheel nut wrench. Fits most vans and trucks. 24, 27 and 32mm flange drive hexagons, and 3/4" square drive. Heat treated chrome vanadium alloy steel. Shiny Satin Finish. 22mm dia. Arm length: 700 mm.

ITEM NO.	SIZE	L(Inch)	Satin Finished	
Satin			📦	📦
AEAL2401	24 x 27 x 32mm x 3/4" Dr.	27.5	5	

Foldable Cross Rim Wrench

- Chrome Vanadium Steel Material

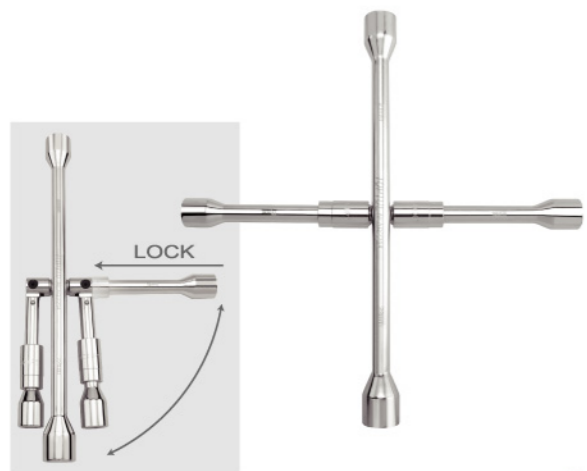

ITEM NO.	SIZE(mm)	L(Inch)	Mirror Polished	
Mirror			📦	📦
AEAQ2214	17 x 19 x 21 x 22	14	4	16



Double-End Truck Wrench W/Bar

- Chrome Vanadium Steel Material
- Wheel nut removal tools
- 6-point socket wrench



ITEM NO.	SIZE	Bar Size (Dia.x L1)	L (mm)	Satin Chrome Finished	
Satin				📦	📦
CTIA2427	24 x 27	Ø3/4"x16"	406	2	8
CTIA2730	27 x 30	Ø3/4"x16"	406	2	8
CTIA2732	27 x 32	Ø3/4"x16"	406	2	8
CTIA3032	30 x 32	Ø3/4"x16"	406	2	8
CTIA3233	32 x 33	Ø3/4"x16"	406	2	8
CTIA3238	32 x 38	Ø3/4"x16"	406	2	8

Double-End Truck Wrench W/Bar

- Chrome Vanadium Steel Material
- For off-road Budd-type wheels



ITEM NO.	SIZE	Bar Size (Dia.x L1)	L (mm)	Satin Chrome Finished	
Satin				📦	📦
CTIB3517	35 x 17 Sq.	Ø1"x16"	330	2	8
CTIB3821	38 x 21 Sq.	Ø1"x16"	430	2	8
CTIB4121	41 x 21 Sq.	Ø1"x16"	430	2	8

Ball Swivel Magnetic Spark Plug Socket T-Handle

- Chrome Vanadium Steel Material

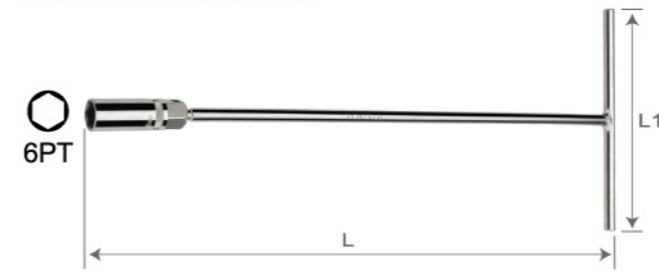

ITEM NO.	SIZE (mm)	L1 (mm)	L (mm)	Dual Finished	
Dual				📦	📦
CTHA1645	16	200	465	10	40
CTHA2145	21	200	465	10	40

Sliding T-Handle Socket Wrench



ITEM NO.	SIZE (mm)	L1 (mm)	L (mm)	Mirror Polished	
Mirror				📦	📦
CTDA0831	8	200	310	10	40
CTDA0931	9	200	310	10	40
CTDA1031	10	200	310	10	40
CTDA1131	11	200	310	10	40
CTDA1231	12	200	310	10	40
CTDA1331	13	200	310	10	40
CTDA1431	14	200	310	10	40
CTDA1731	17	200	310	10	40
CTDA1931	19	200	310	10	40

Jointed Socket Sliding T-Wrench



- Drive bar can be take out for easy storage.



- Square drive opening on the T-wrench for use with ratchets or extension tools.

ITEM NO.	SIZE (mm)	Extension Drive	L1 (mm)	L (mm)	Satin Chrome Finished	
Satin					📦	📦
CTKA0806	6	1/4"	160	400	10	40
CTKA0807	7	1/4"	160	400	10	40
CTKA0808	8	1/4"	160	400	10	40
CTKA0809	9	1/4"	160	400	10	40
CTKA1210	10	3/8"	200	450	10	40
CTKA1211	11	3/8"	200	450	10	40
CTKA1212	12	3/8"	200	450	10	40
CTKA1213	13	3/8"	200	450	10	40
CTKA1214	14	3/8"	200	450	10	40
CTKA1215	15	3/8"	200	450	10	40
CTKA1216	16	3/8"	200	450	10	40
CTKA1217	17	3/8"	200	450	10	40
CTKA1218	18	3/8"	200	450	10	40
CTKA1219	19	3/8"	200	450	10	40

Mini 3 Way T-Handle Socket Wrench

- Made of Chrome Vanadium Steel Material
- Most common sockets sizes in one compact T-type wrench
- Polished chrome finish
- 6-point socket wrench



ITEM NO.	SIZE (mm)	L1 (mm)	L (mm)	Mirror Polished	
Mirror				📦	📦
CTMA0810	8x10x12	135	145	30	90

Ball Swivel Socket Sliding T-Handle

- Chrome Vanadium Steel Material



ITEM NO.	SIZE (mm)	L1 (mm)	L (mm)	Mirror Polished	
Mirror				📦	📦
CTBA0832	8	200	320	10	40
CTBA1032	10	200	320	10	40
CTBA1132	11	200	320	10	40
CTBA1232	12	200	320	10	40
CTBA1332	13	200	320	10	40
CTBA1432	14	200	320	10	40
CTBA0860	8	200	600	10	40
CTBA1060	10	200	600	10	40
CTBA1160	11	200	600	10	40
CTBA1260	12	200	600	10	40
CTBA1360	13	200	600	10	40
CTBA1460	14	200	600	10	40

Flexible Drivers with Sliding T-Handle

- Made of Chrome Vanadium Steel Material
- Easy to use T-handle tools
- Use 1/4", 3/8" or 1/2" square drive attachments such as sockets, hex drives, crow's foot or swivels

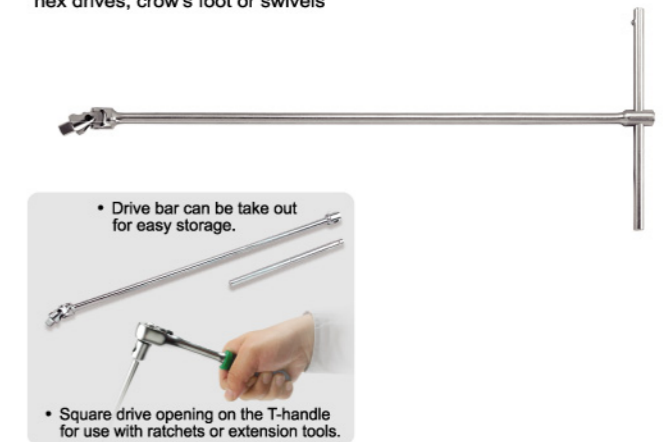

- Drive bar can be take out for easy storage.

- Square drive opening on the T-handle for use with ratchets or extension tools.

ITEM NO.	DRIVE	Extension Drive	L1 (mm)	L (mm)	Satin Chrome Finished	
Satin					📦	📦
CTLA0840	1/4"	1/4"	160	400	10	40
CTLA1245	3/8"	3/8"	200	450	10	40
CTLA1650	1/2"	1/2"	230	500	10	20

91 **Wrenches & Torque Wrenches**

Hex Nut Driver T-Handle
• Chrome Vanadium Steel Material

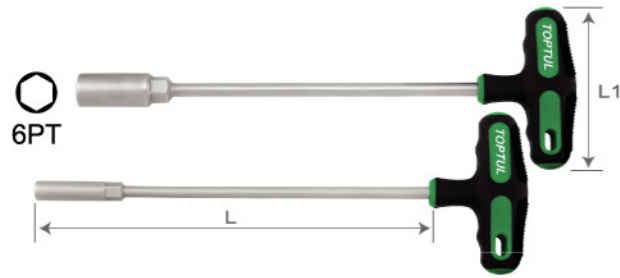

ITEM NO. Satin	SIZE(mm)	L1(mm)	L(mm)		
CTJA0523	5	95	230	5	30
CTJA0623	6	95	230	5	30
CTJA0723	7	95	230	5	30
CTJA0823	8	95	230	5	30
CTJA0923	9	95	230	5	30
CTJA1023	10	95	230	5	30
CTJA1123	11	95	230	5	30
CTJA1223	12	95	230	5	30
CTJA1323	13	95	230	5	30
CTJA1423	14	95	230	5	30

3/8" Dr. 6PT Flare Nut Crowfoot Wrench

- Made of drop forged Chrome Molybdenum Alloy Steel
- Designed to provide access to the hard to reach fasteners
- Oversized wrench surfaces grip multiple sides to reduce rounding
- Chrome plated for maximum durability and corrosion resistance
- Ideal for use on soft fittings in aluminum, copper and brass

CR-MO



ITEM NO. Satin	SIZE(mm)	L(mm)		
AEAV1210	10	36	40	400
AEAV1211	11	38	40	400
AEAV1212	12	38	40	400
AEAV1213	13	43	30	300
AEAV1214	14	43	30	300
AEAV1215	15	44	30	300
AEAV1216	16	44	30	300
AEAV1217	17	48	30	300
AEAV1218	18	48	30	300
AEAV1219	19	49	30	300

8PCS
Hex Nut Driver T-Handle Set



ITEM NO.	GZC0802		5 (SET)
CONTENTS	CTJA0723-CTJA1423 Hex Nut Driver T-Handle 7, 8, 9, 10, 11, 12, 13, 14 mm		
PLASTIC BOX: W373 x D289 x H56 (mm)			

3/8" Dr. 6PT Flare Nut Crowfoot Wrench

- Made of drop forged Chrome Molybdenum Alloy Steel
- Designed to provide access to the hard to reach fasteners
- Oversized wrench surfaces grip multiple sides to reduce rounding
- Chrome plated for maximum durability and corrosion resistance
- Ideal for use on soft fittings in aluminum, copper and brass

CR-MO



ITEM NO. Satin	SIZE(inch)	L(mm)		
AFAV1212	3/8	36	40	400
AFAV1214	7/16	38	40	400
AFAV1216	1/2	43	30	300
AFAV1218	9/16	43	30	300
AFAV1220	5/8	44	30	300
AFAV1222	11/16	48	30	300
AFAV1224	3/4	49	30	300
AFAV1228	7/8	56	20	200

10PCS
3/8" Dr. 6PT Flare Nut Crowfoot Wrench Set (METRIC)



ITEM NO.	GAAR1001	CONTENTS		10 (SET)
AEA1210-1219 10, 11, 12, 13, 14, 15, 16, 17, 18, 19 mm				

8PCS
3/8" Dr. 6PT Flare Nut Crowfoot Wrench Set (SAE)



ITEM NO.	GBAR0801	CONTENTS		10 (SET)
AFAV1212-1228 3/8", 7/16", 1/2", 9/16", 5/8", 11/16", 3/4", 7/8"				



Digital Torque Wrench

- Torque Accuracy: CW $\pm 1\%$ & CCW $\pm 1.5\%$ tolerance of the set scale value
- Precise reading accuracy for a minimum 5,000 tightening cycles
- Operating Mode: Peak hold mode (peak value detection) / Track mode (continuous display)
- Torque Unit Selection: Nm, Ft-Lb, In-Lb, Kg-m
- Storage Memory: 10 Readings
- Three way lights and buzzer when torque value is reached
- Low battery indicator and auto shut off (after 65 seconds)
- 3 Position, 32 Teeth Ratcheting Mechanism: Clockwise / Fixed / Counterclockwise
- Ergonomically designed bi-component soft grip handle
- Tested and certified according to DIN EN ISO 6789, BS EN 26789



Torque Accuracy	CW $\pm 1\%$ / CCW $\pm 1.5\%$
Storage Memory	10 Readings
Torque Unit Selection	Nm, Ft-Lb, In-Lb, Kg-m
Display Resolution	0.1 Nm, 0.1 Ft-Lb, 1 In-Lb, 0.01 Kg-m
Operating Mode	Peak Hold Mode / Track Mode
Gear Teeth	32 Precision Teeth
Ratcheting Mechanism	Clockwise / Fixed / Counterclockwise
Working Temperature	-15°C ~ 55°C
Storage Temperature	-40°C ~ 85°C
Humidity	0 ~ 90%
Battery	1.5V AA x 3pcs
Battery Life	200 Hours
Auto Shut Off	65 Seconds (when not in use)

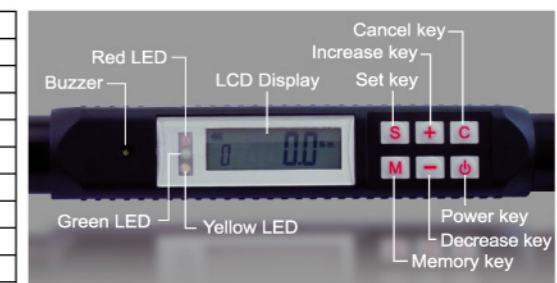

ITEM NO.	DRIVE	Torque Range			L	
		(Nm)	(Ft-Lb)	(In-Lb)	(Kg-m)	(mm)
DT-100N	3/8"	10~100	7.3~73.7	88~885	1.02~10.20	440 12
DT-200N	1/2"	20~200	14.7~147.5	176~1769	2.03~20.38	530 6

TOPTUL
YOUR BEST WORKING PARTNERS



■ **Digital Torque Adapter**

- Torque Accuracy: CW $\pm 2\%$ & CCW $\pm 2\%$ tolerance of the set scale value
- Precise reading accuracy for a minimum 5000 tightening cycles
- Operating Mode: Peak hold mode (peak value detection) / Track mode (continuous display)
- Torque Unit Selection: Nm, Ft-Lb, In-Lb, Kg-m, Kg-cm
- Storage Memory: 10 Sets
- Low battery indicator and auto shut off (after 3 minutes)
- Large LCD Display for clear reading
- Tested and certified according to DIN EN ISO 6789, BS EN 26789
- Buzzer & LED indication for pre-settable target torque.

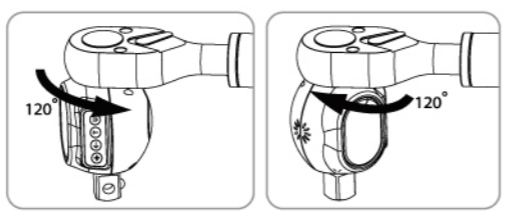

■ Rotatable mechanism design can reach total 240° view area for easily reading the torque value on the LCD display.

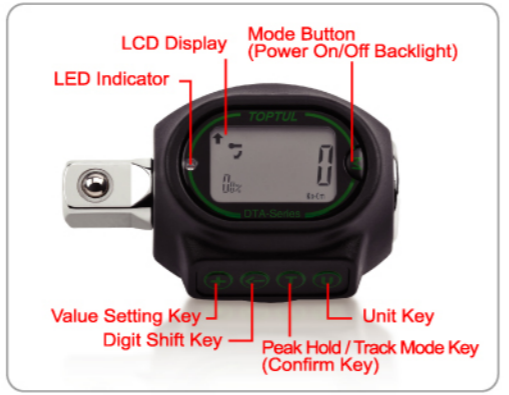

Torque Accuracy	CW $\pm 2\%$ / CCW $\pm 2\%$
Storage Memory	10 Sets
Torque Unit Selection	Nm, Ft-Lb, In-Lb, Kg-m, Kg-cm
Display Resolution	0.1 Nm, 0.1 Ft-Lb, 1 In-Lb, 0.01 Kg-m, 1Kg-cm
Operating Mode	Peak Hole Mode / Track Mode
Working Temperature	-10°C ~ 60°C
Storage Temperature	-20°C ~ 70°C
Humidity	0 ~ 90%
Battery	3V CR2032 x 1pc
Battery Life	50 Hours
Auto Shut Off	3 Minutes (when not in use)



ITEM NO.	DRIVE	(Nm)	(Ft-Lb)	Torque Range (In-Lb)	(Kg-m)	(Kg-cm)	L (mm)	⊞
DTA-200N	1/2"	40~200	29.5~147.6	354~1770	4.08~20.4	408~2040	75	48



TOPTUL
MICROMETER ADJUSTABLE
TORQUE WRENCH

■ **Micrometer Adjustable Torque Wrench (Window Display)**

- Chrome Vanadium Steel Ratchet Head
- Spring ball socket retention and push-button quick release
- Push to lock / pull to unlock scale setting feature
- Large digits for exact and easy-to-read torque setting
- Convex display simplified reading
- Ergonomically designed, Nylon material anti-slip handle
- Tolerance of torque accuracy $\pm 3\%$



Safety Locking Design



ITEM NO.	DRIVE	CAPACITY	L(mm)	⊞	48 Gears
ANAU0803	1/4"	5~25 Nm	323	6	
ANAU1210	3/8"	20~100 Nm	400	6	
ANAU1620	1/2"	40~200 Nm	517	6	



Easy Reading Screen

■ **Micrometer Adjustable Torque Wrench (Window Display)**

- Chrome Vanadium Steel Ratchet Head
- Push to lock / pull to unlock scale setting feature
- Large digits for exact and easy-to-read torque setting
- Convex display simplified reading
- Ergonomically designed, Nylon material anti-slip handle
- Tolerance of torque accuracy $\pm 3\%$



Safety Locking Design



ITEM NO.	DRIVE	CAPACITY	L(mm)	⊞	48 Gears
ANAU2475	3/4"	150~750 Nm	1210	1	
ANAU32A0	1"	200~1000 Nm	1500	1	



Easy Reading Screen

95 Wrenches & Torque Wrenches

- Micro Adjustable Torque Wrench**
- Chrome Vanadium Steel Ratchet Head
 - 3-Way Ratchet Drive Mechanism: Forward / Lock / Reverse
 - Quick release button ensures firm socket retention and easy socket removal
 - Easy torque adjustment, positive lock with spring loaded pull-down lock ring
 - Applied to test torque clockwise and counterclockwise direction
 - Comfortable ergonomic handle
 - Tolerance of torque accuracy $\pm 4\%$ CW and $\pm 6\%$ CCW



ITEM NO.	DRIVE	CAPACITY	L(mm)	32 Gears
ANAS0803	1/4"	6-30Nm	260	20
ANAS1211	3/8"	20-110Nm	435	10
ANAS1621	1/2"	40-210Nm	495	10
ANAS1635	1/2"	70-350Nm	560	6

- Micro Adjustable Torque Wrench**
- Chrome Vanadium Steel Ratchet Head
 - 3-Way Ratchet Drive Mechanism: Forward / Lock / Reverse
 - Easy torque adjustment, positive lock with spring loaded pull-down lock ring
 - Applied to test torque clockwise and counterclockwise direction
 - Comfortable ergonomic handle
 - Tolerance of torque accuracy $\pm 4\%$ CW and $\pm 6\%$ CCW



ITEM NO.	DRIVE	CAPACITY	L(mm)	36 Gears
ANAS2480	3/4"	100-800Nm	1000	1

- Torque Wrench**
- CR-V/CR-MO Steel Ratchet Head
 - Equip flip reverse ratchet action function
 - Unique push to lock/pull to unlock scale setting feature
 - Ergonomically designed, TPR material anti-slip handle
 - Tolerance of torque accuracy $\pm 4\%$



ITEM NO.	DRIVE	CAPACITY	L(mm)	24 Gears
ANAG0825	1/4"	40-250in-LB	350	12
ANAG1225	3/8"	40-250in-LB	350	12
ANAG1208	3/8"	15-80Ft-LB	385	12
ANAG1615	1/2"	30-150Ft-LB	535	10
ANAG1625	1/2"	50-250Ft-LB	645	6
ANAG2430	3/4"	50-300Ft-LB	865	4

- Torque Wrench**
- CR-V/CR-MO Steel Ratchet Head
 - Equip flip reverse ratchet action function
 - Unique push to lock/pull to unlock scale setting feature
 - Ergonomically designed, TPR material anti-slip handle
 - Tolerance of torque accuracy $\pm 4\%$



ITEM NO.	DRIVE	CAPACITY	L(mm)	24 Gears
ANAF0803	1/4"	6-30Nm	350	20
ANAF1203	3/8"	6-30Nm	350	20
ANAF1211	3/8"	20-110Nm	385	12
ANAF1621	1/2"	40-210Nm	535	10
ANAF1635	1/2"	70-350Nm	645	6
ANAF2450	3/4"	100-500Nm	865	4

- Torque Wrench**
- CR-MO Steel Ratchet Head
 - Equip flip reverse ratchet action function
 - Unique push to lock/pull to unlock scale setting feature
 - Tolerance of torque accuracy $\pm 4\%$



• Torque Wrench
- ANAA2470 (140-700Nm)



• Torque Wrench
- ANAB2460 (100-600Ft-LB)

ITEM NO.	DRIVE	CAPACITY	L(mm)	24 Gears
ANAA2470	3/4"	140-700Nm	1092	4
ANAA2498	3/4"	140-980Nm	1230	2
ANAA3298	1"	140-980Nm	1230	2

- 11PCS**
1/2" DR. Torque Wrench Set



ITEM NO.	CONTENTS	6 (SET)
GAAI1102	1 ANAF1621 1/2" Dr. Torque Wrench (40-210Nm)	
	• BAEA1617-1627 1/2" Dr. 6PT Flank Sockets 17, 19, 21, 22, 24, 27 mm	
	• BCDA1606-1612 1/2" Dr. Hex Bit Sockets 6, 8, 10, 12 mm	

BLOW CASE: W588 x D80 x H74 (mm)

- Torque Wrench**
- CR-MO Steel Ratchet Head
 - Equip flip reverse ratchet action function
 - Unique push to lock/pull to unlock scale setting feature
 - Tolerance of torque accuracy $\pm 4\%$



TOPTUL
MICRO ADJUSTABLE TORQUE WRENCH



TOPTUL
TORQUE WRENCHES SERIES

■ **Micrometer Adjustable Torque Wrench (Window Display)**

- Chrome Vanadium Steel Ratchet Head
- Flip reverse ratchet action
- Spring ball socket retention and push-button quick release
- Push to lock / pull to unlock scale setting feature
- Large digits for exact and easy-to-read torque setting
- Convex display simplifies reading
- Ergonomically designed, Nylon material anti-slip handle
- Tolerance of torque accuracy $\pm 3\%$



ITEM NO.	DRIVE	CAPACITY	L(mm)	45 Gears
ANAM0803	1/4"	1-25Nm	290	10
ANAM1205	3/8"	5-50Nm	360	10
ANAM1610	1/2"	10-100Nm	405	10
ANAM1620	1/2"	20-200Nm	500	10
ANAM1630	1/2"	60-300Nm	595	10
ANAM1640	1/2"	80-400Nm	680	8

■ **Interchangeable Torque Handle**



ITEM NO.	HEAD SIZE	CAPACITY	L(mm)
ANAH0303	9x12	6-30Nm	280
ANAH0108	14x18	10-80Nm	360
ANAH0121	14x18	40-210Nm	509

■ **Interchangeable Torque Handle (Window Display)**



ITEM NO.	HEAD SIZE	CAPACITY	L(mm)
ANAJ0130	14x18	60-300Nm	575

■ **Ratchet Head**

- CR-MO Steel Ratchet Head
- 24 teeth



ITEM NO.	HEAD SIZE	DRIVE	L(mm)
ANAL0412	9x12	3/8"	56
ANAL0216	14x18	1/2"	78
ANAL0116	14x18	1/2"	94

■ **Spanner Head**

- CR-V Steel Head



ITEM NO.	HEAD SIZE	SIZE(mm)	L(mm)
ANAR0307	9x12	7	42
ANAR0308	9x12	8	42
ANAR0309	9x12	9	44
ANAR0310	9x12	10	45
ANAR0311	9x12	11	45
ANAR0312	9x12	12	46
ANAR0313	9x12	13	49
ANAR0314	9x12	14	50
ANAR0113	14x18	13	70
ANAR0114	14x18	14	70
ANAR0115	14x18	15	70
ANAR0116	14x18	16	73
ANAR0117	14x18	17	73
ANAR0119	14x18	19	75
ANAR0122	14x18	22	77
ANAR0124	14x18	24	78
ANAR0126	14x18	26	78
ANAR0127	14x18	27	82
ANAR0129	14x18	29	85
ANAR0130	14x18	30	87
ANAR0132	14x18	32	87

■ **Spanner Head**

- CR-V Steel Head



ITEM NO.	HEAD SIZE	SIZE(mm)	L(mm)
ANAK0307	9x12	7	37
ANAK0308	9x12	8	37
ANAK0309	9x12	9	38
ANAK0310	9x12	10	39
ANAK0311	9x12	11	39
ANAK0312	9x12	12	40
ANAK0313	9x12	13	42
ANAK0314	9x12	14	42
ANAK0113	14x18	13	63
ANAK0114	14x18	14	63
ANAK0115	14x18	15	64
ANAK0116	14x18	16	64
ANAK0117	14x18	17	64
ANAK0119	14x18	19	65
ANAK0122	14x18	22	66
ANAK0124	14x18	24	67
ANAK0126	14x18	26	70
ANAK0127	14x18	27	70
ANAK0129	14x18	29	74
ANAK0130	14x18	30	74
ANAK0132	14x18	32	77

99 Wrenches & Torque Wrenches



TOPTUL
TORQUE WRENCHES SERIES

8PCS
1/2" DR. Head-Interchangeable Spanner Torque Wrench Set



ITEM NO.	CONTENTS	6 (SET)
GAAI0801	1 ANAH0108 14x18 Head Size Interchangeable Torque Handle (10-80Nm)	
	1 ANAL0216 1/2" Dr. Ratchet Head	
	6 ANAK0117-0129 Spanner Head 17, 22, 24, 26, 27, 29 mm	

BLOW CASE: W420 x D210 x H55 (mm)

10PCS
3/8" DR. Head-Interchangeable Spanner Torque Wrench Set



ITEM NO.	CONTENTS	10 (SET)
GAAI1001	1 ANAH0303 9x12 Head Size Interchangeable Torque Handle (6-30Nm)	
	1 ANAL0412 3/8" Dr. Ratchet Head	
	8 ANAK0307-0314 Spanner Head 7, 8, 9, 10, 11, 12, 13, 14 mm	

BLOW CASE: W360 x D140 x H64 (mm)

11PCS
1/2" DR. Head-Interchangeable Spanner Torque Wrench Set



ITEM NO.	CONTENTS	4 (SET)
GAAI1101	1 ANAH0121 14x18 Head Size Interchangeable Torque Handle (40-210Nm)	
	1 ANAL0116 1/2" Dr. Ratchet Head	
	9 ANAK0113-0130 Spanner Head 13, 14, 15, 17, 19, 22, 24, 27, 30 mm	

BLOW CASE: W545 x D146 x H55 (mm)

1/2" DR. Torque Wrench
• This torque wrench is accurate to ±4% of the set load and has been manufactured and tested in accordance with DIN3122 & ISO 6789.

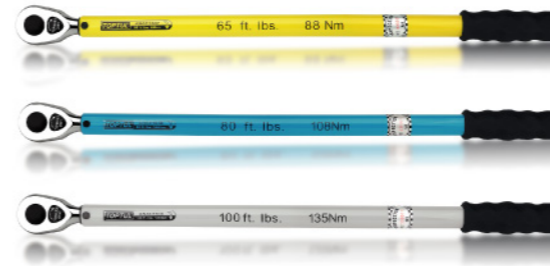

ITEM NO.	CAPACITY	L(mm)	32 Gears
ANAC1607	65Ft-LB/88 Nm	578	12
ANAC1608	80Ft-LB/108 Nm	578	12
ANAC1610	100Ft-LB/135 Nm	578	12



ITEM NO.	CAPACITY	L(mm)	32 Gears
ANAC1612	120Ft-LB/163 Nm	578	12
ANAC1614	140Ft-LB/190 Nm	578	12

2PCS
1/4" Hex Drive Torque Screwdriver Set
• Reduced weight and size specifically designed for low torque application
• Clockwise operation device
• Easy to read window scale
• 1/4" female hexagon drive for use with 1/4" hexagon bits
• Ease of use, additional 1/4" female square drive on the handle accommodates T-handle, ratchet handle and etc.
• Micrometer scale graduation: 0.1 Nm
• Actuation accuracy: ±6% tolerance of the set scale value
• Test certificate in accordance with DIN EN ISO 6789 national standard



ITEM NO.	CONTENTS	30 (SET)
GCAI0202	1 ANBD0808 1/4" Hex Drive Torque Screwdriver 1.5-8 Nm (L=162mm)	
	1 CTCK0811 1/4" Dr. Sliding T-Handle (L=115mm)	

BLOW CASE: W200 x D68 x H57 (mm)

2PCS
1/4" DR. Torque Screwdriver Set
• Easy to read window scale
• Clockwise operation device
• 1/4" square driver head for sockets, bit holders and accessories
• Micrometer scale graduation: 0.5 Nm
• Actuation accuracy: ±6% tolerance of the set scale value
• Test certificate in accordance with DIN EN ISO 6789 national standard



ITEM NO.	CONTENTS	30 (SET)
GCAI0201	1 ANAD0808 1/4" Dr. Torque Screwdriver 1-8 Nm (L=153mm)	
	1 FTAB0808 1/4" Dr. x 1/4" (H) Quick Change Bit Holder (L=25mm)	

BLOW CASE: W200 x D68 x H57 (mm)

Professional Grade
Torque Tester (Calibrator)

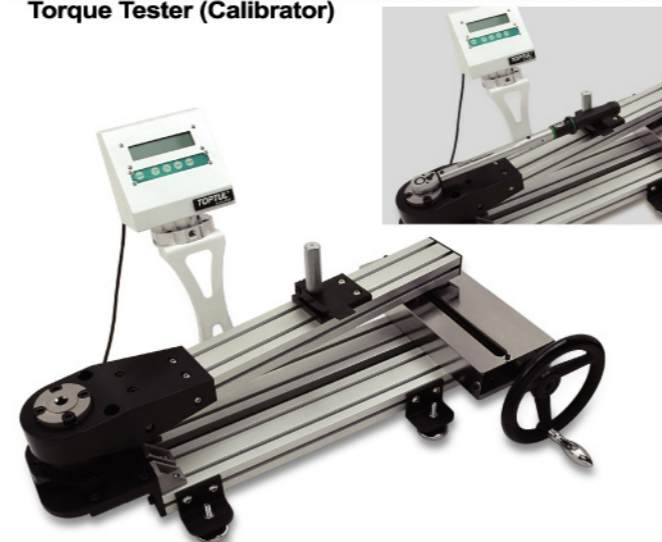

ITEM NO.	IEA040400
TECHNICAL SPECIFICATION	
Calibration Range	40-400 Nm
Display	5 alphanumeric digits max.
Accuracy	±0.5%
Units of Measurement	Nm, Ft-Lb, In-Lb, Kg-cm
Operating Temperature	+5°C~+40°C
Storage Temperature	0°C~+50°C
Operating Humidity	25-85 % RH
Power Supply	90-260 V.A.C. at 50/60 Hz.
Power Consumption	Less than 1.5 Watt
Power Cable	1.8 Meter
Base Material	Anodized Aluminum Alloy
Dimension	850(L)x650(W)x450(H) mm
PC Connection	RS 232
Net Weight	38.2Kg

(*Includes 3 Test Drive Adapter: 3/8", 1/2" & 3/4" S.Q. Drive)



101 **Wrenches & Torque Wrenches**

Torque Multiplier
• Chrome-Molybdenum Steel

DIN3122



TOPTUL
YOUR BEST WORKING PARTNERS

ITEM NO.	SIZE (CAPACITY)	🔧	📦
ANAE1624	1/2"(F)x3/4"(M) INPUT(MAX): 500Nm/365Ft-LB OUTPUT(MAX): 1500Nm/1100Ft-LB	1	4
ANAE2432	3/4"(F)x1"(M) INPUT(MAX): 1000Nm/730Ft-LB OUTPUT(MAX): 3000Nm/2200Ft-LB	1	4

5PCS

- Torque Multiplier Set
• Torque Multiplier is made of Chrome Molybdenum Alloy Steel
• High-efficiency planetary gear sets achieve high output torque from low input torque
• Gear Ratio - 1:9 Torque Ratio - 1:6.5
• Supplied with two reaction arm styles for maximum versatility
• Additional safety break-away adapter to prevent direct damages to multiplier in case of overload



- Safety Break-Away Adapter will protect and prevent the torque multiplier from damages caused by an overload.

ITEM NO.	CONTENTS	🔧	📦
ANBE1624	1 Torque Multiplier 1/2" (F) x 3/4" (M) Input (Max.): 231Nm / 170Ft-Lb Output (Max.): 1500Nm / 1105Ft-Lb 1 Reaction Arm 1 Safety Break-Away Adapter 1 90° Reaction Arm 1 90° Reaction Base	2	(SET)

BLOW CASE: W400 x D260 x H110 (mm)

5PCS

- Torque Multiplier Set
• Gear Ratio - 1:12 Torque Ratio - 1:9



5PCS

- Torque Multiplier Set
• Gear Ratio - 1:4 Torque Ratio - 1:3.3



ITEM NO.	CONTENTS	🔧	📦
ANBE1632	1 Torque Multiplier 1/2" (F) x 1" (M) Input (Max.): 222Nm / 164Ft-Lb Output (Max.): 2000Nm / 1475Ft-Lb 1 Reaction Arm 1 Safety Break-Away Adapter 1 90° Reaction Arm 1 90° Reaction Base	2	(SET)

BLOW CASE: W400 x D260 x H110 (mm)

ITEM NO.	CONTENTS	🔧	📦
ANBE2432	1 Torque Multiplier 3/4" (F) x 1" (M) Input (Max.): 758Nm / 560Ft-Lb Output (Max.): 2500Nm / 1845Ft-Lb 1 Reaction Arm 1 Safety Break-Away Adapter 1 90° Reaction Arm 1 90° Reaction Base	2	(SET)

BLOW CASE: W400 x D260 x H110 (mm)

Hand Sockets, Bit Sockets & Accessories Series
Full

range of flank sockets with maxi-drive. Available in 1/4", 3/8", 1/2", 3/4" & 1".

www.toptul.com

102

HAND SOCKETS, BIT SOCKETS & ACCESSORIES SERIES



PROFESSIONAL HAND TOOLS

HAND SOCKETS, BIT SOCKETS & ACCESSORIES