

最高級  
六角棒スパナ



*Excellent*

**HEXAGON WRENCH**

**Vol.69 2015.04**



**EXPORT**

# THE BEST QUALITY APPROVED BY WORLD USERS.

**EIGHT** Hexagon wrenches are sold and used in many countries around the world, earning a reputation as a top brand for their high quality.

**EIGHT** is the only company in the world specializing in production of Hexagon wrenches, whose high quality of durability are above competition.



EXCELLENT HEXAGON WRENCH

## PRODUCTION AND SUPPLY : RELIABLE SUPERIOR PRODUCTS

Since our origin, we have been producing **SUPERIOR PRODUCTS** under our quality-conscious production system to satisfy the strict requirement of professional users. For more positive expansion in 21st century, we intend to develop new quality products to meet the various demands of the new age and to provide a stable supply for world-wide markets.

## RELIABLE QUALITY BORNE FROM ORIGINAL TECHNOLOGY

### CONSISTENT PRODUCTION SYSTEM AND QUALITY CONTROL

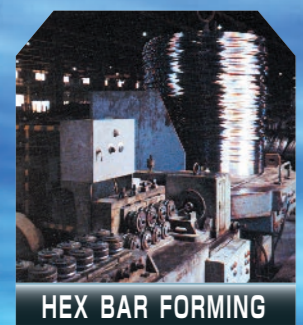

HEX BAR FORMING

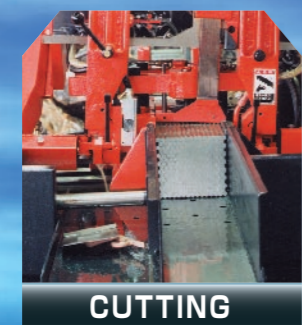

CUTTING



CHAMFERING



MACHINING



BENDING AND STAMPING



HEAT TREATMENT



SURFACE TREATMENT



INSPECTION

# NEW PRODUCTS



COLOR HEXAGON WRENCH  
EXTRA LONG LENGTH



WITH EXTENSION PIPE  
EXTRA LONG LENGTH



# NEW PRODUCTS

BOREHOLE DOUBLE END  
HEXAGON WRENCH  
STANDARD LENGTH



CROSS TYPE WRENCH



ROCKET TYPE SCREWDRIVER  
FREE COMBINATION



T TYPE HEXAGON WRENCH  
SEPARABLE HANDLE

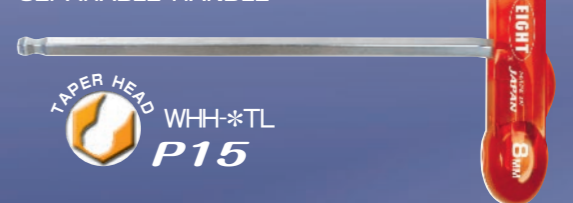

NEW FLAG TYPE  
PRECISION SCREWDRIVER



T TYPE HEXAGON WRENCH  
SHORT LENGTH



"TX" FLAG TYPE WRENCH



0.71~10mm Set  
STANDARD LENGTH 0.71~10mm 12 Pcs.  
STANDARD LENGTH 0.71~3mm 7 Pcs.



"TX" L TYPE WRENCH



1/2" "TX" SOCKET BIT  
STANDARD LENGTH













1/2" & 3/8" HEXAGON SOCKET BIT  
STANDARD LENGTH & 110mm OVERALL LENGTH



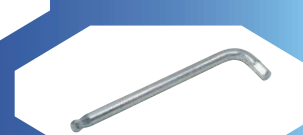

## EXCELLENT SERIES

10~

	<b>TAPER HEAD HEXAGON WRENCH</b> TLS / TL / TEL / TMS / TM / TS / T / WP (PIPE)	13~17 26~28
	<b>BALL POINT HEXAGON WRENCH</b> BHS / BH / WP (PIPE)	21~23
	<b>HEXAGON WRENCH</b> LHS / LH / RS / R / WP (PIPE)	24~25 29
	<b>TAPER HEAD BOLT CATCH HEXAGON WRENCH</b> BCT	18
	<b>TAPER HEAD &amp; BALL POINT COLOR HEXAGON WRENCH</b> TLC / BHC	12 21
	<b>TAPER HEAD SPECIAL SHORT ARM HEXAGON WRENCH</b> TTS / TT / TTR	19~20
	<b>TAPER HEAD COLOR DIPPED HEXAGON WRENCH</b> TLLB	30
	<b>TAPER HEAD STAINLESS HEXAGON WRENCH</b> VS	31
	<b>HEXAGON SCREWDRIVER</b> TD / DS / D	32~33
	<b>T TYPE HEXAGON WRENCH STEEL HANDLE</b> BCTT500 / BCTT / STT500 / STT / ST500 / ST	34~36
	<b>T TYPE HEXAGON WRENCH PLASTIC HANDLE</b> EXS / EXH / EXT / WHH	15 37







## SOCKET BIT / BIT

38~

	<b>HEXAGON SOCKET BIT</b> EXCELLENT SERIES 21TB, LB, SB / 21HB / 83TB, LB, SB / 41SB	38~43
	<b>HEXAGON SOCKET BIT</b> STANDARD SERIES 21LB-B, SB-B / 83LB-B, SB-B	68~69
	<b>HEXAGON BIT / CROSS POINT SCREWDRIVER BIT</b> EA-61~70 / EA-01~06	44~47 70~73

## STANDARD SERIES







48~

	<b>HEXAGON WRENCH</b> 001 / 001H / 002 / 004 / 008 / 012 / 013 / 014 / ET / M	50~57
	<b>TAPER HEAD HEXAGON WRENCH</b> TA14	67
	<b>BALL POINT HEXAGON WRENCH</b> 016	58~59
	<b>KNIFE &amp; CROSS TYPE HEXAGON WRENCH</b> NHT / NHP / 009 / SYU <small>CROSS TYPE</small>	60~61
	<b>HEXAGON SCREWDRIVER</b> BDS / BD / 006 / RR-S6 / HFD <small>FLAG TYPE</small>	62~63
	<b>T TYPE HEXAGON WRENCH PLASTIC HANDLE</b> 018L / 018S / 018 / PTT / PTH	64~66

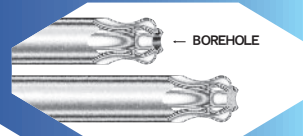
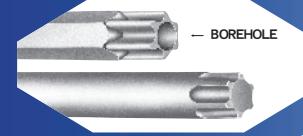
## "TX" SERIES

for Hexalobular

74~

	<b>BALL POINT "TX" WRENCH "BOREHOLE &amp; NORMAL"</b> TXBH / TXB <small>BOREHOLE</small>	88~89
	<b>"TX" WRENCH "BOREHOLE &amp; NORMAL"</b> TXH / TXL / TX / IT <small>BOREHOLE</small>	77~78
	<b>KNIFE TYPE "TX" WRENCH</b> TXN	79
	<b>"TX" SCREWDRIVER "BOREHOLE &amp; NORMAL"</b> TXDH / NTDH / TXD / XFD <small>BOREHOLE BOREHOLE FLAG TYPE</small>	80~83
	<b>T, FLAG &amp; WING TYPE "TX" WRENCH</b> XT / XF / XW	84~85
	<b>"TX" BIT WITH BIT HOLDER &amp; SOCKET BIT</b> 21XBL / 21XB / 21XSB / 83XSB	86~87
	<b>"TX" E-TYPE SOCKET</b> 21XE	87
	<b>"TX" BIT "BOREHOLE &amp; NORMAL"</b> EA-33 / EA-34 <small>BOREHOLE</small>	76

## DATA

91~

CUSTOM-MADE PRODUCTS / CONFORMITY CHART OF SCREW  
CONVERSION CHART / ABOUT TORQUE / ALPHABETICAL INDEX

92~101

⚠ Production and sale of products similar to our original logotype, design, function etc. are prohibited. We will appeal for legal actions if similar products are found.  
⚠ 嚴禁製造與販賣類似於本公司商標、產品設計與功能的仿造品。如經發現，本公司將付諸法律手段。

Easy access to the required product by shape.

L type	Super long length	Extra long length	Long length	Standard length
<b>TAPER HEAD</b> 	 P30 (Color dipped)	 P12 (Color Wrench) P13 (With Pipe) P14, 15, 16, 17 P67	 P26, 27	 P28
<b>SPECIAL SHORT ARM STAINLESS</b> 			 P31	
<b>BOLT CATCH</b> 		 P19		 P20
<b>BALL POINT</b> 		 P21 (Color Wrench) P21 (With Pipe) P22, 23	 P58, 59	
<b>HEX</b> 		 P24, 25 P24 (With Pipe) P56, 57	 P54, 55	 P29 P50, 51 52, 53, 54
<b>HEX (BOREHOLE)</b> 			 P51 Borehole on both ends	
<b>TX</b> 			 P78 Borehole	 P78
<b>TX (BOREHOLE)</b> 			 P77 Borehole	
<b>TX BALL POINT</b> 			 P89	
<b>TX BALL POINT (BOREHOLE)</b> 			 P88 Borehole on both ends	

KNIFE type	Plastic cover type	Metal case type
<b>HEX</b> 	 P60 P61	 P60
<b>TX</b> 	 P79	 P79

DRIVER type	Solid type	Interchangeable type
<b>TAPER HEAD</b> 	 P32	
<b>BALL POINT</b> 	 P62	
<b>HEX</b> 	 P33 P63	 P63
<b>TX</b> 	 P82	 P83
<b>TX (BOREHOLE)</b> 	 P80 P81 Borehole	
<b>CROSS POINT</b> 		 P37 ※ Accessories

● Pages in **Red** color for Excellent series, **Blue** color for Standard series.  
● See the indicated page for details.

T type	Plastic Handle	Steel Handle
<b>TAPER HEAD</b> 	 P66 P37 P15 (Separation type) P61 (Cross type)	 P35 Standard & Long length
<b>BOLT CATCH</b> 		 P34 Standard & Long length
<b>HEX</b> 	 P66 P37 P64 P65	 P36 Standard & Long length
<b>TX</b> 	 P84 P85 (Flag type) P85 (Wing type)	

SOCKET BIT type	Square drive 6.35mm(1/4")	Square drive 9.5mm(3/8")	Square drive 12.7mm(1/2")
<b>TAPER HEAD</b> 		 P40 130	 P38 130
<b>HEX</b> 	 P43 Standard length	 P41 P69 110 Standard length	 P39 P68 P42 110 Standard length
<b>TX</b> 		 P87 Standard length	 P86 P87 Standard length
<b>SQUARE (HANDLE)</b> 	 P43 (With Bit Holder)	 P43	
<b>SOCKET (BIT HOLDER)</b> 	 P43 6.35	 P42, 86 9.5	 P42, 86 12.7
<b>SOCKET (TX E-type)</b> 			 P87 12.7

BIT type	Shank : 5mm hex	Shank : 6.35mm(1/4") hex	Shank : 8mm hex
<b>TAPER HEAD</b> 	 P46 13	 P44 L9 13	 P46 13
<b>HEX</b> 	 P47 13	 P45 L9 13	 P47 13
<b>TX</b> 		 P76 L9 13	 P86
<b>TX (BOREHOLE)</b> 		 P76 Borehole L9 13	
<b>CROSS POINT</b> 	 P72 16 L13	 P70 P71 17 L13 12 L9	 P72 20 L13
		 P71 L9	 P73

EXCELLENT SERIES

STANDARD SERIES

TX SERIES

L type

KNIFE type

SCREW DRIVER type

T type

SOCKET BIT type

BIT type

Our company is the only specialized high-quality Hexagon wrenches manufacturer in Japan.

All products are produced under stringent quality production system.



## EXCELLENT SERIES

### ●MATERIAL:

Special Version of **SNCM+V®** alloy steel. Specially developed for "EIGHT" Hexagon Wrenches and characterized by tougher resistance against abrasion and high torque to achieve the best quality in the world.

### ●HARDNESS:

Rockwell "C" Scale 55~60 degree hardness standard exceeds any other to provide high torsional strength and durability in addition to exceptional toughness.

### ●ACCURACY:

Held at the most strict standard for the accurate shaping of flats and corners to enable precise fitting to fasteners' holes, and to achieve a remarkable resistance against abrasion.

### ●SURFACE FINISH

Chamfered ends permit easy fitting to fasteners' holes and allow for an excellent grip.

### ●HARD-CHROME PLATING:

The best plating for Hexagon wrenches is applied to keep strict accuracy, powerful rust resistance and beautiful appearance.

## 卓越系列

### 材質

#### SNCM+V® 特殊合金鋼

爲了實現世界最高的產品質量，本公司獨自開發出具有高度耐磨性以及出色扭力的特殊合金鋼。本公司不斷追求更為強韌的鋼材，對產品進行更新換代，以適應更為苛刻的使用環境。

### 硬度

#### H<sub>R</sub>C 55~60

專業的熱處理技術，使材質的優良性得以最大的發揮。本公司成功的在高水平上調整了硬度與韌性的平衡。通過具有出色再現性的熱處理技術，抑制了受熱不均勻以及脫碳的狀況。硬度超過了世界各國的標準。

### 精度

對於內六角扳手的對邊、對角的精確度，本公司設定了一套對誤差極為嚴格的公司內部標準。超過了 JIS 標準（日本工業規格標準）。對鑽石頭，球頭等的加工精確度，也同樣制定內部標準，加以嚴格的工序管理。因此，本公司的扳手可與螺絲孔嚴密扣合，充分發揮耐磨性。

### 表面處理

斷面加工 . . . . . 使扳手更易滑入螺絲孔，手感光滑。  
硬鍍鍍金 . . . . . 堅硬美觀，不易生鏽。



**EX = EXCELLENT SERIES**



## EXCELLENT SERIES Hexagon Wrenches

are well received by domestic and foreign professional users in the world.

L type



SCREW DRIVER type



T type



SOCKET BIT type



BIT type

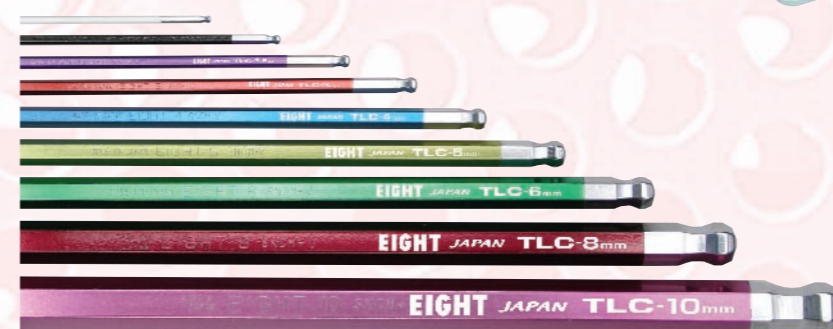

**ALL NEW "TAPER HEAD" HEXAGON WRENCH** COLOR WRENCH SILK SCREEN PRINTED

EXTRA LONG LENGTH

**TLC-S9N** DOUBLE DECKER TYPE HOLDER SET ■ SNCM+V® special ■ Hard chrome plated

**COLOR HEXAGON WRENCH**



**EASY ACCESS AT A GLANCE ! COLORS STANDING FOR SIZES**

● Colors of high durable baking finish standing for sizes respectively and silk screen printing of sizes applied to 2.5-10 mm.

Metric size (Slide blister pack)

Item No.	Pcs.	H									Inner	W x H x D	g
TLC-S9N	9	1.5	2	2.5	3	4	5	6	8	10	5	305x100x110	2,436

Specific production for same color set is available.



"TAPER HEAD"

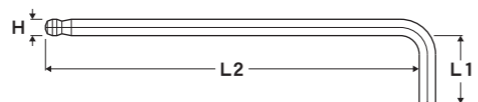

**TLC-\* INDIVIDUAL**

Metric size (Poly bag with header)

Item No.	H	L1	L2	Inner	W x H x D	g
TLC-1.5	1.5	16	79	10	165x70x33	51
TLC-2	2	17	95	10	165x70x33	68
TLC-2.5	2.5	18	110	10	165x70x33	90
TLC-3	3	20	126	10	204x67x30	137
TLC-4	4	25	142	10	228x67x30	235
TLC-5	5	28	160	10	250x74x30	241
TLC-6	6	32	180	10	252x90x31	576
TLC-8*	8	36	200	10	252x90x31	1,083
TLC-10*	10	40	224	10	252x90x31	1,841

※Bulk pack for TLC-8 and TLC-10

**ALL NEW "TAPER HEAD" HEXAGON WRENCH** WITH EXTENSION PIPE

EXTRA LONG LENGTH

**TLS-9NP** DOUBLE DECKER TYPE HOLDER SET WITH EXTENSION PIPES ■ SNCM+V® special ■ Hard chrome plated

**WITH EXTENSION PIPES 2pcs.**



Two-way extension pipes offer high torque transmission.



Metric size with pipes (Slide blister pack)

Item No.	Pcs.	H										Inner	W x H x D	g
TLS-9NP	9	1.5	2	2.5	3	4	5	6	8	10	& PIPES	5	307x105x125	3,129

To Remove The Pipes

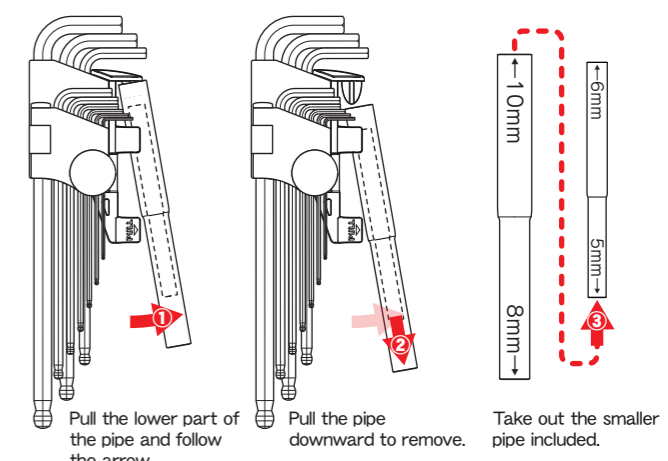

\* To store the pipes, reverse the instructions above.

**WP-S2 EXTENSION PIPES SET**

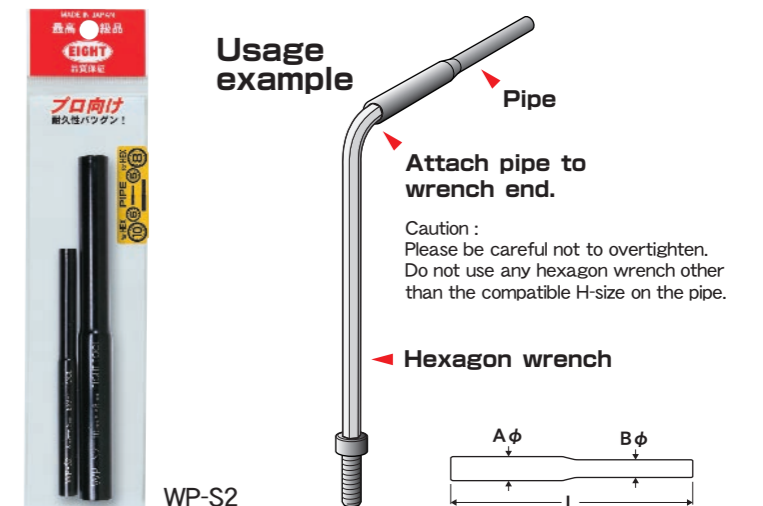

Extension pipes (Poly bag with header)

Item No.	Pcs.	Pipe size against wrench (H)	L	Aφ	Bφ	Inner	W x H x D	g
WP-S2	2	Pipe L : 8 ⇔ 10 mm Pipe S : 5 ⇔ 6 mm	150 110	15.9 9.5	13.8 8.0	10	245x93x68	1,312

EXCELLENT SERIES  
STANDARD SERIES  
TX SERIES  
L type  
KNIFE type  
SCREW DRIVER type  
T type  
SOCKET BIT type  
BIT type

EXCELLENT SERIES  
STANDARD SERIES  
TX SERIES  
L type  
KNIFE type  
SCREW DRIVER type  
T type  
SOCKET BIT type  
BIT type

# "TAPER HEAD" HEXAGON WRENCH

EXTRA LONG LENGTH

## TLS-9N DOUBLE DECKER TYPE HOLDER SET

■ SNCM+V® special ■ Hard chrome plated

Metric size (Slide blister pack)

Item No.	Pcs.	H								Inner	W x H x D	g	
TLS-9N	9	1.5	2	2.5	3	4	5	6	8	10	5	305x100x110	2,431

- Front folder rises up for easy removed and storage.
- Front and back folders can be separated by pulling out the linkage pin.

## TL / TEL-\* INDIVIDUAL

Metric size (Slide blister pack)

Item No.	H	L1	L2	Inner	W x H x D	g
TL-1.5	1.5	16	79	10	170x68x50	124
TL-2	2	17	95	10	170x68x50	138
TL-2.5	2.5	18	110	10	170x68x50	168
TL-3	3	20	126	10	200x70x60	223
TL-4	4	25	142	10	200x70x60	314
TL-5	5	28	160	10	240x90x68	533
TL-6	6	32	180	10	240x90x68	721
TL-8	8	36	200	5	285x90x58	688
TL-10	10	40	224	5	285x90x58	1,068
TL-11	11 (7/16")	43	240	4	355x105x65	1,193
TL-12	12	45	250	4	355x105x65	1,396
TL-14	14	55	280	4	355x105x65	2,020
TL-17*	17	60	320	4	347x100x40	3,046
TL-19*	19 (3/4")	70	360	4	410x95x45	4,294

※Bulk pack for TL-17 and TL-19

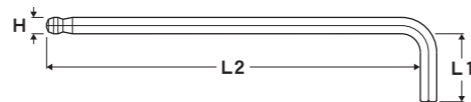

Inch size (Slide blister pack)

Item No.	H	L1	L2	Inner	W x H x D	g
TEL-1/16	1/16"	15	79	10	170x68x50	128
TEL-5/64	5/64"	17	93	10	170x68x50	139
TEL-3/32	3/32"	18	108	10	170x68x50	161
TEL-1/8	1/8"	20	127	10	200x70x58	238
TEL-5/32	5/32"	25	140	10	200x70x58	312
TEL-3/16	3/16"	28	158	10	240x93x68	497
TEL-1/4	1/4"	32	178	10	240x93x68	777
TEL-5/16	5/16"	36	198	5	285x140x85	676
TEL-3/8	3/8"	40	222	5	285x140x85	981
TL-7/16	7/16"	43	240	4	355x105x65	1,193
TL-1/2	1/2"	45	248	4	355x105x65	1,525
TL-9/16*	9/16"	55	278	4	300x90x33	1,887
TL-5/8*	5/8"	60	320	4	347x100x40	2,670
TL-3/4*	3/4"	70	360	4	410x95x45	4,294

※Draw your attention to the difference between TEL and TL when you order.

※Bulk pack for the sizes from 9/16 to 3/4 inch.



TL-10

TL-6

TL-4

# "TAPER HEAD" HEXAGON WRENCH

EXTRA LONG LENGTH

## WHH-\*TL INDIVIDUAL WITH SEPARABLE HANDLE

■ SNCM+V® special ■ Hard chrome plated

Metric size (Hanging header)

Item No.	H	L1	L2	Overall length	Inner	W x H x D	g
WHH-3TL	3	69	116	138	10	205x95x71	375
WHH-4TL	4	69	134	156	10	225x110x77	508
WHH-5TL	5	69	154	176	10	290x135x85	676
WHH-6TL	6	87	167	196	10	290x135x85	1,123
WHH-8TL	8	87	190	219	10	322x178x70	1,605
WHH-10TL	10	87	215	244	10	340x215x90	2,395



WHH-8TL

Usage example



Handle

Attach handle to wrench end.

Caution : Always verify that there is no rattling while the wrench is in use. Moreover, do not use the handle with any hexagon wrench other than the compatible H-size.

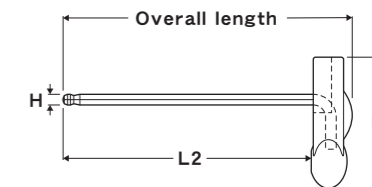

## TLS-9NX DOUBLE DECKER TYPE HOLDER SET

SILK SCREEN PRINTED

■ SNCM+V® special ■ Hard chrome plated

Metric size (Slide blister pack)

Item No.	Pcs.	H								Inner	W x H x D	g	
TLS-9NX	9	*1.5	*2	2.5	3	4	5	6	8	10	5	305x100x110	2,436

※No silk screen print for 1.5-2mm sizes.

## TLS-7SX FLAT TYPE HOLDER SET

Metric size (Slide blister pack)

Item No.	Pcs.	H						Inner	W x H x D	g	
TLS-7SX	7	*1.5	*2	2.5	3	4	5	6	10	260x160x50	1,539

※No silk screen print for 1.5-2mm sizes.



TLS-9NX

TLS-7SX

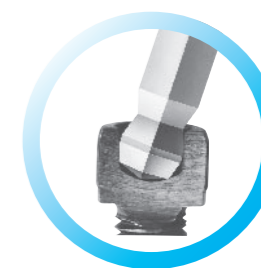

"TAPER HEAD"



● SIZE IS PRINTED 2.5-10mm

● For larger sizes over 2.5 mm, silk screen printing of the sizes for easy access.

EXCELLENT SERIES

STANDARD SERIES

TX SERIES

L type

KNIFE type

SOCKET DRIVER type

T type

SOCKET BIT type

BIT type

EXCELLENT SERIES

STANDARD SERIES

TX SERIES

L type

KNIFE type

SOCKET DRIVER type

T type

SOCKET BIT type

BIT type



# "TAPER HEAD" HEXAGON WRENCH

EXTRA LONG LENGTH

## TLS-\* FLAT TYPE HOLDER SET

■ SNCM+V® special ■ Hard chrome plated

Metric size (Slide blister pack)

Item No.	Pcs.	H	Inner	W x H x D	g
TLS-6	6	1.5 2 2.5 3 4 5	10	235x150x50	973
TLS-7	7	2.5 3 4 5 6 8 10	5	310x120x63	2,316
TLS-7S	7	1.5 2 2.5 3 4 5 6	10	255x160x50	1,535
TLS-8	8	1.5 2 2.5 3 4 5 6 8	5	290x103x58	1,359
TLS-9	9	1.5 2 2.5 3 4 5 6 8 10	5	312x120x65	2,343

- Plastic holder enables easy storage and removal of wrenches, and offers secure storage and handy carrying



TLS-9



TLS-7S



TLS-8



TLS-6

# "TAPER HEAD" HEXAGON WRENCH

EXTRA LONG LENGTH

## TLS-11 METAL CASE SET

■ SNCM+V® special ■ Hard chrome plated

Metric size (Metal case)

Item No.	Pcs.	H	Outer	W x H x D	g
TLS-11	11	1.5 2 2.5 3 4 5 6 8 10 12 14	10	320x193x178	16,220

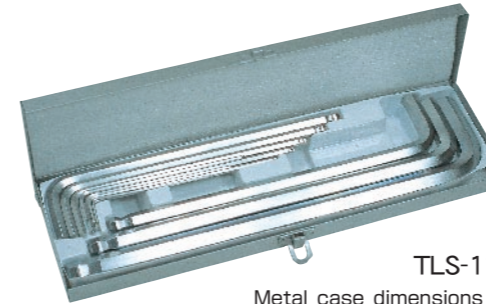

TLS-11

Metal case dimensions :  
306×86×30mm

- Tough metal case can be used as tool box.

## TLS / TEL-\*D DOOR HOLDER SET

■ SNCM+V® special ■ Hard chrome plated

Metric and Inch size (Slide blister pack)

Item No.	Pcs.	H	Inner	W x H x D	g
TLS-9D	9	1.5 2 2.5 3 4 5 6 8 10	5	320x100x110	2,540
TLS-8D	8	1.5 2 2.5 3 4 5 6 8	5	280x92x95	1,498
TLS-7SD	7	1.5 2 2.5 3 4 5 6	10	255x154x90	1,763
TEL-S9ZD	9	1/16 5/64 3/32 1/8 5/32 3/16 1/4 5/16 3/8	5	320x103x110	2,456

- Easy operation and innovative design of hexagon wrench holder.



TLS-9D

## EIGHT ORIGINAL PATENTED PRODUCTS

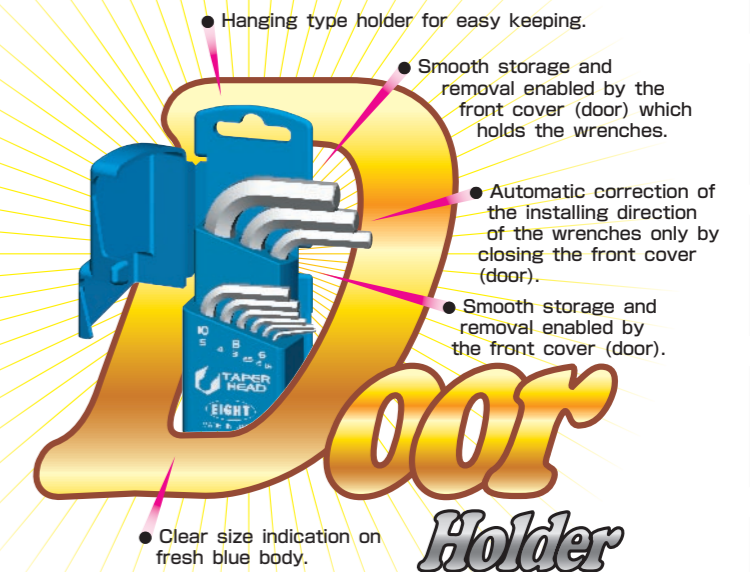

**Door Holder**

# "TAPER HEAD" BOLT CATCH HEXAGON WRENCH

EXTRA LONG LENGTH

## BCT-S9 DOUBLE DECKER TYPE HOLDER SET

■ SNCM+V<sup>®</sup> special ■ Hard chrome plated

"TAPER HEAD" and "FIT RING" come together to create a harmony of high workability, durability and torsional torque.



BCT-S9

Metric size (Slide blister pack)

Item No.	Pcs.	H	Inner	W x H x D	g
BCT-S9	9	*1.5 *2 2.5 3 4 5 6 8 10	5	305x100x110	2,431

※No "FIT RING" for 1.5 and 2 mm.

### CATCHES THE BOLT SECURELY !

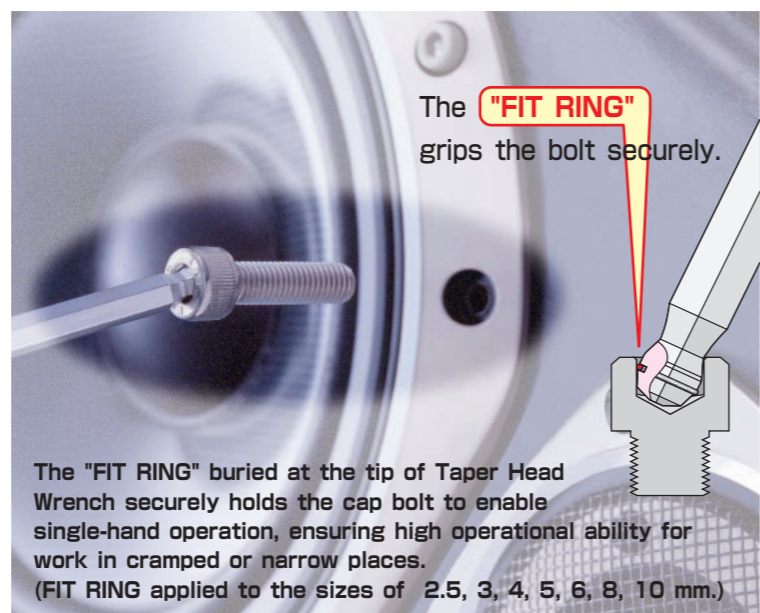

## BCT-S\* FLAT TYPE HOLDER SET

Metric size (Slide blister pack)

Item No.	Pcs.	H	Inner	W x H x D	g
BCT-S7	7	2.5 3 4 5 6 8 10	5	313x122x65	2,330
BCT-S5	5	2.5 3 4 5 6	10	258x160x50	1,510



BCT-S7

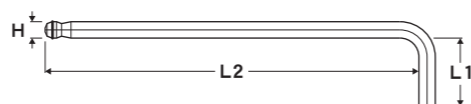

## BCT-\* INDIVIDUAL

Metric size (Slide blister pack)

Item No.	H	L1	L2	Inner	W x H x D	g
BCT-2.5	2.5	18	110	10	173x70x53	169
BCT-3	3	20	126	10	200x75x60	220
BCT-4	4	25	142	10	200x75x60	332
BCT-5	5	28	160	10	243x95x68	538
BCT-6	6	32	180	10	243x95x68	737
BCT-8	8	36	200	5	285x93x68	693
BCT-10	10	40	224	5	285x93x68	1,072

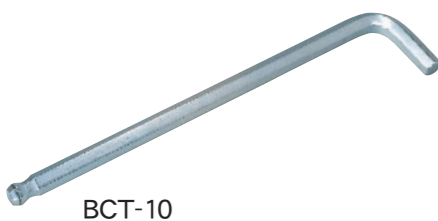

BCT-10

# "TAPER HEAD" SPECIAL SHORT ARM HEXAGON WRENCH

STANDARD LENGTH

## TTS-\* FLAT TYPE HOLDER SET

■ SNCM+V<sup>®</sup> special ■ Hard chrome plated

Metric size (Slide blister pack)

Item No.	Pcs.	H	Inner	W x H x D	g
TTS-9	9	1.5 2 2.5 3 4 5 6 8 10	5	312x120x65	2,169
TTS-7	7	1.5 2 2.5 3 4 5 6	10	257x160x50	1,437

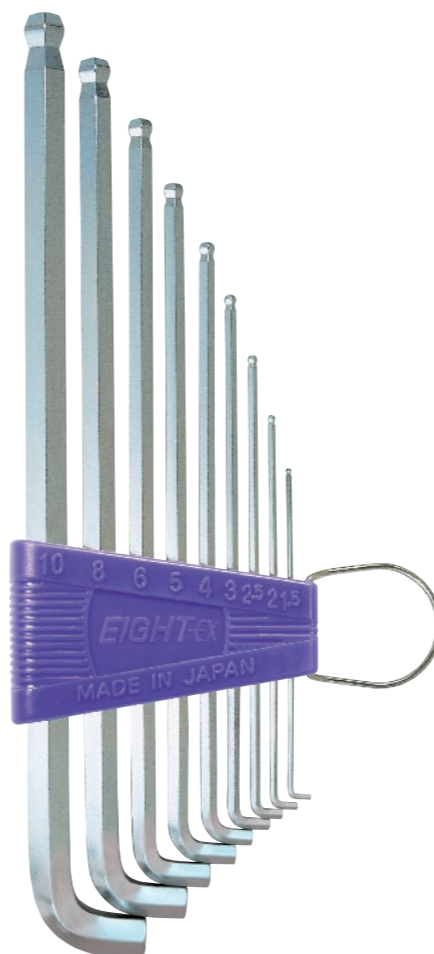

TTS-9



TTS-7

## IDEAL SPECIAL SHORT ARM FOR EASY WORK IN CRAMPED PLACES

- The "SPECIAL SHORT ARM" L1 length is designed to be 1/2 as short as other wrenches to allow easy work in cramped places.
- The "SPECIAL SHORT ARM" is made with a 95 degree bend for high workability in small spaces without risk of pinched fingers.

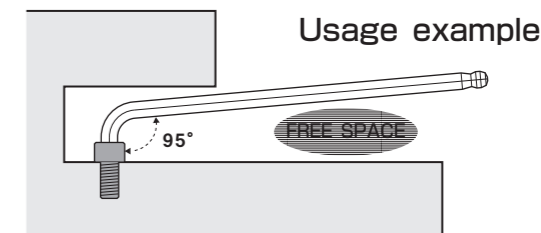

## TT-\*P INDIVIDUAL

■ SNCM+V<sup>®</sup> special ■ Hard chrome plated

Metric size (Slide blister pack)

Item No.	H	L1	L2	Inner	W x H x D	g
TT-1.5P	1.5	4	79	10	172x70x50	121
TT-2P	2	5	95	10	172x70x50	141
TT-2.5P	2.5	6	110	10	172x70x50	161
TT-3P	3	8	126	10	201x68x58	217
TT-4P	4	9	142	10	201x68x58	300
TT-5P	5	11	160	10	245x93x68	495
TT-6P	6	13	180	10	245x93x68	672
TT-8P	8	16	200	10	285x140x85	1,258
TT-10P	10	19	220	10	285x140x85	1,928

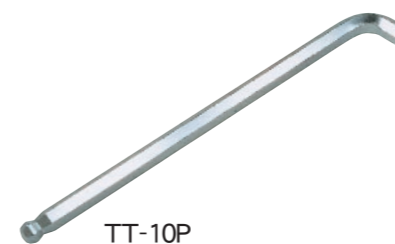

TT-10P

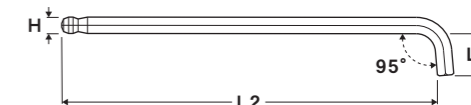

# "TAPER HEAD" SPECIAL SHORT ARM HEXAGON WRENCH

STANDARD LENGTH

## TTR-S\* FLAT TYPE HOLDER SET

■ SNCM+V® special ■ Hard chrome plated

Metric and Inch size (Slide blister pack)

Item No.	Pcs.	H								Inner	W x H x D	g	
TTR-S9	9	1.5	2	2.5	3	4	5	6	8	10	5	197x115x75	1,242
TTR-S9Z	9	1/16	5/64	3/32	1/8	5/32	3/16	1/4	5/16	3/8	5	197x115x75	1,187



TTR-S9

## IDEAL LENGTH FOR EASY WORK IN CRAMPED PLACES

- Standard length (L2) suitable for works in narrow and cramped places.

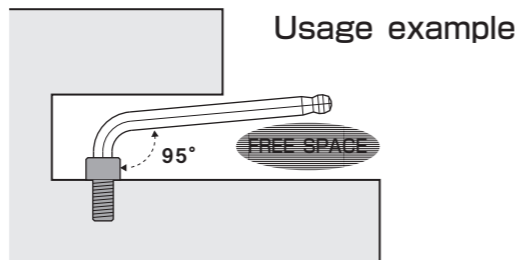

Usage example

## TTR-\* INDIVIDUAL

■ SNCM+V® special ■ Hard chrome plated

Metric size (Bulk pack)

Item No.	H	L1	L2	Inner	W x H x D	g
TTR-1.5	1.5	4	52	20	125x62x31	43
TTR-2	2	5	58	20	125x62x31	63
TTR-2.5	2.5	6	60	20	125x62x31	83
TTR-3	3	8	65	20	125x62x31	103
TTR-4	4	9	72	20	125x62x31	203
TTR-5	5	11	80	20	125x62x31	323
TTR-6	6	13	90	20	125x62x31	523
TTR-8	8	16	100	10	163x67x30	531
TTR-10	10	19	112	10	163x67x30	901



TTR-10

Inch size (Bulk pack)

Item No.	H	L1	L2	Inner	W x H x D	g
TTR-1/16	1/16"	4	47	20	125x62x31	43
TTR-5/64	5/64"	5	50	20	125x62x31	43
TTR-3/32	3/32"	6	56	20	125x62x31	63
TTR-1/8	1/8"	8	60	20	125x62x31	103
TTR-5/32	5/32"	9	68	20	125x62x31	183
TTR-3/16	3/16"	11	74	20	125x62x31	283
TTR-1/4	1/4"	13	88	20	125x62x31	583
TTR-5/16	5/16"	16	98	10	163x67x30	511
TTR-3/8	3/8"	18	110	10	163x67x30	801

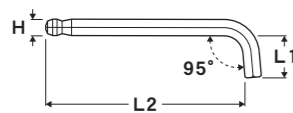

# ALL NEW BALL POINT HEXAGON WRENCH

# BALL POINT HEXAGON WRENCH

EXTRA LONG LENGTH

## BHC-S9N DOUBLE DECKER TYPE HOLDER SET

COLOR WRENCH ■ SNCM+V® special ■ Hard chrome plated

## COLOR HEXAGON WRENCH



SILK SCREEN PRINTED



BHC-S9N

## EASY ACCESS AT A GLANCE ! COLORS STANDING FOR SIZES

Metric size (Slide blister pack)

Item No.	Pcs.	H								Inner	W x H x D	g	
BHC-S9N	9	1.5	2	2.5	3	4	5	6	8	10	5	305x100x110	2,436

Specific production for same color set is available.

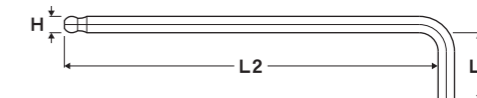

BALL POINT

## BHC-\* INDIVIDUAL

Metric size (Poly bag with header)

Item No.	H	L1	L2	Inner	W x H x D	g
BHC-1.5	1.5	16	79	10	165x70x33	51
BHC-2	2	17	95	10	165x70x33	68
BHC-2.5	2.5	18	110	10	165x70x33	90
BHC-3	3	20	126	10	204x67x30	137
BHC-4	4	25	142	10	228x67x30	235
BHC-5	5	28	160	10	250x74x30	241
BHC-6	6	32	180	10	252x90x31	576
BHC-8*	8	36	200	10	252x90x31	1,083
BHC-10*	10	40	224	10	252x90x31	1,841

※Bulk pack for BHC-8 and BHC-10

## BHS-9NP DOUBLE DECKER TYPE HOLDER SET WITH EXTENSION PIPE

WITH EXTENSION PIPE ■ SNCM+V® special ■ Hard chrome plated

## WITH EXTENSION PIPES 2pcs.



Extension two way pipes attached offering high torque transmission.

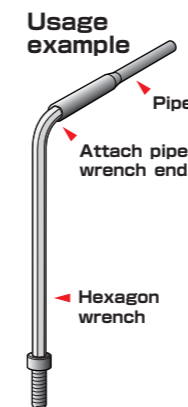

WP-S2

BHS-9NP

Metric size with pipes (Slide blister pack)

Item No.	Pcs.	H								Inner	W x H x D	g	
BHS-9NP	9	1.5	2	2.5	3	4	5	6	8	10 & PIPES	5	307x105x125	3,129

To Remove The Pipes

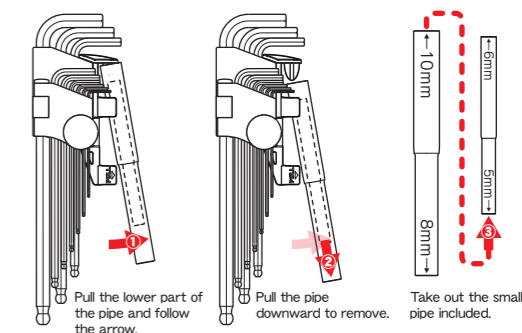

\* To store the pipes, reverse the instructions above.

## WP-S2 EXTENSION PIPES SET

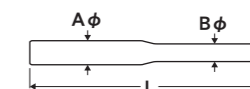

Extension pipes (Poly bag with header)

Item No.	Pcs.	Pipe size against wrench (H)	L	Aφ	Bφ	Inner	W x H x D	g
WP-S2	2	Pipe L : 8 ⇔ 10 mm Pipe S : 5 ⇔ 6 mm	150 110	15.9 9.5	13.8 8.0	10	245x93x68	1,312

# BALL POINT HEXAGON WRENCH

EXTRA LONG LENGTH

## BHS-9N DOUBLE DECKER TYPE HOLDER SET

■ SNCM+V<sup>®</sup> special ■ Hard chrome plated

Metric size (Slide blister pack)

Item No.	Pcs.	H								Inner	W x H x D	g	
BHS-9N	9	1.5	2	2.5	3	4	5	6	8	10	5	305x100x110	2,436

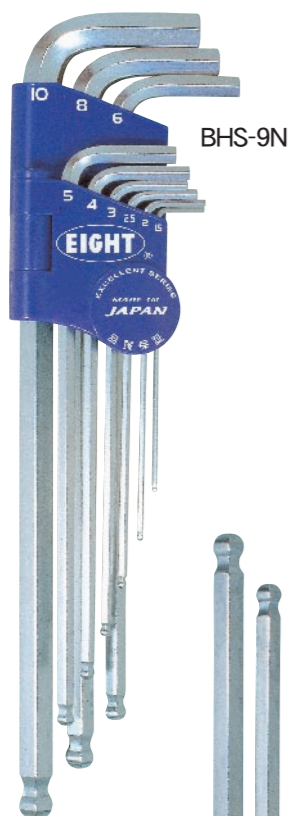

BHS-9N



**BALL POINT**

## BHS-\* FLAT TYPE HOLDER SET

Metric size (Slide blister pack)

Item No.	Pcs.	H								Inner	W x H x D	g	
BHS-7	7	1.5	2	2.5	3	4	5	6		10	258x158x50	1,535	
BHS-8	8	1.5	2	2.5	3	4	5	6	8	5	290x105x52	1,358	
BHS-9	9	1.5	2	2.5	3	4	5	6	8	10	5	313x120x65	2,353

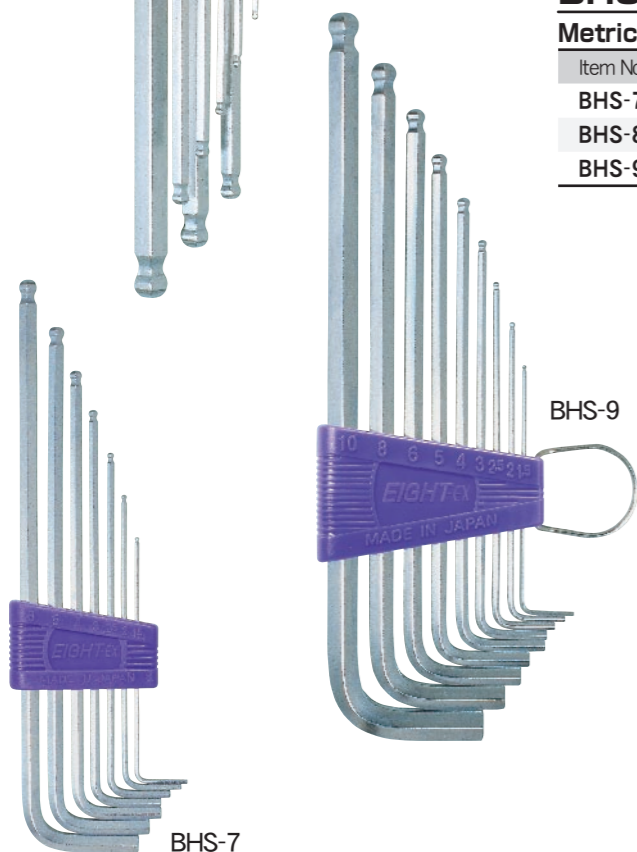

BHS-9

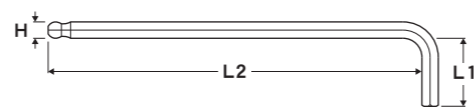

## BH-\* INDIVIDUAL

Metric size (Slide blister pack)

Item No.	H	L1	L2	Inner	W x H x D	g
BH-1.5	1.5	16	79	10	170x68x50	127
BH-2	2	17	95	10	170x68x50	144
BH-2.5	2.5	18	110	10	170x68x50	167
BH-3	3	20	126	10	200x70x60	219
BH-4	4	25	142	10	200x70x60	323
BH-5	5	28	160	10	240x90x68	534
BH-6	6	32	180	10	240x90x68	730
BH-8	8	36	200	10	285x140x80	1,333
BH-10	10	40	224	10	285x140x80	2,120



BH-10

# BALL POINT HEXAGON WRENCH

EXTRA LONG LENGTH

## BHS-\*X FLAT TYPE HOLDER SET

SILK SCREEN PRINTED

■ SNCM+V<sup>®</sup> special ■ Hard chrome plated

Metric size (Slide blister pack)

Item No.	Pcs.	H								Inner	W x H x D	g	
BHS-7X	7	※1.5	※2	2.5	3	4	5	6		10	258x158x50	1,533	
BHS-9X	9	※1.5	※2	2.5	3	4	5	6	8	10	5	313x120x65	2,353

※No silk screen print for 1.5-2mm sizes.



BHS-9X

● Size printing applied to 2.5 - 10 mm wrenches.



## BHS-\*D DOOR HOLDER SET

■ SNCM+V<sup>®</sup> special ■ Hard chrome plated

Metric size (Slide blister pack)

Item No.	Pcs.	H								Inner	W x H x D	g	
BHS-9D	9	1.5	2	2.5	3	4	5	6	8	10	5	322x104x110	2,551
BHS-8D	8	1.5	2	2.5	3	4	5	6	8		5	282x93x95	1,510
BHS-7D	7	1.5	2	2.5	3	4	5	6			10	256x155x90	1,760



BHS-9D

● Easy operation and innovative design of hexagon wrench holder.

**NEW**

# HEXAGON WRENCH

EXTRA LONG LENGTH

**LHS-9NP** DOUBLE DECKER TYPE HOLDER SET WITH EXTENSION PIPES **WITH EXTENSION PIPE** ■ SNCM+V® special ■ Hard chrome plated

## WITH EXTENSION PIPES **2 pcs.**



Extension two way pipes attached offering high torque transmission.

Usage example

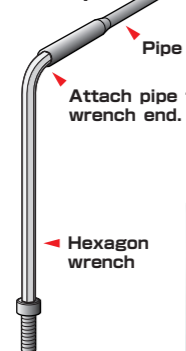

Caution: Please be careful not to overtighten. Do not use any hexagon wrench other than the compatible H-size on the pipe.

WP-S2

LHS-9NP

Metric size with pipes (Slide blister pack)

Item No.	Pcs.	H	Inner	W x H x D	g
<b>NEW</b> LHS-9NP	9	1.5 2 2.5 3 4 5 6 8 10 & PIPES	5	307x105x125	3,159

To Remove The Pipes

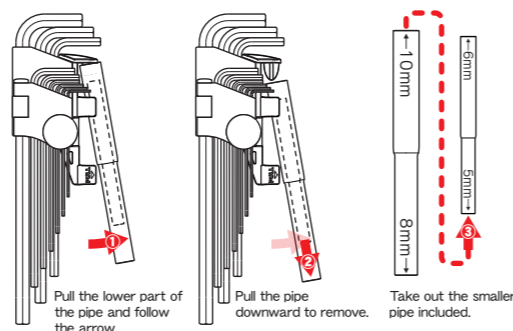

\* To store the pipes, reverse the instructions above.

## WP-S2 EXTENSION PIPES SET

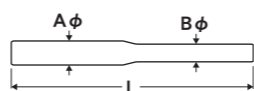

Extension pipes (Poly bag with header)

Item No.	Pcs.	Pipe size against wrench (H)	L	Aφ	Bφ	Inner	W x H x D	g
WP-S2	2	Pipe L : 8 ⇔ 10 mm	150	15.9	13.8	10	245x93x68	1,312
		Pipe S : 5 ⇔ 6 mm	110	9.5	8.0			

**LHS-\*** HOLDER SET

■ SNCM+V® special ■ Hard chrome plated

Metric size (Slide blister pack)

Item No.	Pcs.	H	Inner	W x H x D	g
LHS-9N	9	1.5 2 2.5 3 4 5 6 8 10	5	305x100x110	2,436

- Front folder rises up for easy removed and storage.
- Front and back folders can be separated by pulling out the linkage pin.

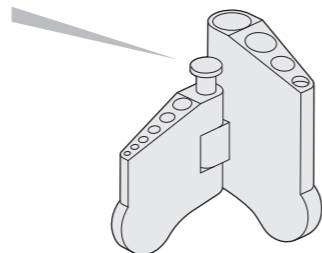

Metric size (Slide blister pack)

Item No.	Pcs.	H	Inner	W x H x D	g
LHS-7	7	1.5 2 2.5 3 4 5 6	10	255x160x50	1,535
LHS-9	9	1.5 2 2.5 3 4 5 6 8 10	5	312x120x65	2,349

- Plastic holder enables easy storage and removal of wrenches, and offers secure storage and handy carrying.

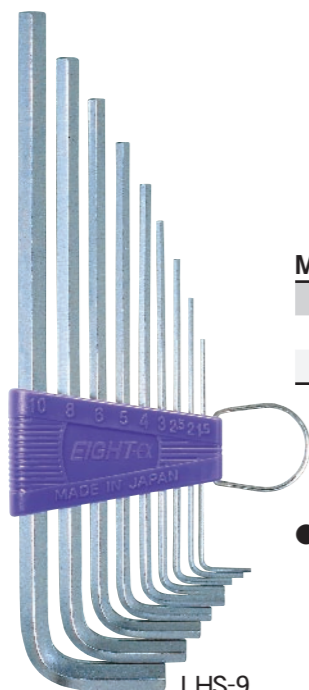
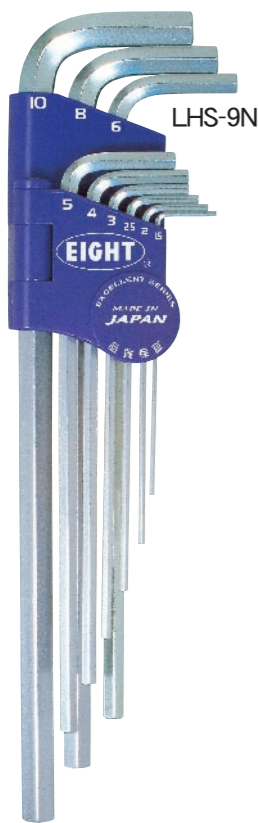

LHS-9

# HEXAGON WRENCH

EXTRA LONG LENGTH

**LH-\*** INDIVIDUAL

■ SNCM+V® special ■ Hard chrome plated

Metric size (Slide blister pack)

Item No.	H	L1	L2	Inner	W x H x D	g
LH-1.5	1.5	16	79	10	170x68x50	129
LH-2	2	17	95	10	170x68x50	143
LH-2.5	2.5	18	110	10	200x70x59	171
LH-3	3	20	126	10	200x70x59	229
LH-4	4	25	142	10	243x93x67	324
LH-5	5	28	160	10	243x93x67	538
LH-6	6	32	180	10	285x138x84	734
LH-8	8	36	200	10	285x138x84	1,365
LH-10	10	40	224	10	285x138x84	2,143
LH-12	12	45	250	4	355x105x62	1,424
LH-14	14	55	280	4	355x105x62	2,060
LH-17*	17	60	320	4	347x100x40	3,094
LH-19*	19 (3/4")	70	360	4	410x95x45	4,336

\*Bulk pack for LH-17 and LH-19

Inch size (Bulk pack)

Item No.	H	L1	L2	Inner	W x H x D	g
LH-1/16	1/16"	15	79	20	163x68x30	77
LH-5/64	5/64"	17	93	20	163x68x30	93
LH-3/32	3/32"	18	108	20	163x68x30	133
LH-1/8	1/8"	20	127	20	163x68x30	233
LH-5/32	5/32"	25	140	20	163x68x30	373
LH-3/16	3/16"	28	158	20	202x68x30	593
LH-1/4	1/4"	32	178	20	250x90x35	1,176
LH-5/16	5/16"	36	198	10	250x90x35	1,026
LH-3/8	3/8"	40	222	10	250x90x35	1,660



LH-10

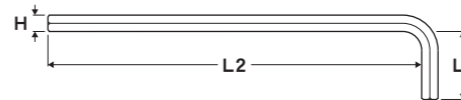

**LHS-\*D** DOOR HOLDER SET

■ SNCM+V® special ■ Hard chrome plated

Metric and Inch size (Slide blister pack)

Item No.	Pcs.	H	Inner	W x H x D	g
LHS-9D	9	1.5 2 2.5 3 4 5 6 8 10	5	322x104x110	2,566
LHS-8D	8	1.5 2 2.5 3 4 5 6 8	5	282x93x95	1,514
LHS-7D	7	1.5 2 2.5 3 4 5 6	10	255x154x90	1,761
LHS-9ZD	9	1/16 5/64 3/32 1/8 5/32 3/16 1/4 5/16 3/8	5	322x104x110	2,478



LHS-9D



LHS-7D

- Easy operation and innovative design of hexagon wrench holder.

# "TAPER HEAD" HEXAGON WRENCH

LONG LENGTH

## TMS-\* DOUBLE DECKER TYPE HOLDER SET

■ SNCM+V<sub>6</sub> special ■ Hard chrome plated

Metric size (Slide blister pack)

Item No.	Pcs.	H	Inner	W x H x D	g
TMS-7	7	*1.5 *2 2.5 3 4 5 6	10	212x161x50	1,233
TMS-9	9	*1.5 *2 2.5 3 4 5 6 8 10	5	250x105x132	2,005

※No silk screen print for 1.5-2mm sizes.

- SUPER BALL POINT is the name given to "TAPER HEAD" wrenches of Long Length to distinguish from the original "TAPER HEAD" of Extra Long Length.



"TAPER HEAD"



TMS-7



TMS-9



TM-4

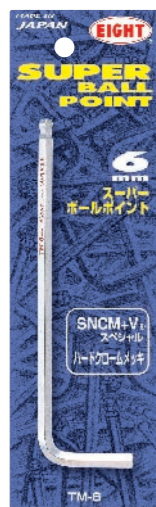

TM-6



TM-10



TL-3/8

## TM / TL-\* INDIVIDUAL

Metric size (Slide blister pack)

Item No.	H	L1	L2	Inner	W x H x D	g
TM-1.5*	1.5	16	79	10	172x68x50	125
TM-2 *	2	17	86	10	172x68x50	139
TM-2.5	2.5	18	94	10	172x68x50	158
TM-3	3	20	101	10	172x68x50	183
TM-4	4	25	110	10	172x68x50	257
TM-5	5	28	120	10	215x90x63	407
TM-6	6	32	133	10	215x90x63	559
TM-8	8	36	154	10	247x135x78	1,085
TM-10	10	40	172	10	247x135x78	1,696

※No silk screen print for 1.5-2mm sizes.

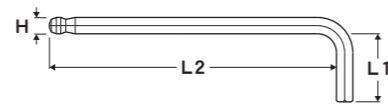

Inch size (Slide blister pack)

Item No.	H	L1	L2	Inner	W x H x D	g
TL-0.05"	0.05" =1.27mm	14	75	10	170x68x50	121
TL-1/16	1/16"	15	79	10	170x68x50	127
TL-5/64	5/64"	17	84	10	170x68x50	137
TL-3/32	3/32"	17	92	10	170x68x50	151
TL-7/64	7/64"	19	96	10	200x70x58	200
TL-1/8	1/8"	20	102	10	200x70x58	221
TL-9/64	9/64"	23	104	10	200x70x58	250
TL-5/32	5/32"	25	108	10	200x70x58	300
TL-3/16	3/16"	28	118	10	240x93x68	438
TL-7/32	7/32"	30	125	10	240x93x68	538
TL-1/4	1/4"	32	135	10	240x93x68	664
TL-5/16	5/16"	36	152	10	285x140x85	1,136
TL-3/8	3/8"	40	170	10	285x140x85	1,615

※No silk screen print for all.

# HEXAGON WRENCH

LONG LENGTH

## MC-TMD MICRO SIZE TAPER HEAD SET

■ SNCM+V<sub>6</sub> special ■ Hard chrome plated

Metric size (Plastic case)

Item No.	Pcs.	H	Inner	W x H x D	g
MC-TMD	7	0.89 mm Hexagon screwdriver* hexagon : 1.27 1.5 2 2.5 3 4	10	180x165x105	943

※Hexagon screwdriver is black parkerized finish blade with plastic handle.



MC-TMD



- Precision Hexagon wrenches set suitable for various hobbies.
- Packed in plastic case for easy carrying.

Plastic case dimensions :  
140x70x20mm

## MICRO SIZE BALL POINT SET ■ SNCM+V<sub>6</sub> ■ Black parkerized finish

Metric size (Plastic case)

Item No.	Pcs.	H	Inner	W x H x D	g
MC-016D	7	0.89 mm Hexagon screwdriver* hexagon : 1.27 1.5 2 2.5 3 4	10	180x165x105	963



MC-016D



MC-008D

## MICRO SIZE HEXAGON WRENCH SET ■ SNCM+V<sub>6</sub> ■ Black parkerized finish

Metric size (Plastic case)

Item No.	Pcs.	H	Inner	W x H x D	g
MC-008D	7	0.89 mm Hexagon screwdriver* Hexagon : 1.27 1.5 2 2.5 3 4	10	180x165x105	963

## TMS / TLS-\*D TAPER HEAD DOOR HOLDER SET

■ SNCM+V<sub>6</sub> special ■ Hard chrome plated

Metric and Inch size (Slide blister pack)

Item No.	Pcs.	H	Inner	W x H x D	g
TMS-9D	9	1.5 2 2.5 3 4 5 6 8 10	10	258x184x125	4,105
TMS-7D	7	1.5 2 2.5 3 4 5 6	10	210x153x100	1,475
TLS-9ZD	9	1/16 5/64 3/32 1/8 5/32 3/16 1/4 5/16 3/8	5	260x103x122	2,028
TLS-8ZD	8	1/16 5/64 3/32 1/8 5/32 3/16 1/4 5/16	5	233x94x103	1,254
TLS-13ZD	13	0.05" 1/16 5/64 3/32 7/64 1/8 9/64 5/32 3/16 7/32 1/4 5/16 3/8	5	255x113x135	2,417



TMS-9D



TMS-7D

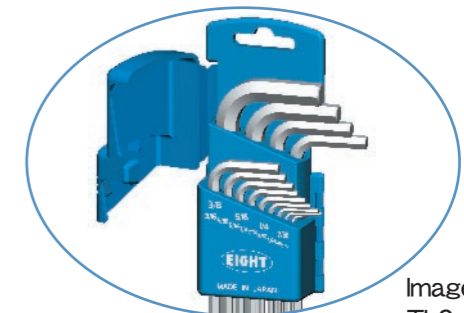

Image picture :  
TLS-13ZD

# "TAPER HEAD" HEXAGON WRENCH

STANDARD LENGTH

## TS-\* FLAT TYPE HOLDER SET

■ SNCM+V® special ■ Hard chrome plated



TS-9



TS-7S



T-10



TS-9D

Metric size (Slide blister pack)

Item No.	Pcs.	H	Inner	W x H x D	g
TS-6	6	1.5 2 2.5 3 4 5	10	155x140x60	610
TS-7	7	2.5 3 4 5 6 8 10	5	194x115x73	1,379
TS-7S	7	1.5 2 2.5 3 4 5 6	10	175x150x57	948
TS-8	8	1.5 2 2.5 3 4 5 6 8	5	190x104x55	808
TS-9	9	1.5 2 2.5 3 4 5 6 8 10	5	195x113x75	1,395

- Plastic holder enables easy storage and removal of wrenches, and offers secure storage and handy carrying.

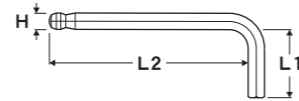

## T-\* INDIVIDUAL

Metric size (Slide blister pack)

Item No.	H	L1	L2	Inner	W x H x D	g
T-1.5	1.5	12	52	10	125x68x47	87
T-2	2	12	58	10	125x68x47	96
T-2.5	2.5	15	60	10	125x68x47	108
T-3	3	20	65	10	125x68x47	127
T-4	4	25	72	10	125x68x47	179
T-5	5	28	80	10	164x113x67	335
T-6	6	32	90	10	164x113x67	449
T-8	8	36	100	10	164x113x67	733
T-10	10	40	112	10	193x165x85	1,274
T-12*	12	45	125	10	164x110x40	1,703
T-14*	14	55	140	10	187x100x55	2,628
T-17*	17	60	160	4	187x100x55	1,773
T-19*	19 (3/4")	70	175	4	225x98x48	2,445

※Bulk pack for T12 - T 19

## TS-\*D DOOR HOLDER SET

Metric size (Slide blister pack)

Item No.	Pcs.	H	Inner	W x H x D	g
TS-9D	9	1.5 2 2.5 3 4 5 6 8 10	5	200x150x100	1,596
TS-8D	8	1.5 2 2.5 3 4 5 6 8	5	180x133x88	979
TS-7SD	7	1.5 2 2.5 3 4 5 6	10	161x154x100	1,153

- Easy operation and innovative design of hexagonal wrench holder.

# HEXAGON WRENCH

STANDARD LENGTH

## RS-\* FLAT TYPE HOLDER SET

■ SNCM+V® special ■ Hard chrome plated



RS-9



RS-9D

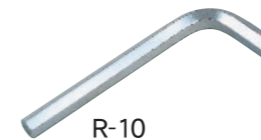

R-10

Metric size (Slide blister pack)

Item No.	Pcs.	H	Inner	W x H x D	g
RS-6	6	1.5 2 2.5 3 4 5	10	155x140x60	610
RS-7	7	1.5 2 2.5 3 4 5 6	10	175x157x59	966
RS-8	8	1.5 2 2.5 3 4 5 6 8	5	188x100x58	820
RS-9	9	1.5 2 2.5 3 4 5 6 8 10	5	195x113x75	2,160

## RS-\*D DOOR HOLDER SET

Metric and Inch size (Slide blister pack)

Item No.	Pcs.	H	Inner	W x H x D	g
RS-9D	9	1.5 2 2.5 3 4 5 6 8 10	5	200x150x100	1,623
RS-7D	7	1.5 2 2.5 3 4 5 6	10	167x150x100	1,166
RS-8ZD	8	1/16 5/64 3/32 1/8 5/32 3/16 1/4 5/16	5	180x133x88	966
RS-13ZD	13	0.05" 1/16 5/64 3/32 7/64 1/8 9/64 5/32 3/16 7/32 1/4 5/16 3/8	5	192x150x108	1,829

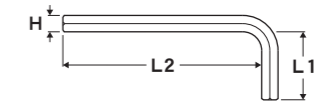

## R-\* INDIVIDUAL

Metric size (Slide blister pack)

Item No.	H	L1	L2	Inner	W x H x D	g
R-1.5	1.5	12	52	10	127x69x47	85
R-2	2	12	58	10	127x69x47	94
R-2.5	2.5	15	60	10	127x69x47	107
R-3	3	20	65	10	127x69x47	126
R-4	4	25	72	10	127x69x47	181
R-5	5	28	80	10	162x110x70	336
R-6	6	32	90	10	162x110x70	451
R-8	8	36	100	10	162x110x70	745
R-10	10	40	112	10	196x163x88	1,294
R-12	12	45	125	10	196x163x88	1,951
R-14	14	55	140	10	213x205x90	2,977
R-17*	17	60	160	4	190x103x55	1,818
R-19*	19 (3/4")	70	175	4	224x98x45	2,510

※Bulk pack for R-17 and R-19

Inch size (Bulk pack)

Item No.	H	L1	L2	Inner	W x H x D	g
R-0.05"	0.05"-1.27mm	14	46	20	125x65x30	43
R-1/16	1/16"	13	47	20	125x65x30	43
R-5/64	5/64"	14	50	20	125x65x30	57
R-3/32	3/32"	17	56	20	125x65x30	84
R-7/64	7/64"	18	58	20	125x65x30	104
R-1/8	1/8"	20	59.5	20	125x65x30	124
R-9/64	9/64"	22	65	20	125x65x30	175
R-5/32	5/32"	24	68	20	125x65x30	224
R-3/16	3/16"	25	75	20	125x65x30	324
R-7/32	7/32"	27	81	20	125x65x30	464
R-1/4	1/4"	30	88	20	125x65x30	669
R-5/16	5/16"	34	98	10	163x70x33	594
R-3/8	3/8"	37	110	10	163x70x33	941
R-1/2	1/2"	45	125	10	163x110x44	1,945
R-3/4	3/4"	70	175	4	224x98x45	2,510

# "TAPER HEAD" COLOR DIPPED HEXAGON WRENCH

SUPER LONG LENGTH

## TLLB-S9N DOUBLE DECKER TYPE HOLDER SET

■ SNCM+V<sup>®</sup>special ■ Hard chrome plated

Metric size (Paper pack)

Item No.	Pcs.	H								Inner	W x H x D	g	
TLLB-S9N	9	1.5	2	2.5	3	4	5	6	8	10	6	370x173x70	3,517

**HARD TIGHTENING ENSURED BY SUPER LONG ARM !**

**PVC DIPPED FINISH IN DIFFERENT COLORS STANDING FOR SIZES**

- **SUPER LONG :**  
15-30 % longer than extra long length specification.
- **COLORING :**  
Easy access to the required size at a glance of colors.
- **SAFETY :**  
PVC cover offers a high degree of safety, preventing the dispersion of broken pipes if broken.

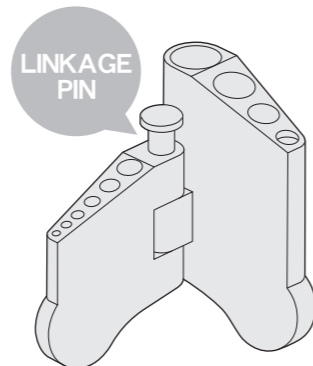

### TLLB-\* INDIVIDUAL

Metric size (Bulk pack)

Item No.	H	L1	L2	Inner	W x H x D	g
TLLB-1.5	1.5	16	91	10	163x68x30	53
TLLB-2	2	17	109	10	163x68x30	73
TLLB-2.5	2.5	18	132	10	163x68x30	103
TLLB-3	3	20	151	10	202x68x30	143
TLLB-4	4	25	170	10	223x74x30	262
TLLB-5	5	28	200	10	250x90x37	457
TLLB-6	6	32	225	10	250x90x37	697
TLLB-8	8	36	260	10	330x90x30	1,374
TLLB-10	10	40	291	10	348x103x40	2,337

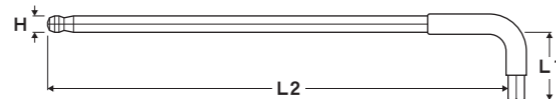

TLLB-S9N

# "TAPER HEAD" STAINLESS STEEL HEXAGON WRENCH

LONG LENGTH

## VS-\* PLASTIC CASE SET

■ Stainless steel ■ Hard chrome plated

Metric size (Plastic case)

Item No.	Pcs.	H								Outer	W x H x D	g
VS-7C	7	2.5	3	4	5	6	8	10	10	290x217x206	6,045	
VS-S6	6	2.5	3	4	5	6	8		20	385x203x196	6,550	

**THE HIGHEST RUST PREVENTION, ENSURED BY A SPECIFIC STAINLESS STEEL TREATMENT.**

- Stainless steel specially hardened and tempered to ensure high hardness of **HRC55-57**.
- Anticorrosive and abrasive-resistant, suitable for shipyard, foods, chemical, fishery, farm implement and/or marine sports fields.
- Round shank used for easy gripping and tight fastening.

- \* The raw material of this Stainless Steel is magnetizable.
- \* Three times higher anticorrosive effect compared to our standard material.



Plastic case dimensions : 203×133×37mm



Plastic case dimensions : 188×88×35mm

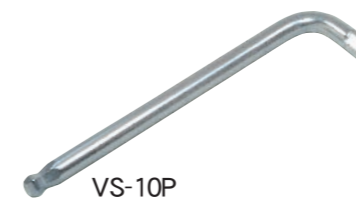

### VS-\* P INDIVIDUAL

Metric size (Slide blister pack)

Item No.	H	L1	L2	φ	Inner	W x H x D	g
VS-2.5P	2.5	18	95	3	10	170x66x52	170
VS-3P	3	20	104	4	10	170x66x52	219
VS-4P	4	24	112	5	10	214x90x65	368
VS-5P	5	28	123	6	10	214x90x65	481
VS-6P	6	31	136	7	10	214x90x65	653
VS-8P	8	34	160	9.4	10	250x137x80	1,260
VS-10P	10	38	178	11.7	10	250x137x80	2,089

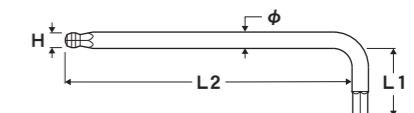



# “TAPER HEAD” HEXAGON SCREWDRIVER

PLASTIC HANDLE

TD-\* INDIVIDUAL

■ SNCM+V® special ■ Hard chrome plated blade

FROM PRE-FASTENING TO FINAL TIGHT FASTENING IN A SINGLE PIECE !



“TAPER HEAD”



TD-2

Metric size (Bulk pack)

Item No.	H	L1	L2	φ	Inner	W x H x D	g
TD-1.3	1.27 (0.05")	60	82	11	10	164x70x32	131
TD-1.5	1.5	70	82	11	10	164x70x32	133
TD-1.6	1.59 (1/16")	70	82	11	10	164x70x32	136
TD-2	2	80	87	15	10	204x60x29	207

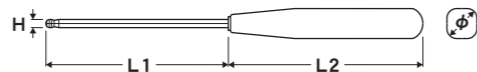

- Long blade permits high workability in deep or narrow places.
- TD-4~6, TD-3/16~1/4 are with extension L-type wrench.
- High quality acetate plastic handle is resistant to both oil and chemicals, is extremely durable, and prevents slippage and damage from impact while being easy on the hands.

Metric and Inch size (Slide blister pack)

Item No.	H	L1	L2	φ	Inner	W x H x D	g
TD-2.5	2.5	90	85	18	10	240x120x43	406
TD-3	3	100	94	21	10	262x148x57	610
TD-4	4	125	102	26	10	290x165x63	1,073
TD-5	5	140	109	30	5	335x134x40	853
TD-6	6	150	109	30	5	335x134x40	975
TD-3/32	3/32"	90	85	18	10	240x120x43	408
TD-7/64	7/64"	95	94	21	10	240x120x43	458
TD-1/8	1/8"	100	94	21	10	240x120x43	648
TD-9/64	9/64"	110	94	21	10	290x167x62	778
TD-5/32	5/32"	125	102	26	10	290x167x62	1,078
TD-3/16	3/16"	140	109	30	5	332x133x48	843
TD-7/32	7/32"	145	109	30	5	332x133x48	938
TD-1/4	1/4"	150	109	30	5	332x133x48	1,008

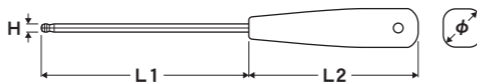

TD-6

# HEXAGON SCREWDRIVER

PLASTIC HANDLE

DS-6 VINYL POUCH SET

■ SNCM+V® special ■ Hard chrome plated blade

Metric size (Vinyl pouch)

Item No.	Pcs.	H						Inner	W x H x D	g
DS-6	6	0.71	0.89	1.27	1.5	1.59	2	5	245x94x68	498

※0.71 and 0.89 are black parkerized finish blade.



- Large-size plastic handle provides high operational ability suitable for precision work.
- High quality acetate plastic handle is resistant to both oil and chemicals, is extremely durable, and prevents slippage and damage from impact while being easy on the hands.

D-\* INDIVIDUAL

■ SNCM+V® special ■ Hard chrome plated blade

Metric size (Bulk pack)

Item No.	H	L1	L2	φ	Inner	W x H x D	g
D-0.7	0.71 (0.028")	35	74	8	10	164x70x32	66
D-0.9	0.89 (0.035")	40	74	8	10	164x70x32	69
D-1.3	1.27 (0.05")	60	82	11	10	164x70x32	129
D-1.5	1.5	70	87	15	10	164x70x32	191
D-1.6	1.59 (1/16")	70	87	15	10	164x70x32	191
D-2	2	80	85	18	10	204x60x29	261

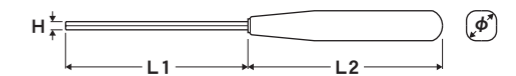

Black parkerized finish  
D-0.7~0.9

D-1.6

D-6

Metric size (Slide blister pack)

Item No.	H	L1	L2	φ	Inner	W x H x D	g
D-2.5	2.5	90	85	18	10	240x120x43	406
D-3	3	100	94	21	10	262x148x57	650
D-4	4	125	102	26	10	290x165x63	1,147
D-5	5	140	109	30	5	335x134x40	789
D-6	6	150	109	30	5	335x134x40	997

- D-3~6 are with extension L-type wrench.

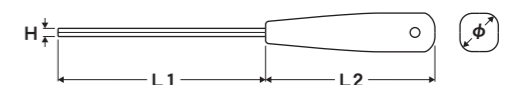

# T TYPE "TAPER HEAD" BOLT CATCH HEXAGON WRENCH

STEEL HANDLE

## BCTT500-\* INDIVIDUAL

500 mm length

■ SNCM+V® special ■ Hard chrome plated blade

"TAPER HEAD" and "FIT RING" come together to create a harmony of high workability, durability and torsional torque.

### Metric size (Hanging header)

Item No.	H	L1	L2	L3	φ	Inner	W x H x D	g
BCTT500-2.5	2.5	80	25	500	8	10	545x111x48	2,403
BCTT500-3	3	80	25	500	8	10	545x111x48	2,403
BCTT500-4	4	100	35	500	8	10	545x111x48	2,457
BCTT500-5	5	120	50	500	10	10	545x133x56	3,810
BCTT500-6	6	160	50	500	12	10	548x170x76	5,726
BCTT500-8	8	180	60	500	14	10	548x192x90	8,215

CATCHES THE BOLT SECURELY !

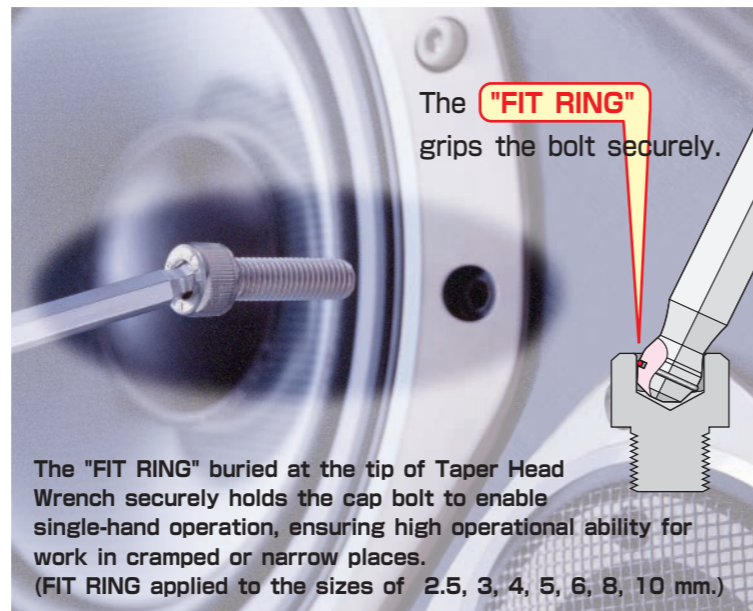

## BCTT-\* INDIVIDUAL

Standard length

### Metric size (Hanging header)

Item No.	H	L1	L2	L3	φ	Inner	W x H x D	g
BCTT-2.5	2.5	80	25	190	8	10	205x95x70	1,087
BCTT-3	3	80	25	190	8	10	205x95x70	1,088
BCTT-4	4	100	35	200	8	10	225x110x80	1,207
BCTT-5	5	120	50	250	10	10	290x135x90	2,215
BCTT-6	6	160	50	250	12	10	325x177x67	2,472
BCTT-8	8	180	60	300	14	10	340x215x97	5,627

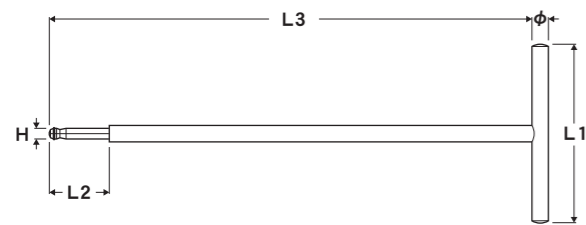
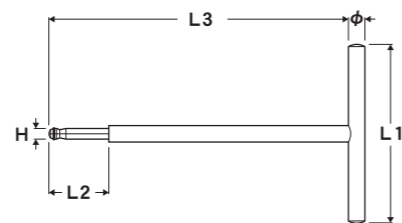

# T TYPE "TAPER HEAD" HEXAGON WRENCH

STEEL HANDLE

## STT500-\* INDIVIDUAL

500 mm length

■ SNCM+V® special ■ Hard chrome plated blade

### Metric size (Hanging header)

Item No.	H	L1	L2	L3	φ	Inner	W x H x D	g
STT500-3	3	80	25	500	8	10	545x112x48	2,403
STT500-4	4	100	35	500	8	10	545x112x48	2,457
STT500-5	5	120	50	500	10	10	545x133x56	3,810
STT500-6	6	160	50	500	12	10	548x170x76	5,726
STT500-8	8	180	60	500	14	10	548x192x90	8,215

500 mm LENGTH BLADE ENSURE TO USE AT THE DEEP SPACE !

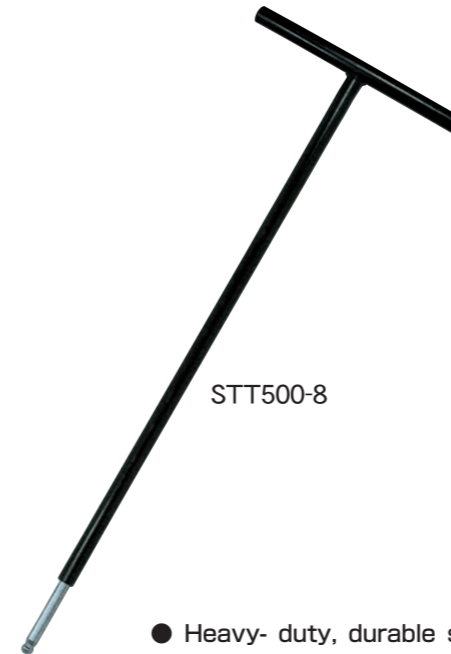
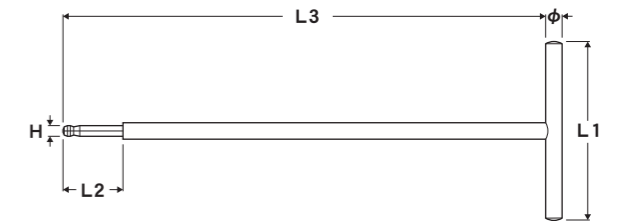

- Heavy-duty, durable steel handle.
- TAPER HEAD can be used with declining angle to avoid obstacles.
- Black finished steel handle and blade with hard chrome plated hexagon tip.

## STT-\* INDIVIDUAL

Standard length

■ SNCM+V® special ■ Hard chrome plated blade

### Metric size (Hanging header)

Item No.	H	L1	L2	L3	φ	Inner	W x H x D	g
STT-3	3	80	25	190	8	10	205x95x70	1,090
STT-4	4	100	35	200	8	10	225x110x80	1,196
STT-5	5	120	50	250	10	10	290x135x90	2,212
STT-6	6	160	50	250	12	10	325x177x67	3,506
STT-8	8	180	60	300	14	10	340x215x97	5,640
STT-10*	10	200	—	300	12	10	340x215x97	4,698
STT-12*	12	200	—	320	16	5	340x215x97	4,268
STT-14*	14	200	—	320	16	5	340x215x97	4,292



- The body and tip for STT-10-14 are made of one piece and the black parkerized finish ensures durability.

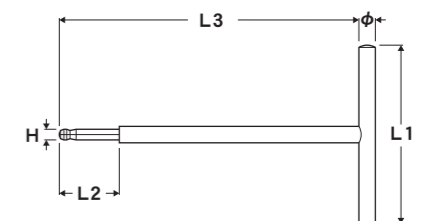

# T TYPE HEXAGON WRENCH

STEEL HANDLE

## ST500-\* INDIVIDUAL

500 mm length

■ SNCM+V® special ■ Hard chrome plated blade

Metric size (Hanging header)

Item No.	H	L1	L2	L3	φ	Inner	W x H x D	g
ST500-3	3	80	25	500	8	10	545x112x48	2,403
ST500-4	4	100	35	500	8	10	545x112x48	2,457
ST500-5	5	120	50	500	10	10	545x133x56	3,810
ST500-6	6	160	50	500	12	10	548x170x76	5,726
ST500-8	8	180	60	500	14	10	548x192x90	8,215

**500 mm LENGTH BLADE PERMITS WORKABILITY IN NARROW PLACES !**

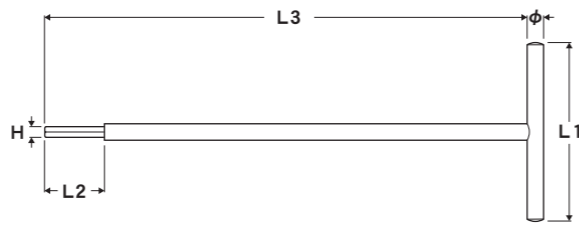

ST500-8

- Heavy duty and durable steel handle for fast and strong tightening work.
- High grade abrasion resistance and durability.
- Black finished steel handle and blade with hard chrome plated hexagon tip.

## ST-\* INDIVIDUAL

Standard length

■ SNCM+V® special ■ Hard chrome plated blade

Metric size (Hanging header)

Item No.	H	L1	L2	L3	φ	Inner	W x H x D	g
ST-2.5	2.5	80	25	190	8	10	205x95x70	1,085
ST-3	3	80	25	190	8	10	205x95x70	1,092
ST-4	4	100	35	200	8	10	225x110x80	1,205
ST-5	5	120	50	250	10	10	290x135x90	2,211
ST-6	6	160	50	250	12	10	325x177x67	3,508
ST-8	8	180	60	300	14	10	340x215x97	5,620
ST-10*	10	200	25	300	12	10	340x215x97	4,698
ST-12*	12	200	25	320	16	5	340x215x97	4,902
ST-14*	14	200	30	320	16	5	340x215x97	4,338

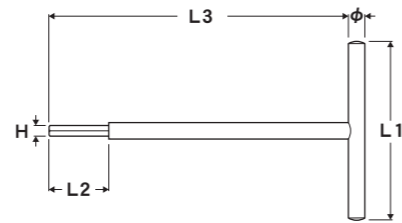

ST-8

ST-12

- The body and tip for ST-10 -14 are made of one piece and the black parkerized finish ensures durability.

# T TYPE HEXAGON WRENCH

PLASTIC HANDLE

## EXS-7 WITH STAND SET

Short length

■ SNCM+V® special ■ Hard chrome plated blade

Metric size (Paper box)

Item No.	Pcs.	H						Inner	W x H x D	g	
EXS-7	7	2	2.5	3	4	5	6	8	1	236x134x78	826



EXS-7



EXH-8  
(OLD : EX-8)

- Short length suitable for work in cramped places.
- T-type plastic handle permits easy fastening with greater power for secure tightening.
- High quality acetate plastic handle is resistant to both oil and chemicals, is extremely durable, and prevents slippage and damage from impact while being easy on the hands.

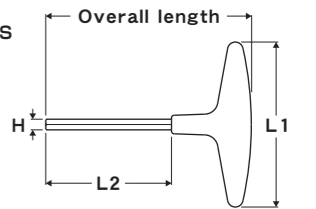

## EX-\* INDIVIDUAL

Short length

Metric size (Bulk pack)

Item No.	H	L1	L2	Overall length	Inner	W x H x D	g
EXH-2	2	85	54	94	10	165x114x73	293
EXH-2.5	2.5	85	54	94	10	165x114x73	308
EXH-3	3	85	70	110	10	165x114x73	337
EXH-4	4	100	77	127	10	196x117x78	529
EXH-5	5	100	89	139	10	196x117x78	626
EXH-6	6	125	93	153	10	196x165x89	1,055
EXH-8	8	125	95	155	10	196x165x89	1,081

※EXH has changed the item No. from EX (old).

# T TYPE "TAPER HEAD" HEXAGON WRENCH

PLASTIC HANDLE

## EXT-\* WITH SCREWDRIVER + STAND SET

■ SNCM+V® special ■ Hard chrome plated blade

Metric size (Paper box)

Item No.	Pcs.	H						Inner	W x H x D	g	
EXT-S6D	6	2.5	3	4	5	6	8	Screw Driver ⊕ No.1 × No.2	1	285x138x85	1,056



EXT-S6D

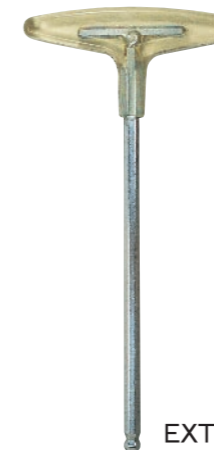

EXT-8

- High quality acetate plastic handle is resistant to both oil and chemicals, is extremely durable, and prevents slippage and damage from impact while being easy on the hands.

- Including 1 pc. Interchangeable Screwdriver Cross #1 & 2

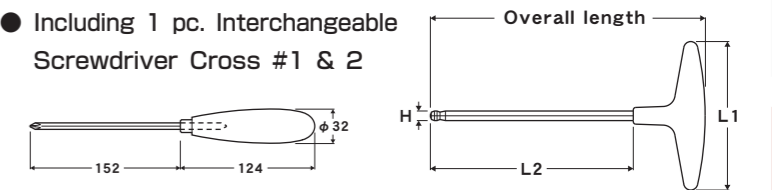

## EXT-\* INDIVIDUAL

Standard length

Metric size (Bulk pack)

Item No.	H	L1	L2	Overall length	Inner	W x H x D	g
EXT-2.5	2.5	85	110	150	10	193x95x74	332
EXT-3	3	85	126	167	10	205x95x74	379
EXT-4	4	100	130	180	10	227x110x80	596
EXT-5	5	100	153	203	10	227x110x80	739
EXT-6	6	125	170	233	10	285x138x85	1,273
EXT-8	8	125	184	245	10	285x138x85	1,763

# HEXAGON SOCKET BIT SERIES



- "EIGHT" SOCKET BIT performs well in works requiring strong forces when used with a ratchet handle or other equipment in socket wrench set.
- Our Socket Bits are produced under our original "EXCELLENT" quality standards specifying high quality material and finish to secure high strength and tough durability for professional users.



## "TAPER HEAD" HEXAGON SOCKET BIT

12.7 mm (1/2") square drive

### 21TB-S\* PLASTIC CASE SET

■ SNCM+V® special ■ Hard chrome plated blade

130mm overall length

Metric size (Plastic case)

Item No.	Drive	Pcs.	H	Outer W x H x D	g
21TB-S4	□12.7	4	5 6 8 10	20 385x203x196	9,770
21TB-S7	□12.7	7	5 6 8 10 12 14 17	10 290x217x206	12,345

※Plastic case dimensions : 21TB-S4 188x88x35mm, 21TB-S7 203 x 133 x 37mm.



21TB-S7

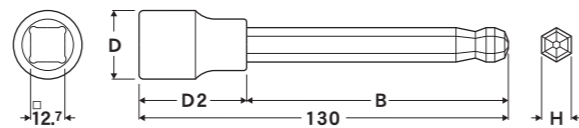

### 21TB-\* INDIVIDUAL

Metric size (Slide blister pack)

Item No.	Drive	H	D	D2	B	Inner	W x H x D	g
21TB-5	□12.7	5	23.5	33	97	10	208x158x60	887
21TB-6	□12.7	6	23.5	33	97	10	208x158x60	980
21TB-8	□12.7	8	23.5	33	97	10	208x158x60	1,234
21TB-10	□12.7	10	23.5	38	92	10	208x158x60	1,489
21TB-12	□12.7	12	23.5	38	92	10	208x158x60	1,825
21TB-14	□12.7	14	23.5	38	92	10	208x158x60	2,244
21TB-17	□12.7	17	25	41	89	10	208x158x60	3,020



21TB-14

# HEXAGON SOCKET BIT

12.7 mm (1/2") square drive

### 21LB-S\* PLASTIC CASE SET

■ SNCM+V® special ■ Hard chrome plated blade

110mm overall length

Metric size (Plastic case)

Item No.	Drive	Pcs.	H	Outer W x H x D	g
21LB-S4	□12.7	4	5 6 8 10	20 385x203x196	9,330
21LB-S7	□12.7	7	5 6 8 10 12 14 17	10 290x217x206	11,455

※Plastic case dimensions : 21LB-S4 188x88x35mm, 21LB-S7 203 x 133 x 37mm.



21LB-S7

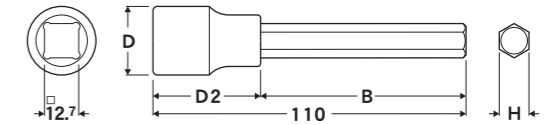

21LB-12

### 21LB-\* INDIVIDUAL

Metric size (Slide blister pack)

Item No.	Drive	H	D	D2	B	Inner	W x H x D	g
21LB-3	□12.7	3	23.5	33	77	10	209x157x60	752
21LB-4	□12.7	4	23.5	33	77	10	209x157x60	764
21LB-5	□12.7	5	23.5	33	77	10	209x157x60	869
21LB-6	□12.7	6	23.5	33	77	10	209x157x60	947
21LB-8	□12.7	8	23.5	33	77	10	209x157x60	1,157
21LB-10	□12.7	10	23.5	38	72	10	209x157x60	1,380
21LB-12	□12.7	12	23.5	38	72	10	209x157x60	1,670
21LB-14	□12.7	14	23.5	38	72	10	209x157x60	2,049
21LB-17	□12.7	17	25	41	69	10	209x157x60	2,785

### 21SB-S\* PLASTIC CASE SET

■ SNCM+V® special ■ Hard chrome plated blade

Standard length

Metric size (Plastic case)

Item No.	Drive	Pcs.	H	Outer W x H x D	g
21SB-S4	□12.7	4	5 6 8 10	20 385x203x196	7,870
21SB-S7	□12.7	7	5 6 8 10 12 14 17	10 290x217x206	9,445

※Plastic case dimensions : 21SB-S4 188x88x35mm, 21SB-S7 203 x 133 x 37mm.



21SB-S7

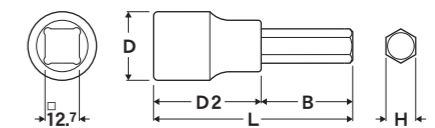

21SB-10

### 21SB-\* INDIVIDUAL

Metric size (Slide blister pack)

Item No.	Drive	H	D	D2	B	L	Inner	W x H x D	g
21SB-3	□12.7	3	23.5	33	16	49	10	174x160x70	681
21SB-4	□12.7	4	23.5	33	18	51	10	174x160x70	675
21SB-5	□12.7	5	23.5	33	21	54	10	174x160x70	721
21SB-6	□12.7	6	23.5	33	23	56	10	174x160x70	789
21SB-8	□12.7	8	23.5	33	25	58	10	174x160x70	907
21SB-10	□12.7	10	23.5	38	28	66	10	174x160x70	1,061
21SB-12	□12.7	12	23.5	38	32	70	10	174x160x70	1,248
21SB-14	□12.7	14	23.5	38	43	81	10	174x160x70	2,264
21SB-17	□12.7	17	25	41	45	86	10	174x160x70	3,020

**83TB-S\* PLASTIC CASE SET**

130mm overall length

■ SNCM+V® special ■ Hard chrome plated blade

Metric size (Plastic case)

Item No.	Drive	Pcs.	H					Outer	W x H x D	g
83TB-S5	□9.5	5	4	5	6	8	10	20	385x203x196	8,450



83TB-S5

Plastic case dimensions :  
188×88×35mm

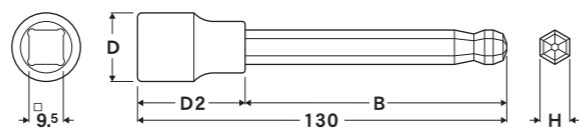

**83TB-\* INDIVIDUAL**

Metric size (Slide blister pack)

Item No.	Drive	H	D	D2	B	Inner	W x H x D	g
83TB-3	□9.5	3	17	27	103	10	210x160x60	523
83TB-4	□9.5	4	17	27	103	10	210x160x60	551
83TB-5	□9.5	5	17	27	103	10	210x160x60	611
83TB-6	□9.5	6	17	27	103	10	210x160x60	711
83TB-8	□9.5	8	17	29	101	10	210x160x60	927
83TB-10	□9.5	10	19	29	101	10	210x160x60	1,288



83TB-8

**83LB-S5 PLASTIC CASE SET**

110mm overall length

■ SNCM+V® special ■ Hard chrome plated blade

Metric size (Plastic case)

Item No.	Drive	Pcs.	H					Outer	W x H x D	g
83LB-S5	□9.5	5	4	5	6	8	10	20	385x203x196	7,890



83LB-S5

Plastic case dimensions :  
188×88×35mm

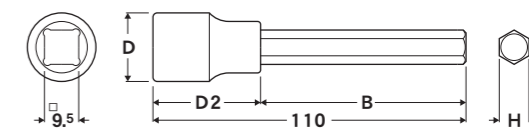

**83LB-\* INDIVIDUAL**

Metric size (Slide blister pack)

Item No.	Drive	H	D	D2	B	Inner	W x H x D	g
83LB-3	□9.5	3	17	27	83	10	210x160x60	511
83LB-4	□9.5	4	17	27	83	10	210x160x60	536
83LB-5	□9.5	5	17	27	83	10	210x160x60	597
83LB-6	□9.5	6	17	27	83	10	210x160x60	678
83LB-8	□9.5	8	17	29	81	10	210x160x60	867
83LB-10	□9.5	10	19	29	81	10	210x160x60	1,179



83LB-8

Specific production of hexagon socket bits are available.



Pictures of slide blister pack.

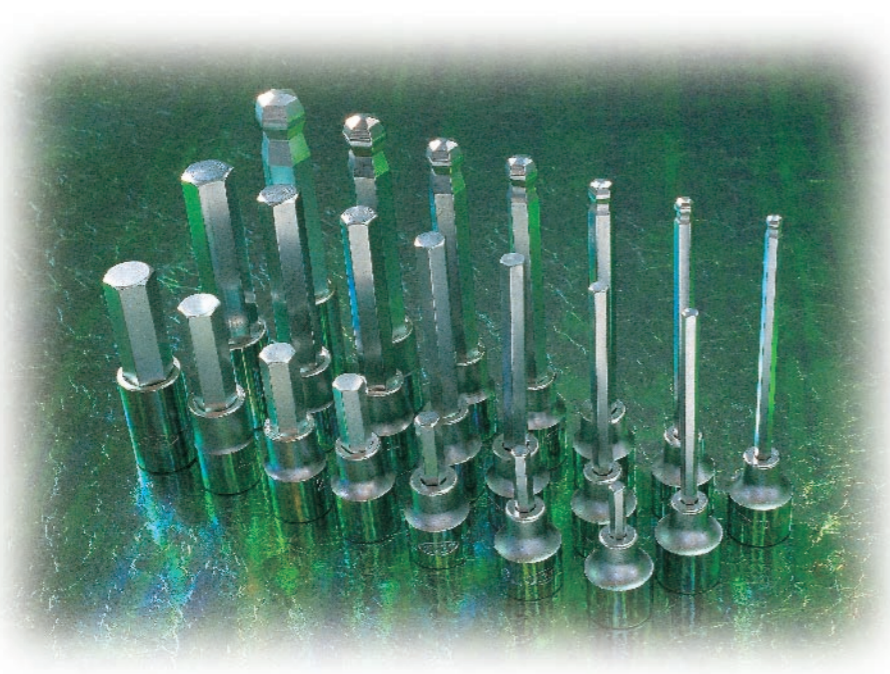

**83SB-S5 PLASTIC CASE SET**

Standard length

■ SNCM+V® special ■ Hard chrome plated blade

Metric size (Plastic case)

Item No.	Drive	Pcs.	H					Outer	W x H x D	g
83SB-S5	□9.5	5	4	5	6	8	10	20	385x203x196	6,370
			( 1.5 2 2.5 3 L type Hexagon wrench )							



83SB-S5

Plastic case dimensions :  
188×88×35mm

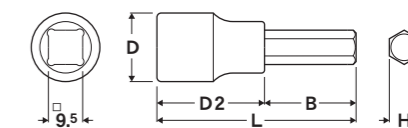

**83SB-\* INDIVIDUAL**

Metric size (Slide blister pack)

Item No.	Drive	H	D	D2	B	L	Inner	W x H x D	g
83SB-3	□9.5	3	17	27	17	44	10	140x135x55	387
83SB-4	□9.5	4	17	27	19	46	10	140x135x55	387
83SB-5	□9.5	5	17	27	22	49	10	140x135x55	417
83SB-6	□9.5	6	17	27	24	51	10	140x135x55	457
83SB-8	□9.5	8	17	29	27	56	10	140x135x55	547
83SB-10	□9.5	10	19	29	30	59	10	140x135x55	757



83SB-8

# HEXAGON BIT

12.7 mm (1/2") square drive, 8mm SHANK

## 21HB-S6 PLASTIC CASE SET

45 mm overall length bits

■ SNCM+V® special ■ Hard chrome plated bits



21HB-S6

Plastic case dimensions :  
136×67×25mm

Metric size (Plastic case)

Item No.	Drive	Pcs.	H	Inner	W x H x D	g
21HB-S6	□12.7	6	4 5 6 7 8 10 With 12.7mm (1/2") drive Bit Holder	10	350x163x75	2,372

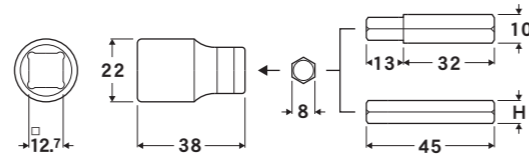

## 21HB-B\* INDIVIDUAL

Metric size (Poly bag with header)

Item No.	Overall length	H	Inner	W x H x D	g
21HB-B4	45	4	10	128x69x49	192
21HB-B5	45	5	10	128x69x49	202
21HB-B6	45	6	10	128x69x49	212
21HB-B7	45	7	10	128x69x49	222
21HB-B8	45	8	10	128x69x49	232
21HB-B10	45	10	10	128x69x49	312

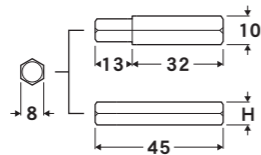

Usage example

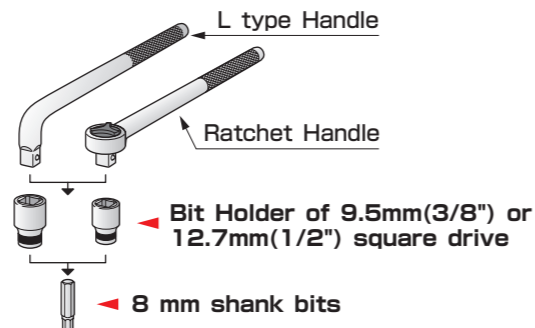

Specific production of hexagon bits are available.



21-127P



83-8

## BIT HOLDER for 8 mm shank bits

■ SCM 435 ■ Chrome plated

INDIVIDUAL (Poly bag with header)

Item No.	Inner	W x H x D	g
21-127P	10	128x69x49	642

12.7mm (1/2") sq. drive

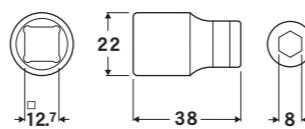

INDIVIDUAL (Poly bag with header)

Item No.	Inner	W x H x D	g
83-8	10	128x69x49	272

9.5mm (3/8") sq. drive

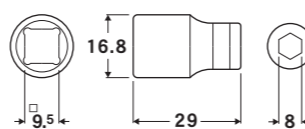

# HEXAGON SOCKET BIT

6.35 mm (1/4") square drive

## 41SB-\* PLASTIC CASE SET

Standard length

■ SNCM+V® special ■ Hard chrome plated blade



41SB-S6

Plastic case dimensions :  
100×71×20mm

Metric size (Plastic case)

Item No.	Drive	Pcs.	H	Inner	W x H x D	g
41SB-S6	□6.35	6	3 4 5 6 8 10	10	280x112x80	2,107

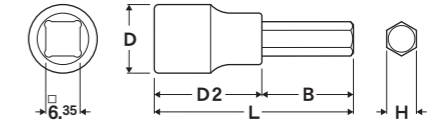

## 41SB-\* INDIVIDUAL

Standard length

Metric size (Poly bag with header)

Item No.	Drive	H	D	D2	B	L	Inner	W x H x D	g
41SB-2	□6.35	2	13	22	12	34	10	128x69x49	182
41SB-2.5	□6.35	2.5	13	22	13	35	10	128x69x49	182
41SB-3	□6.35	3	13	22	15	37	10	128x69x49	192
41SB-4	□6.35	4	13	24	16	40	10	128x69x49	222
41SB-5	□6.35	5	13	24	19	43	10	128x69x49	242
41SB-6	□6.35	6	13	24	22	46	10	128x69x49	302
41SB-8	□6.35	8	15	28	24	52	10	128x69x49	472
41SB-10	□6.35	10	15	28	28	56	10	128x69x49	552



41SB-4



# 6.35 mm (1/4") SQUARE WRENCH



## KNIFE TYPE 6.35 mm (1/4") SQUARE & TX WRENCH

■ SNCM+V® ■ Black parkerized finish

Square drive and TX wrench with bit holder (Slide blister pack)

Item No.	Pcs.	Description	Inner	W x H x D	g
SQN-635TX	4	6.35sq. wrench & bit holder & T20 T25 T27	10	210x205x90	2,579

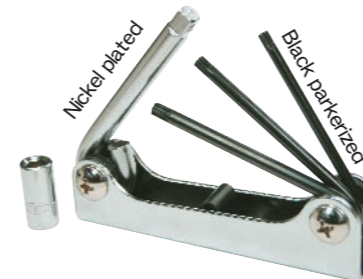

SQN-635TX

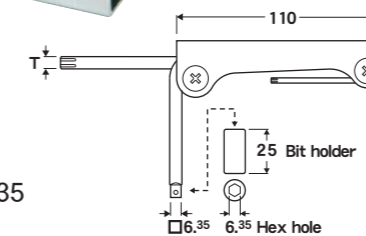

SQH-635



41-635

Usage example

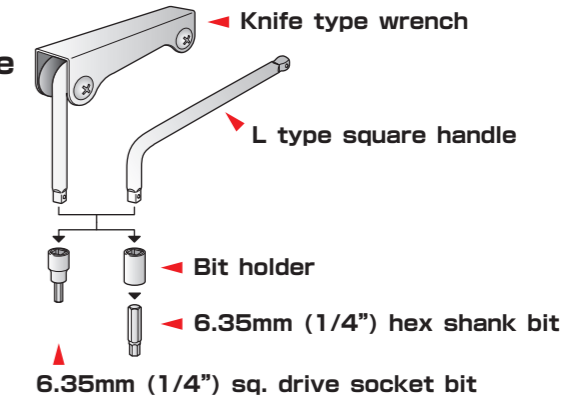

## L TYPE HANDLE 6.35 mm (1/4") SQUARE

■ SNCM ■ Nickel plated

INDIVIDUAL (Poly bag with header)

Item No.	Inner	W x H x D	g
SQH-635	10	250x90x35	750

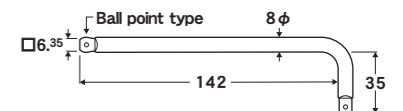

## BIT HOLDER for 6.35 mm shank bits

■ SCM 435 ■ Chrome plated

INDIVIDUAL (Poly bag with header)

Item No.	Inner	W x H x D	g
41-635	10	128x69x49	182

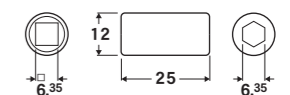

EXCELLENT SERIES

STANDARD SERIES

TX SERIES

L type

KNIFE type

SCREW DRIVER type

T type

SOCKET BIT type

BIT type

EXCELLENT SERIES

STANDARD SERIES

TX SERIES

L type

KNIFE type

SCREW DRIVER type

T type

SOCKET BIT type

BIT type

# “TAPER HEAD” HEXAGON BIT

6.35 mm SHANK FOR POWER TOOLS

## EA-64 INDIVIDUAL

75 or 100 mm length

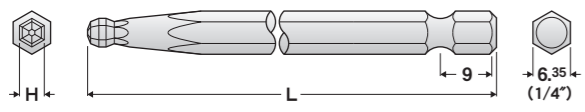

■ SNCM+V<sup>®</sup> special ■ Hard chrome plated

9 mm groove, Metric size (Bulk pack)

Item No.	Code #	H	L	Inner	W x H x D	g
EA-64 2.5mm x 75	642575	2.5	75	10	125x62x31	204
EA-64 2.5mm x 100	642510	2.5	100	10	125x62x31	264
EA-64 3mm x 75	643075	3	75	10	125x62x31	204
EA-64 3mm x 100	643010	3	100	10	125x62x31	264
EA-64 4mm x 75	644075	4	75	10	125x62x31	204
EA-64 4mm x 100	644010	4	100	10	125x62x31	264
EA-64 5mm x 75	645075	5	75	10	125x62x31	204
EA-64 5mm x 100	645010	5	100	10	125x62x31	274
EA-64 6mm x 75	646075	6	75	10	125x62x31	214
EA-64 6mm x 100	646010	6	100	10	125x62x31	274

EA-64  
2.5~6mm x 100

EA-64  
2.5~6mm x 75

## EA-70 INDIVIDUAL

130 or 160 mm length

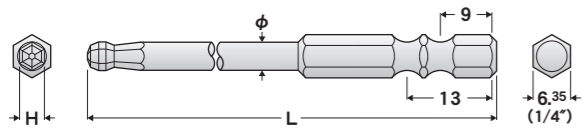

■ SNCM+V<sup>®</sup> special ■ Hard chrome plated

9 and 13 mm grooves, Metric size (Bulk pack)

Item No.	H	φ	L	Inner	W x H x D	g
EA-70 2.5mm x 130	2.5	3.1	130	10	162x70x30	163
EA-70 2.5mm x 160	2.5	3.1	160	10	200x65x30	185
EA-70 3mm x 130	3	3.4	130	10	162x70x30	187
EA-70 3mm x 160	3	3.4	160	10	200x65x30	215
EA-70 4mm x 130	4	5	130	10	162x70x30	252
EA-70 4mm x 160	4	5	160	10	200x65x30	300
EA-70 5mm x 130	5	6.2	130	10	162x70x30	329
EA-70 5mm x 160	5	6.2	160	10	200x65x30	399
EA-70 6mm x 130	6	7	130	10	162x70x30	392
EA-70 6mm x 160	6	7	160	10	200x65x30	485

EA-70  
2.5~6mm x 160

EA-70  
2.5~6mm x 130

## EA-66 INDIVIDUAL

65 or 110 mm length

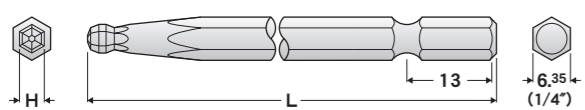

■ SNCM+V<sup>®</sup> special ■ Hard chrome plated

13 mm groove, Metric size (Bulk pack)

Item No.	Code #	H	L	Inner	W x H x D	g
EA-66 2.5mm x 65	662565	2.5	65	10	125x62x31	174
EA-66 2.5mm x 110	662511	2.5	110	10	125x62x31	294
EA-66 3mm x 65	663065	3	65	10	125x62x31	174
EA-66 3mm x 110	663011	3	110	10	125x62x31	294
EA-66 4mm x 65	664065	4	65	10	125x62x31	184
EA-66 4mm x 110	664011	4	110	10	125x62x31	294
EA-66 5mm x 65	665065	5	65	10	125x62x31	184
EA-66 5mm x 110	665011	5	110	10	125x62x31	304
EA-66 6mm x 65	666065	6	65	10	125x62x31	184
EA-66 6mm x 110	666011	6	110	10	125x62x31	304

EA-66  
2.5~6mm x 110

EA-66  
2.5~6mm x 65

# HEXAGON BIT

6.35 mm SHANK FOR POWER TOOLS

## EA-63 INDIVIDUAL

50 or 75 mm length

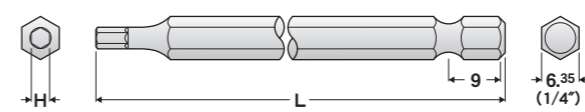

■ SNCM+V<sup>®</sup> special ■ Hard chrome plated

9 mm groove, Metric size (Bulk pack)

Item No.	Code #	H	L	Inner	W x H x D	g
EA-63 2.5mm x 50	632550	2.5	50	10	125x62x31	134
EA-63 2.5mm x 75	632575	2.5	75	10	125x62x31	194
EA-63 3mm x 50	633050	3	50	10	125x62x31	134
EA-63 3mm x 75	633075	3	75	10	125x62x31	194
EA-63 4mm x 50	634050	4	50	10	125x62x31	134
EA-63 4mm x 75	634075	4	75	10	125x62x31	204
EA-63 5mm x 50	635050	5	50	10	125x62x31	144
EA-63 5mm x 75	635075	5	75	10	125x62x31	214
EA-63 6mm x 50	636050	6	50	10	125x62x31	144
EA-63 6mm x 75	636075	6	75	10	125x62x31	214

EA-63  
2.5~6mm x 75

EA-63  
2.5~6mm x 50

## EA-65 INDIVIDUAL

65 or 110 mm length

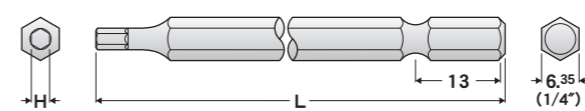

■ SNCM+V<sup>®</sup> special ■ Hard chrome plated

13 mm groove, Metric size (Bulk pack)

Item No.	Code #	H	L	Inner	W x H x D	g
EA-65 2.5mm x 65	652565	2.5	65	10	125x62x31	164
EA-65 2.5mm x 110	652511	2.5	110	10	125x62x31	294
EA-65 3mm x 65	653065	3	65	10	125x62x31	174
EA-65 3mm x 110	653011	3	110	10	125x62x31	294
EA-65 4mm x 65	654065	4	65	10	125x62x31	174
EA-65 4mm x 110	654011	4	110	10	125x62x31	294
EA-65 5mm x 65	655065	5	65	10	125x62x31	174
EA-65 5mm x 110	655011	5	110	10	125x62x31	304
EA-65 6mm x 65	656065	6	65	10	125x62x31	184
EA-65 6mm x 110	656011	6	110	10	125x62x31	304

EA-65  
2.5~6mm x 110

EA-65  
2.5~6mm x 65

Specific production of hexagon bits are available.

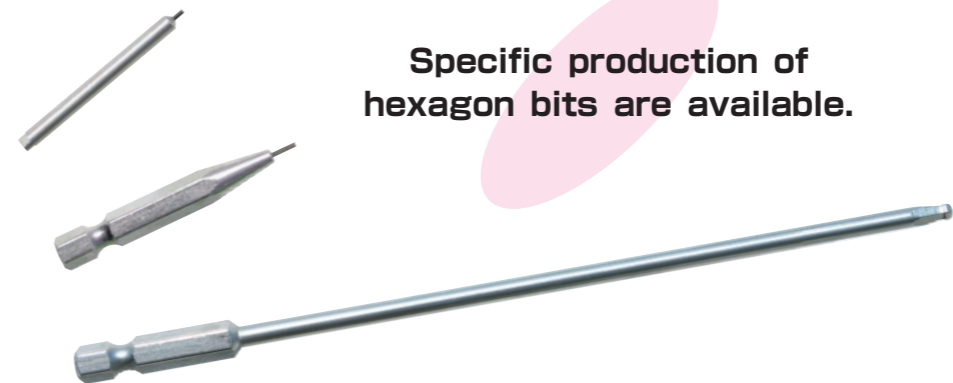

EXCELLENT SERIES

STANDARD SERIES

T X SERIES

L type

KNIFE type

SCREW DRIVER type

T type

SOCKET BIT type

BIT type

5 and 8 mm SHANK FOR POWER TOOLS

**EA-62 INDIVIDUAL**

100 mm length



■ SNCM+V<sup>®</sup> special ■ Hard chrome plated

**5 mm shank 13 mm groove, Metric size (Bulk pack)**

Item No.	Code #	H	L	Inner	W x H x D	g
EA-62 2.5mm X 100	622510	2.5	100	10	125x62x31	174
EA-62 3mm X 100	623010	3	100	10	125x62x31	174
EA-62 4mm X 100	624010	4	100	10	125x62x31	174
EA-62 5mm X 100	625010	5	100	10	125x62x31	184



EA-62  
2.5~5mm X 100

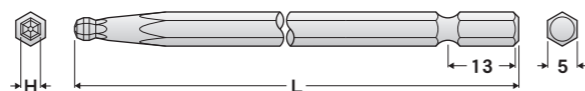

**EA-68 INDIVIDUAL**

100 mm length



■ SNCM+V<sup>®</sup> special ■ Hard chrome plated

**8 mm shank 13 mm groove, Metric size (Bulk pack)**

Item No.	Code #	H	L	Inner	W x H x D	g
EA-68 5mm X 100	680510	5	100	10	125x62x31	414
EA-68 6mm X 100	680610	6	100	10	125x62x31	414
EA-68 8mm X 100	680810	8	100	10	125x62x31	434
EA-68 10mm X 100	681010	10	100	10	125x62x31	594
EA-68 12mm X 100	681210	12	100	10	125x62x31	804



EA-68  
5~12mm X 100

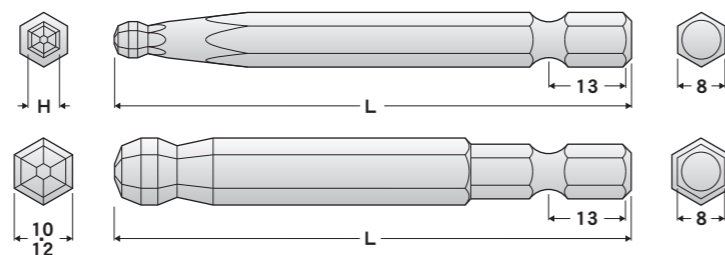

5 and 8 mm SHANK FOR POWER TOOLS

**EA-61 INDIVIDUAL**

70 mm length



■ SNCM+V<sup>®</sup> special ■ Hard chrome plated

**5 mm shank 13 mm groove, Metric size (Bulk pack)**

Item No.	Code #	H	L	Inner	W x H x D	g
EA-61 2.5mm X 70	612570	2.5	70	10	125x62x31	124
EA-61 3mm X 70	613070	3	70	10	125x62x31	124
EA-61 4mm X 70	614070	4	70	10	125x62x31	134
EA-61 5mm X 70	615070	5	70	10	125x62x31	134

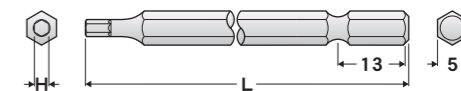

**EA-67 INDIVIDUAL**

70 mm length



■ SNCM+V<sup>®</sup> special ■ Hard chrome plated

**8 mm shank 13 mm groove, Metric size (Bulk pack)**

Item No.	Code #	H	L	Inner	W x H x D	g
EA-67 5mm X 70	670570	5	70	10	125x62x31	274
EA-67 6mm X 70	670670	6	70	10	125x62x31	284
EA-67 8mm X 70	670870	8	70	10	125x62x31	315
EA-67 10mm X 70	671070	10	70	10	125x62x31	424

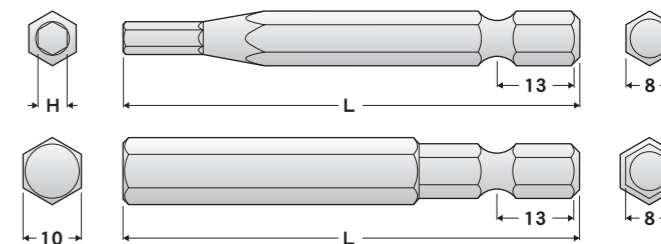



# GUARANTEED QUALITY



## STANDARD SERIES







Specifications of **EIGHT** brand Hexagon wrenches exceed the requirements of ISO, JIS, and Federal standards, especially in the categories of Material, Hardness, Torque, and Tolerance, ensuring high quality and performance to satisfy professional users.

**RAW MATERIAL :**  
**SNCM+V® = Nickel Chrome Molybdenum + Vanadium**

SNCM+V a Registered Trademark of EIGHT TOOL COMPANY and use of the same mark by any other company is legally prohibited.



## STANDARD SERIES

- L type 
- KNIFE type 
- SCREW DRIVER type 
- T type 
- SOCKET BIT type 
- BIT type 

# HEXAGON WRENCH

STANDARD LENGTH

## No.001-\* INDIVIDUAL

■ SNCM+V<sub>6</sub> ■ Black parkerized finish

### Metric size (Bulk pack)

Code #	H	L1	L2	Inner	W x H x D	g
No.001-0.71mm	0.71	8	34	100	100x80x50	50
No.001-0.89mm	0.89	10	34	100	100x80x50	58
No.001-1.27mm	1.27	14	46	100	100x80x50	96
No.001-1.4mm	1.4	11	50	100	100x80x50	110
No.001-1.5mm	1.5	12	52	100	100x80x50	128
No.001-2mm	2	12	58	100	100x80x50	219
No.001-2.5mm	2.5	15	60	100	100x80x50	345
No.001-3mm	3	20	65	100	100x80x50	542
No.001-3.5mm	3.5	22	68	100	100x80x50	774
No.001-4mm	4	25	72	100	115x85x47	1,083
No.001-4.5mm	4.5	27	76	100	115x85x47	1,449
No.001-5mm	5	28	80	100	142x95x55	1,872
No.001-5.5mm	5.5	30	85	100	142x95x55	2,426
No.001-6mm	6	32	90	100	150x124x60	3,029
No.001-7mm	7	34	95	50	142x95x55	2,209
No.001-8mm	8	36	100	50	150x124x60	3,039
No.001-9mm	9	38	106	50	158x128x62	4,059
No.001-10mm	10	40	112	30	150x124x63	3,171
No.001-11mm	11 (7/16")	42	118	25	158x128x62	3,465
No.001-12mm	12	45	125	20	158x128x62	3,467
No.001-13mm	13	50	132	10	185x124x42	2,172
No.001-14mm	14	55	140	10	185x124x42	2,687
No.001-15mm	15	57	150	10	195x130x50	3,276
No.001-16mm	16 (5/8")	57	153	10	195x130x50	3,724
No.001-17mm	17	60	160	10	205x135x50	4,455
No.001-18mm	18	65	170	6	205x114x63	3,221
No.001-19mm	19 (3/4")	70	175	6	205x114x63	3,735
No.001-20mm	20	72	185	6	240x120x77	4,376
No.001-21mm	21	75	198	6	240x120x77	5,150
No.001-22mm	22	80	200	6	240x120x77	5,800
No.001-23mm	23	85	210	-	-	-
No.001-24mm	24	90	225	-	-	-
No.001-26mm	26	95	245	-	-	-
No.001-27mm	27	100	250	-	-	-
No.001-30mm	30	120	290	-	-	-
No.001-32mm	32	125	315	-	-	-
No.001-36mm	36	130	320	-	-	-
No.001-41mm	41	140	390	-	-	-
No.001-46mm	46	155	410	-	-	-
No.001-50mm	50	170	430	-	-	-

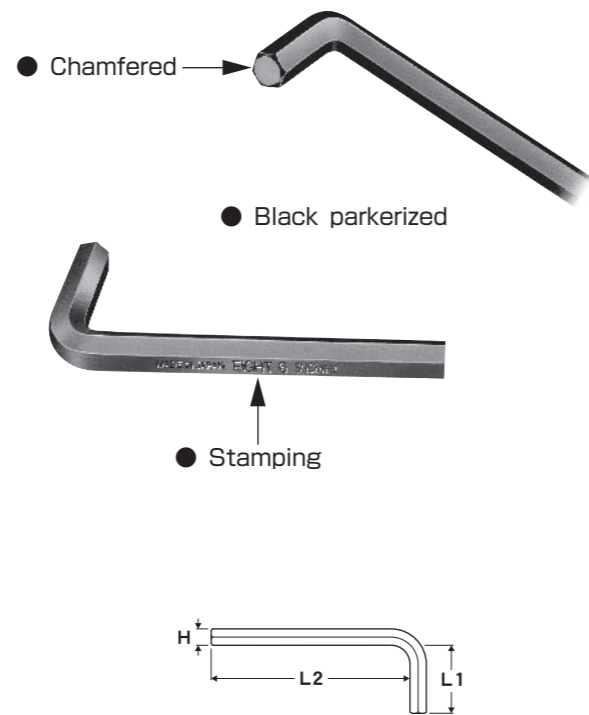

### Inch size (Bulk pack)

Code #	H	L1	L2	Inner	W x H x D	g
No.001-0.028"	0.028"	8	34	100	100x80x50	50
No.001-0.035"	0.035"	10	34	100	100x80x50	58
No.001-0.05"	0.05"	14	46	100	100x80x50	96
No.001-1/16"	1/16"	13	46	100	100x80x50	130
No.001-5/64"	5/64"	14	50	100	100x80x50	200
No.001-3/32"	3/32"	17	56	100	100x80x50	303
No.001-7/64"	7/64"	18	58	100	100x80x50	424
No.001-1/8"	1/8"	20	59.5	100	100x80x50	568
No.001-9/64"	9/64"	22	65	100	100x80x50	784
No.001-5/32"	5/32"	24	68	100	115x85x47	1,007
No.001-3/16"	3/16"	25	75	100	142x95x55	1,583
No.001-7/32"	7/32"	27	81	100	142x95x55	2,291
No.001-1/4"	1/4"	30	88	100	148x125x62	3,273
No.001-9/32"	9/32"	34	95	50	142x95x55	2,296
No.001-5/16"	5/16"	34	98	50	148x125x62	2,871
No.001-3/8"	3/8"	37	110	30	148x125x62	2,792
No.001-7/16"	7/16"	42	118	25	158x128x62	3,465
No.001-1/2"	1/2"	45	125	20	155x125x60	3,859
No.001-9/16"	9/16"	55	138	10	185x124x42	2,788
No.001-5/8"	5/8"	57	153	10	195x130x50	3,724
No.001-3/4"	3/4"	70	175	6	205x114x63	3,735
No.001-7/8"	7/8"	80	200	6	240x120x77	5,810
No.001-1"	1"	95	235	-	-	-

# HEXAGON WRENCH WITH RING

STANDARD LENGTH

## No.004-\* METAL RING SET

■ SNCM+V<sub>6</sub> ■ Black parkerized finish



No.004-3

No.004-6

### Metric and Inch size (Vinyl kit with header)

Code #	Pcs.	H	Inner	W x H x D	g
No.004-1	8	1.5 2 2.5 3 4 5 5.5 6	12	196x108x71	1,474
No.004-2	8	2 2.5 3 4 5 6 8 10	12	228x167x70	3,272
No.004-3	10	1.5 2 2.5 3 4 5 5.5 6 8 10	12	228x167x70	3,589
No.004-4	8	1/16 5/64 3/32 1/8 5/32 3/16 7/32 1/4	12	196x108x71	1,444
No.004-5	8	3/32 1/8 5/32 3/16 7/32 1/4 5/16 3/8	12	228x167x70	3,345
No.004-6	10	1/16 5/64 3/32 1/8 5/32 3/16 7/32 1/4 5/16 3/8	12	228x167x70	3,355

● This convenient wrench set is usable as a key ring.

## No.004-\* NP PLASTIC RING SET

■ SNCM+V<sub>6</sub> ■ Nickel plated



No.004-2NP

Nickel plated finish

### Metric and Inch size (Slide blister pack)

Code #	Pcs.	H	Inner	W x H x D	g
No.004-2NP	8	2 2.5 3 4 5 6 8 10	10	233x220x73	2,798
No.004-5NP	8	3/32 1/8 5/32 3/16 7/32 1/4 5/16 3/8	10	233x220x73	2,873

● The soft but tough plastic color ring keeps wrenches together and opens easily for wrench removal.

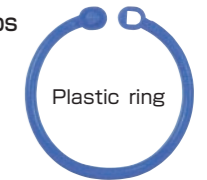

Plastic ring

# NEW BOREHOLE DOUBLE ENDS HEXAGON WRENCH

STANDARD LENGTH

## 001H-S6 DOOR HOLDER SET

■ SNCM+V<sub>6</sub> ■ Nickel plated

### Metric size (Slide blister pack)

Item No.	Pcs.	H	Inner	W x H x D	g
NEW 001H-S6	6	2 2.5 3 4 5 6	10	165x153x97	1,150



001H-S6

Specific production for special tamper-resistant screws is available.

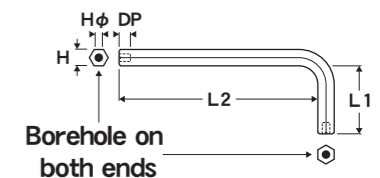

Borehole on both ends

## 001-\*H INDIVIDUAL

### Metric size (Bulk pack)

Item No.	H	L1	L2	Hφ	DP	Inner	W x H x D	g
NEW 001-2H	2	12	58	1.0	1.5	10	162x68x30	50
NEW 001-2.5H	2.5	15	60	1.3	2.0	10	162x68x30	61
NEW 001-3H	3	20	65	1.5	3.0	10	162x68x30	80
001-4H	4	25	72	2.0	3.0	10	162x68x30	132
001-5H	5	28	80	2.5	3.5	10	162x68x30	212
001-6H	6	32	90	3.2	5.0	10	162x68x30	322
001-8H	8	36	100	4.6	6.0	10	162x68x30	602
001-10H	10	40	112	5.7	7.0	10	162x68x30	1,052

※ Tamper-resistant screws are usually made under special specifications, so our products might not be suitable for all tamper-resistant screws.

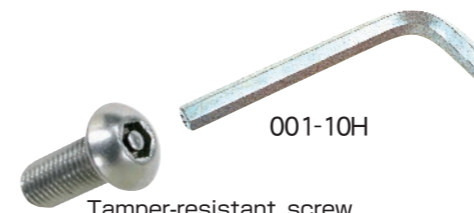

001-10H

Tamper-resistant screw

EXCELLENT SERIES

STANDARD SERIES

TX SERIES

L type

KNIFE type

SCREW DRIVER type

T type

SOCKET BIT type

BIT type

**NEW**

# HEXAGON WRENCH

STANDARD LENGTH

## 001-S12 / M-7MH PLASTIC HOLDER SET

■ SNCM+V<sub>6</sub> ■ Black parkerized finish



Metric size (Slide blister pack)

Item No.	Pcs.	H							Inner	W x H x D	g
<b>NEW</b> 001-S12	12	0.71	0.89	1.27	1.5	2	2.5	3	10	165x154x100	2,838
		4	5	6	8	10					

### ●New Double-Decker Type Holder Set

Front and back holders folded in a double-decker for compact storage.

Full set of 12 various sizes 0.71 - 10 mm. covering a wide range of usages.

Metric size (Slide blister pack)

Item No.	Pcs.	H							Inner	W x H x D	g
<b>NEW</b> M-7MH	7	0.71	0.89	1.27	1.5	2	2.5	3	20	144x144x83	612

### ●Micro-sizes Holder Set

7 pcs. set of micro-sizes 0.71 - 3 mm. Hanging type holder for easy storage.

## M-\* MICRO SIZE, VINYL POUCH SET

■ SNCM+V<sub>6</sub> ■ Black parkerized finish



Metric and Inch size (Vinyl pouch)

Item No.	Pcs.	H							Inner	W x H x D	g	
M-7M	7	0.71	0.89	1.27	1.5	2	2.5	3	20	145x110x55	420	
M-8Z	8	0.028"	0.035"	0.05"	1/16	5/64	3/32	7/64	1/8	20	145x110x55	485

## 001-\*D DOOR HOLDER SET

■ SNCM+V<sub>6</sub> ■ Black parkerized finish



Metric and Inch size (Slide blister pack)

Item No.	Pcs.	H										Inner	W x H x D	g
001-156D	7	1.5	2	2.5	3	4	5	6				10	166x155x100	1,167
001-158D	8	1.5	2	2.5	3	4	5	6	8			10	181x166x105	1,903
001-1510D	9	1.5	2	2.5	3	4	5	6	8	10		10	200x185x124	3,166
001-9ZD	9	1/16	5/64	3/32	1/8	5/32	3/16	1/4	5/16	3/8		10	200x185x124	2,998

# HEXAGON WRENCH

STANDARD LENGTH

## No.002-\* VINYL POUCH SET

■ SNCM+V<sub>6</sub> ■ Black parkerized finish



No.002-5

Metric and Inch size (Vinyl pouch)

Code #	Pcs.	H										Inner	W x H x D	g
No.002-2	8	1.5	2	2.5	3	4	5	5.5	6			12	113x113x69	1,327
No.002-3	8	2	2.5	3	4	5	6	8	10			12	144x144x86	3,060
No.002-4	10	1.5	2	2.5	3	4	5	5.5	6	8	10	12	144x144x86	3,383
No.002-5	10	1.5	2	2.5	3	4	5	6	8	10	12	6	165x166x56	2,648
No.002-11	10	1/16	5/64	3/32	1/8	5/32	3/16	7/32	1/4	5/16	3/8	12	144x144x86	3,170
No.002-12	10	1/16	5/64	3/32	1/8	5/32	3/16	7/32	5/16	3/8	1/2	6	165x166x56	2,634

## No.012-\* VINYL POUCH SET

■ SNCM+V<sub>6</sub> ■ Black parkerized finish



No.012-4

Metric size (Vinyl pouch)

Code #	Pcs.	H										Inner	W x H x D	g
No.012-3	10	2.5	3	4	5	6	8	10	12	14	17	4	210x128x95	4,720
No.012-4	8	3	4	5	6	8	10	12	14			6	227x178x75	4,338

## No.013-1 VINYL POUCH SET

■ SNCM+V<sub>6</sub> ■ Black parkerized finish

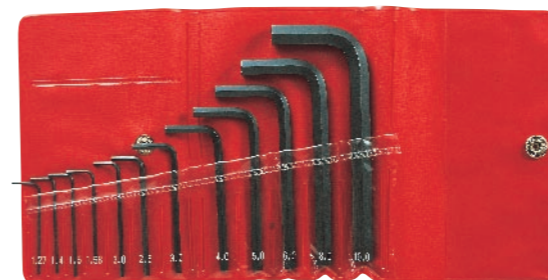

No.013-1

Metric size (Vinyl pouch)

Code #	Pcs.	H										Inner	W x H x D	g		
No.013-1	12	1.27	1.4	1.5	1.58	2	2.5	3	4	5	6	8	10	10	225x165x70	2,945

## ET-\* VINYL POUCH SET

■ SNCM+V<sub>6</sub> ■ Black parkerized finish



ET-810

Metric and Inch size (Vinyl pouch)

Item No.	Pcs.	H										Inner	W x H x D	g
ET-810	9	2	2.5	3	4	5	6	8	10	12		10	220x209x70	4,552
ET-830	8	1/8	3/16	7/32	1/4	5/16	3/8	7/16	1/2			10	220x209x70	6,055



# HEXAGON WRENCH

STANDARD LENGTH

001N-\* INDIVIDUAL

■ SNCM+V® ■ Nickel plated



No.001N-10

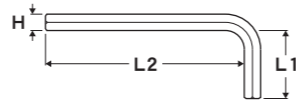

Metric size (Bulk pack)

Code #	H	L1	L2	Inner	W x H x D	g
No.001N-1.5	1.5	12	52	100	100x80x50	131
No.001N-2	2	12	58	100	100x80x50	201
No.001N-2.5	2.5	15	60	100	100x80x50	348
No.001N-3	3	20	65	100	100x80x50	545
No.001N-3.5	3.5	22	68	100	100x80x50	774
No.001N-4	4	25	72	100	115x85x47	1,081
No.001N-4.5	4.5	27	76	100	115x85x47	1,449
No.001N-5	5	28	80	100	142x95x55	1,872
No.001N-5.5	5.5	30	85	100	142x95x55	2,426
No.001N-6	6	32	90	100	150x124x60	3,037
No.001N-7	7	34	95	50	142x95x55	2,209
No.001N-8	8	36	100	50	150x124x60	3,010
No.001N-9	9	38	106	30	158x128x62	2,459
No.001N-10	10	40	112	30	150x124x63	3,171

Inch size (Bulk pack)

Code #	H	L1	L2	Inner	W x H x D	g
No.001N-1/16"	1/16"	13	46	100	100x80x50	131
No.001N-5/64"	5/64"	14	50	100	100x80x50	201
No.001N-3/32"	3/32"	17	56	100	100x80x50	308
No.001N-1/8"	1/8"	20	59.5	100	100x80x50	565
No.001N-5/32"	5/32"	24	68	100	115x85x47	1,007
No.001N-3/16"	3/16"	25	75	100	142x95x55	1,583
No.001N-7/32"	7/32"	27	81	100	142x95x55	2,064
No.001N-1/4"	1/4"	30	88	100	148x125x62	3,273
No.001N-5/16"	5/16"	34	98	50	148x125x62	2,879
No.001N-3/8"	3/8"	37	110	30	148x125x62	2,792

# HEXAGON WRENCH

LONG LENGTH

No.008-\* VINYL POUCH SET

■ SNCM+V® ■ Black parkerized finish

Metric and Inch size (Vinyl pouch)

Code #	Pcs.	H	Inner	W x H x D	g
No.008-1	9	1.5 2 2.5 3 4 5 6 8 10	10	232x183x75	3,821
No.008-2	10	1/16 5/64 3/32 1/8 5/32 3/16 7/32 1/4 5/16 3/8	10	232x183x75	3,935



No.008-1

No.008-\* INDIVIDUAL

■ SNCM+V® ■ Black parkerized finish

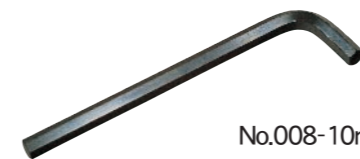

No.008-10mm

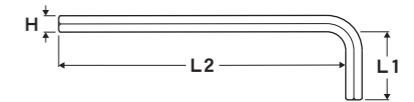

# HEXAGON WRENCH

LONG LENGTH

MC-008D MICRO SIZE PLASTIC CASE SET

■ SNCM+V® ■ Black parkerized finish



MC-008D

Plastic case dimensions : 140x70x20mm

Metric size (Plastic case)

Item No.	Pcs.	H	Inner	W x H x D	g
MC-008D	7	0.89 mm Hexagon screwdriver * hexagon : 1.27 1.5 2 2.5 3 4	10	180x165x105	963

- Precision Hexagon wrenches set suitable for various hobbies.
- Packed in plastic case for easy carrying.

008-\* D DOOR HOLDER SET

■ SNCM+V® ■ Black parkerized finish



008-156D

Metric size (Slide blister pack)

Item No.	Pcs.	H	Inner	W x H x D	g
008-156D	7	1.5 2 2.5 3 4 5 6	10	150x200x98	1,485
008-158D	8	1.5 2 2.5 3 4 5 6 8	5	235x92x103	1,265

- Easy operation and innovative design of hexagon wrench holder.

Metric size (Bulk pack)

Code #	H	L1	L2	Inner	W x H x D	g
No.008-1.5mm	1.5	16	79	100	100x80x50	173
No.008-2mm *	2	17	86	100	115x85x48	308
No.008-2.5mm	2.5	18	94	100	115x85x48	501
No.008-3mm *	3	20	101	100	144x95x55	774
No.008-4mm *	4	25	110	100	144x95x55	1,491
No.008-5mm	5	28	120	100	190x100x55	2,547
No.008-5.5mm	5.5	30	127	100	205x115x64	3,297
No.008-6mm	6	32	133	100	205x115x64	4,056
No.008-7mm *	7	34	145	50	205x115x64	3,058
No.008-8mm	8	36	154	50	205x115x64	4,180
No.008-9mm *	9	38	163	25	205x115x64	2,858
No.008-10mm	10	40	172	25	302x89x33	3,689
No.008-12mm	12	45	206	10	300x90x33	2,550
No.008-14mm	14	55	225	6	300x90x33	2,322
No.008-17mm	17	60	250	4	349x102x40	2,561
No.008-19mm	19(3/4")	70	280	4	349x102x40	3,557
No.008-21mm	21	80	310	-	-	-
No.008-22mm	22	85	325	-	-	-
No.008-24mm	24	90	346	-	-	-
No.008-26mm	26	100	366	-	-	-
No.008-27mm	27	100	375	-	-	-

Inch size (Bulk pack)

Code #	H	L1	L2	Inner	W x H x D	g
No.008-1/16"	1/16"	15	79	100	100x80x50	187
No.008-5/64"	5/64"	17	84	100	115x85x48	308
No.008-3/32"	3/32"	17	92	100	115x85x48	437
No.008-7/64"	7/64"	19	97	100	115x85x48	633
No.008-1/8"	1/8"	20	102	100	140x95x54	838
No.008-9/64"	9/64"	23	104	100	140x95x54	1,138
No.008-5/32"	5/32"	25	108	100	140x95x54	1,439
No.008-3/16"	3/16"	28	118	100	190x100x55	2,313
No.008-7/32"	7/32"	30	125	100	205x115x64	3,320
No.008-1/4"	1/4"	32	135	100	205x115x64	4,579
No.008-5/16"	5/16"	36	152	50	205x115x64	4,050
No.008-3/8"	3/8"	40	170	25	205x115x64	3,309
No.008-7/16"	7/16"	42	185	10	250x90x35	1,971
No.008-1/2"	1/2"	45	206	10	302x89x33	2,830
No.008-9/16"	9/16"	55	223	6	302x89x33	2,400
No.008-5/8"	5/8"	60	250	4	349x102x40	2,245
No.008-3/4"	3/4"	70	280	4	349x102x40	3,557
No.008-7/8"	7/8"	85	325	-	-	-
No.008-1"	1"	90	346	-	-	-

※Be sure to describe the suffix "mm" for each code number when ordering.

# HEXAGON WRENCH

EXTRA LONG LENGTH

## No.014-\* VARIOUS SETS

■ SNCM+V® ■ Black parkerized finish

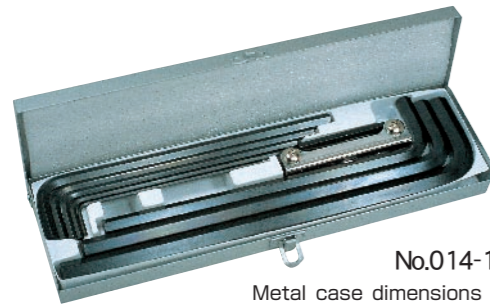

No.014-1  
Metal case dimensions :  
306×86×30mm

### METAL CASE SET

Metric and Inch size (Metal case)

Code #	Pcs.	H	Outer	W x H x D	g
No.014-1	15	( 1.5 2 2.5 3 4 5 6 KNIFE type ) 3 4 5 6 8 10 12 14	10	320x193x178	17,650
No.014-2	15	( 1/16 5/64 3/32 1/8 5/32 3/16 7/32 KNIFE type ) 1/8 5/32 3/16 1/4 5/16 3/8 1/2 9/16	10	320x193x178	16,750

- Tough metal case can be used as tool box.



No.014-3

### VINYL POUCH SET

Metric and Inch size (Vinyl pouch)

Code #	Pcs.	H	Inner	W x H x D	g
No.014-3	7	3 4 5 5.5 6 8 10	5	300x152x54	2,452
No.014-4	7	1/8 5/32 3/16 7/32 1/4 5/16 3/8	5	300x152x54	2,351

### FLAT TYPE HOLDER SET

Metric size (Slide blister pack)

Code #	Pcs.	H	Inner	W x H x D	g
No.014-9	9	1.5 2 2.5 3 4 5 6 8 10	5	310x120x60	2,335

- Plastic holder enables easy storage and removal of wrenches, and offers secure storage and handy carrying.



No.014-9

### DOOR HOLDER SET

Metric size (Slide blister pack)

Item No.	Pcs.	H	Inner	W x H x D	g
014-156D	7	1.5 2 2.5 3 4 5 6	10	255x153x89	1,763
014-158D	8	1.5 2 2.5 3 4 5 6 8	5	281x92x99	1,508

- Easy operation and innovative design of hexagon wrench holder.



014-156D

# HEXAGON WRENCH

EXTRA LONG LENGTH

## No.014-\* INDIVIDUAL

■ SNCM+V® ■ Black parkerized finish

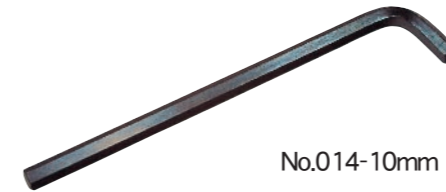

No.014-10mm

### Metric size (Bulk pack)

Code #	H	L1	L2	Inner	W x H x D	g
No.014-1.5mm	1.5	16	79	20	163x68x32	41
No.014-2mm	2	17	95	20	163x68x32	90
No.014-2.5mm	2.5	18	110	20	163x68x32	137
No.014-3mm	3	20	126	20	163x68x32	206
No.014-4mm	4	25	142	20	163x68x32	390
No.014-5mm	5	28	160	20	203x65x30	663
No.014-5.5mm	5.5	30	170	20	203x65x30	864
No.014-6mm	6	32	180	20	225x75x29	1,066
No.014-7mm	7	34	190	10	225x75x29	791
No.014-8mm	8	36	200	10	225x75x29	1,061
No.014-9mm	9	38	220	10	250x90x35	1,461
No.014-10mm	10	40	224	10	250x90x35	1,841
No.014-11mm	11 (7/16")	43	240	4	275x77x31	1,012
No.014-12mm	12	45	250	4	275x77x31	1,216
No.014-14mm	14	55	280	4	302x89x33	1,856
No.014-17mm	17	60	320	4	349x102x40	3,090
No.014-19mm	19 (3/4")	70	360	4	413x95x45	4,349

※Be sure to describe the suffix "mm" for each code number when ordering.

### Inch size (Bulk pack)

Code #	H	L1	L2	Inner	W x H x D	g
No.014-1/16"	1/16"	15	79	20	163x68x32	61
No.014-5/64"	5/64"	17	93	20	163x68x32	81
No.014-3/32"	3/32"	18	108	20	163x68x32	121
No.014-1/8"	1/8"	20	127	20	163x68x32	221
No.014-5/32"	5/32"	25	140	20	163x68x32	361
No.014-3/16"	3/16"	28	158	20	203x65x30	524
No.014-7/32"	7/32"	30	168	20	203x65x30	864
No.014-1/4"	1/4"	32	178	20	225x75x29	1,184
No.014-9/32"	9/32"	34	188	10	225x75x29	811
No.014-5/16"	5/16"	36	198	10	225x75x29	1,031
No.014-3/8"	3/8"	40	222	10	250x90x35	1,661
No.014-7/16"	7/16"	43	240	4	275x77x31	1,003
No.014-1/2"	1/2"	45	248	4	275x77x31	1,339
No.014-9/16"	9/16"	55	278	4	302x89x33	1,916
No.014-5/8"	5/8"	60	320	4	349x102x40	2,712
No.014-3/4"	3/4"	70	360	4	413x95x45	4,349

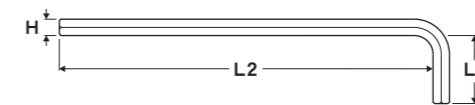

EXCELLENT SERIES

STANDARD SERIES

TX SERIES

L type

KNIFE type

SCREW DRIVER type

T type

SOCKET BIT type

BIT type

EXCELLENT SERIES

STANDARD SERIES

TX SERIES

L type

KNIFE type

SCREW DRIVER type

T type

SOCKET BIT type

BIT type

EXCELLENT SERIES

STANDARD SERIES

TX SERIES

L type

KNIFE type

SCREW DRIVER type

T type

SOCKET BIT type

BIT type

EXCELLENT SERIES

STANDARD SERIES

TX SERIES

L type

KNIFE type

SCREW DRIVER type

T type

SOCKET BIT type

BIT type

EXCELLENT SERIES

STANDARD SERIES

TX SERIES

L type

KNIFE type

SCREW DRIVER type

T type

SOCKET BIT type

BIT type

EXCELLENT SERIES

STANDARD SERIES

TX SERIES

L type

KNIFE type

SCREW DRIVER type

T type

SOCKET BIT type

BIT type

EXCELLENT SERIES

STANDARD SERIES

TX SERIES

L type

KNIFE type

SCREW DRIVER type

T type

SOCKET BIT type

BIT type

EXCELLENT SERIES

STANDARD SERIES

TX SERIES

L type

KNIFE type

SCREW DRIVER type

T type

SOCKET BIT type

BIT type

EXCELLENT SERIES

STANDARD SERIES

TX SERIES

L type

KNIFE type

SCREW DRIVER type

T type

SOCKET BIT type

BIT type

EXCELLENT SERIES

STANDARD SERIES

TX SERIES

L type

KNIFE type

SCREW DRIVER type

T type

SOCKET BIT type

BIT type

EXCELLENT SERIES

STANDARD SERIES

TX SERIES

L type

KNIFE type

SCREW DRIVER type

T type

SOCKET BIT type

BIT type

EXCELLENT SERIES

STANDARD SERIES

TX SERIES

L type

KNIFE type

SCREW DRIVER type

T type

SOCKET BIT type

BIT type

EXCELLENT SERIES

STANDARD SERIES

TX SERIES

L type

KNIFE type

SCREW DRIVER type

T type

SOCKET BIT type

BIT type

EXCELLENT SERIES

STANDARD SERIES

TX SERIES

L type

KNIFE type

SCREW DRIVER type

T type

SOCKET BIT type

BIT type

EXCELLENT SERIES

STANDARD SERIES

TX SERIES

L type

KNIFE type

SCREW DRIVER type

T type

SOCKET BIT type

BIT type

EXCELLENT SERIES

STANDARD SERIES

TX SERIES

L type

KNIFE type

SCREW DRIVER type

T type

SOCKET BIT type

BIT type

EXCELLENT SERIES

STANDARD SERIES

TX SERIES

L type

KNIFE type

SCREW DRIVER type

T type

SOCKET BIT type

BIT type

EXCELLENT SERIES

STANDARD SERIES

TX SERIES

L type

KNIFE type

SCREW DRIVER type

T type

SOCKET BIT type

# BALL POINT HEXAGON WRENCH

LONG LENGTH

## MC-016D MICRO SIZE PLASTIC CASE SET

■ SNCM+V® ■ Black parkerized finish

Metric size (Plastic case)

Item No.	Pcs.	H	Inner	W x H x D	g
MC-016D	7	0.89 mm Hexagon screwdriver* hexagon : 1.27 1.5 2 2.5 3 4	10	180x165x105	963



MC-016D  
Plastic case dimensions :  
140x70x20mm

- Precision Hexagon wrenches set suitable for various hobbies.
- Packed in plastic case for easy carrying.

## 016-\*D DOOR HOLDER SET

■ SNCM+V® ■ Black parkerized finish

Metric and Inch size (Slide blister pack)

Item No.	Pcs.	H	Inner	W x H x D	g
016-158D	8	1.5 2 2.5 3 4 5 6 8	5	233x94x100	1,256
016-1510D	9	1.5 2 2.5 3 4 5 6 8 10	5	258x104x122	2,097
016-13ZD	13	0.05" 1/16 5/64 3/32 7/64 1/8 9/64 5/32 3/16 7/32 1/4 5/16 3/8	5	255x115x133	2,418



016-1510D

- "BALL POINT" enables fast pre-fastening.
- Angle can be inclined up to 25 degrees.
- Ball point shape ensures easy insertion into screw hole.



**BALL POINT**

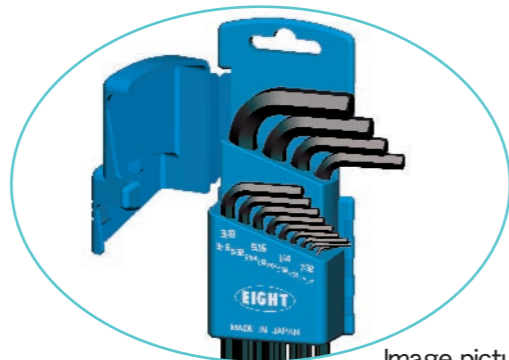

Image picture :  
016-13ZD

# BALL POINT HEXAGON WRENCH

LONG LENGTH

## No.016-\* INDIVIDUAL

■ SNCM+V® ■ Black parkerized finish

Metric size (Slide blister pack)

Code #	H	L1	L2	Inner	W x H x D	g
No.016-1.27mm	1.27 (0.05")	14	75	10	170x69x50	129
No.016-1.5mm	1.5	16	79	10	170x69x50	128
No.016-2mm*	2	17	86	10	170x69x50	145
No.016-2.5mm	2.5	18	94	10	170x69x50	161
No.016-3mm*	3	20	101	10	170x69x50	187
No.016-4mm*	4	25	110	10	170x69x50	255
No.016-5mm	5	28	120	10	213x90x62	428
No.016-5.5mm	5.5	30	127	10	213x90x62	507
No.016-6mm	6	32	133	10	213x90x62	577
No.016-8mm	8	36	154	10	270x135x78	1,097
No.016-10mm	10	40	172	10	270x135x78	1,702
No.016-12mm*	12	45	206	10	300x90x33	2,500
No.016-14mm*	14	55	225	6	300x90x33	2,292
No.016-17mm*	17	60	250	4	349x102x40	2,513
No.016-19mm*	19 (3/4")	70	280	4	349x102x40	3,505
No.016-22mm*	22	85	325	-	-	-

※Be sure to describe the suffix "mm" for each code number when ordering.  
※Bulk pack for the sizes from 12 to 22 mm.



No.016-4mm



No.016-10mm



No.016-6mm

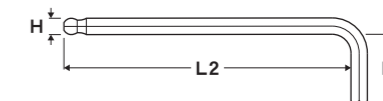

Inch size (Slide blister pack)

Code #	H	L1	L2	Inner	W x H x D	g
No.016-0.05"	0.05"(1.27)	14	75	10	170x69x50	129
No.016-1/16"	1/16"	15	79	10	170x69x50	139
No.016-5/64"	5/64"	17	84	10	170x69x50	149
No.016-3/32"	3/32"	17	92	10	170x69x50	169
No.016-7/64"	7/64"	19	97	10	170x69x50	179
No.016-1/8"	1/8"	20	102	10	170x69x50	209
No.016-9/64"	9/64"	23	104	10	170x69x50	229
No.016-5/32"	5/32"	25	108	10	170x69x50	369
No.016-3/16"	3/16"	28	118	10	213x90x65	403
No.016-7/32"	7/32"	30	125	10	213x90x65	497
No.016-1/4"	1/4"	32	135	10	213x90x65	629
No.016-5/16"	5/16"	36	152	10	270x135x78	1,080
No.016-3/8"	3/8"	40	170	10	270x135x78	1,570

EXCELLENT SERIES

STANDARD SERIES

T X SERIES

L type

KNIFE type

SCREW DRIVER type

T type

SOCKET BIT type

BIT type

# KNIFE TYPE HEXAGON WRENCH

## No.009-\* STEEL CONTAINER SET

■ SNCM+V® ■ Black parkerized finish blades

Metric size (Slide blister pack)

Code #	Pcs.	H								C	Inner	W x H x D	g
No.009-1	7	1.5	2	2.5	3	4	5	6	6	93	10	178x160x54	1,482
No.009-2	6	2.5	3	4	5	6	8			110	10	214x196x64	2,590
No.009-3	6	3	4	5	6	8	10			110	10	235x185x80	3,460
No.009-8	7	2.5	3	4	5	6	8	10		133	10	235x205x81	4,071



No.009-1

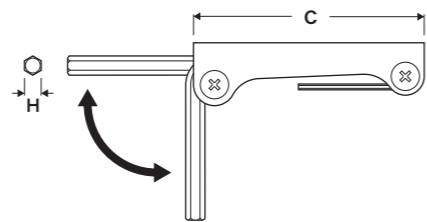

Inch size (Slide blister pack)

Code #	Pcs.	H								C	Inner	W x H x D	g
No.009-4	7	1/16	5/64	3/32	1/8	5/32	3/16	7/32		93	10	178x160x54	1,439

- All Hexagon wrenches fold into steel container for easy carrying.
- The steel container doubles as a handle to help fasten screws tightly.
- Can incline to any suitable angle.
- Black parkerized finish for the hexagon blades and chrome plated steel container.

## 009-\*N PLASTIC COVER METAL CONTAINER SET

■ SNCM+V® ■ Black parkerized finish blades

- Plastic-covered metal container is easy on the hands for comfortable operation.
- Hard steel plates applied to container frame ensure high durability against torque and tight fastening.

Metric and Inch size (Slide blister pack)

Item No.	Pcs.	H								C	Inner	W x H x D	g
009-1N	7	1.5	2	2.5	3	4	5	6	6	105	10	200x170x72	1,694
009-2N	6	2.5	3	4	5	6	8			125	10	227x197x80	2,797
009-3N	6	3	4	5	6	8	10			125	10	227x197x80	3,596
009-4N	7	1/16	5/64	3/32	1/8	5/32	3/16	7/32		105	10	200x170x72	1,656



009-1N



009-4N

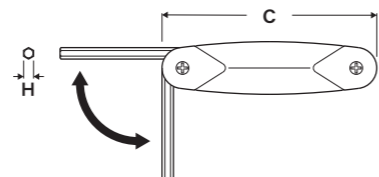

- Angle of each blade can be adjusted for fastening and pre-fastening by pulling away from or pushing toward the container.

# ALL NEW CROSS TYPE "TAPER HEAD" & HEX COMBINATION WRENCH

## SYU-W\* PLASTIC HANDLE INDIVIDUAL

■ SNCM+V® ■ Nickel plated finish blades

Metric size (Hanging header)

Item No.	Pcs.	H				W	L	Inner	W x H x D	g
SYU-W34	4	3	4	•••	Hexagon	90	22	10	155x112x100	511
		3	4	•••	Taper Head					
SYU-W56	4	5	6	•••	Hexagon	100	27	10	155x112x100	738
		5	6	•••	Taper Head					



SYU-W34

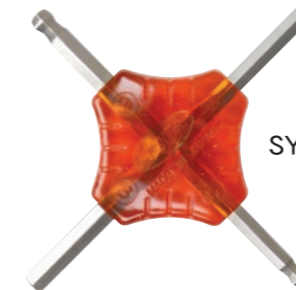

SYU-W56

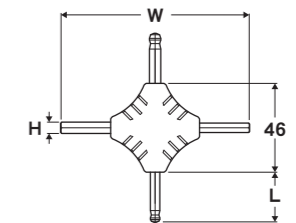

- Easy operation for pre-fastening and tight fastening by combining Taper Head Wrenches and Hexagon wrenches.
- High quality acetate plastic handle is resistant to both oil and chemicals, is extremely durable, and prevents slippage and damage from impact while being easy on the hands.

# KNIFE TYPE "TAPER HEAD" & HEX COMBINATION WRENCH

## NHT-1 / NHP-1 PLASTIC COVER METAL CONTAINER SET

■ SNCM+V® ■ Nickel plated finish blades

Metric size (Slide blister pack)

Item No.	Pcs.	H						C	Inner	W x H x D	g
NHT-1	8	( 2.5 3 4 Hexagon )		( 2.5 3 4 5 6 Taper Head )				105	10	200x170x72	1,895
NHP-1	7	2.5	3	4	5	6		105	10	200x170x72	1,831
		⊕No.1 ⊕No.2		Cross Point Screwdriver							



NHT-1

Nickel plated finish blades

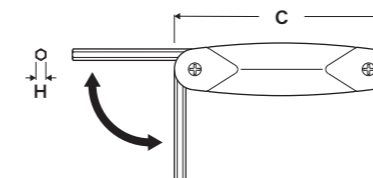

- **NHT-1:** Easy operation for pre-fastening and tight fastening by combining Taper Head Wrenches and Hexagon wrenches.

- **NHP-1:** Wider application with Cross point screwdriver blades.

# BALL POINT SCREWDRIVER with plastic handle

ORANGE COLOR

## BDS-6 VINYL POUCH SET

■ SNCM+V® ■ Black parkerized finish blade



BDS-6

Metric size (Vinyl pouch)

Item No.	Pcs.	H						Inner	W x H x D	g
BDS-6	6	1.5	2	2.5	3	4	5	5	245x160x82	1,349

- High quality acetate plastic handle is resistant to both oil and chemicals, is extremely durable, and prevents slippage and damage from impact while being easy on the hands.
- "BALL POINT" enables fast pre-fastening.
- Angle can be inclined up to 25 degrees.
- Ball point shape offers positive engagement and high degree of workability.

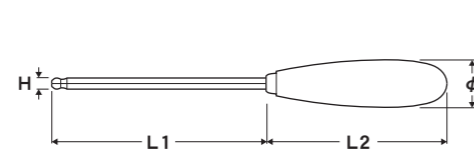

**BALL POINT**

## BD-\* INDIVIDUAL

Metric size (Plastic hanger)

Item No.	H	L1	L2	φ	Inner	W x H x D	g
BD-1.5	1.5	65	69	18	20	173x100x58	425
BD-2	2	70	69	18	20	173x100x58	448
BD-2.5	2.5	75	84	22	20	198x115x62	715
BD-3	3	80	84	22	20	198x115x62	767
BD-4	4	90	99	26	10	233x137x35	648
BD-5	5	100	99	26	10	233x137x35	745
BD-6	6	110	122	32	10	272x163x43	1,277



Plastic hanger

BD-6

# NEW HEXAGON SCREWDRIVER with plastic handle

ROCKET TYPE

## RR-S6 FREE COMBINATION, MICRO SIZE SET

■ SNCM+V® ■ Black parkerized finish blade



RR-S6

Metric size (Slide blister pack)

Item No.	Pcs.	H						Inner	W x H x D	g
RR-S6	6	0.71	0.89	1.27	1.5	1.59(1/16)	2(5/64)	12	179x123x47	207

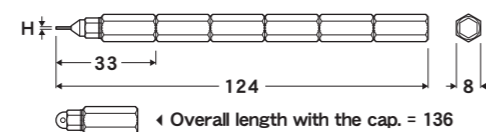

← Overall length with the cap. = 136

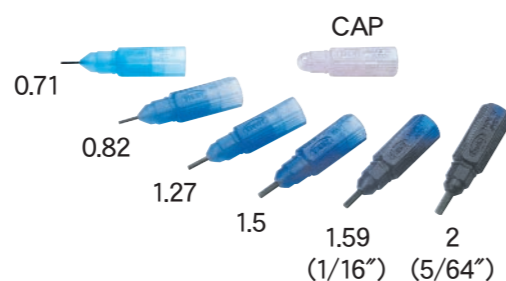

(1/16") (5/64")



# NEW HEXAGON SCREWDRIVER with plastic handle

RED & BLUE COLOR

## HFD-\* FLAG TYPE SCREWDRIVER - INDIVIDUAL

■ SNCM+V® ■ Black parkerized finish blade

Metric size (Poly bag with header)

Item No.	H	L1	L2	Overall length	Inner	W x H x D	g
NEW HFD-1.5	1.5	18	10	110	10	200x70x58	128
NEW HFD-2	2	20	12	112	10	200x70x58	136
NEW HFD-2.5	2.5	22	14	114	10	200x70x58	146
NEW HFD-3	3	26	16	116	10	200x70x58	162

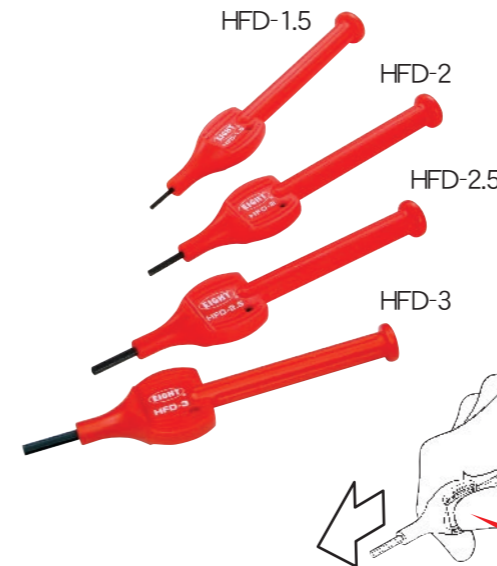

HFD-1.5

HFD-2

HFD-2.5

HFD-3

**New attractive design !**

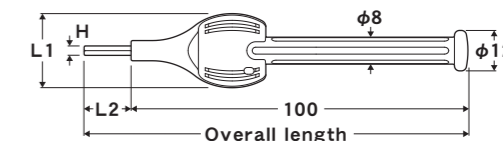

Easy one-hand operation for firm screw driving without coming off, insured by the finger stopper and the handle fitting to the palm.

## No.006-3 VINYL POUCH SET

■ SNCM+V® ■ Black parkerized finish blade

Metric size (Vinyl pouch)

Code #	Pcs.	H						Inner	W x H x D	g
No.006-3	6	2	2.5	3	4	5	6	6	250x137x74	1,725



No.006-3

- High quality acetate plastic handle is resistant to both oil and chemicals, is extremely durable, and prevents slippage and damage from impact while being easy on the hands.

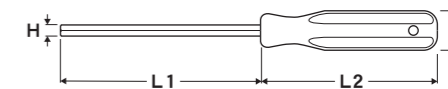

## No.006-\* INDIVIDUAL

Metric size (Bulk pack)

Code #	H	L1	L2	φ	Inner	W x H x D	g
No.006-1.5mm	1.5	65	70	13	20	155x70x29	270
No.006-2mm*	2	70	70	13	20	155x70x29	300
No.006-2.5mm	2.5	75	78	16	20	165x85x42	460
No.006-3mm*	3	80	78	16	20	165x85x42	510
No.006-4mm	4	100	94	20	10	207x100x31	505
No.006-5mm	5	100	94	20	10	207x100x31	585
No.006-6mm	6	110	110	24	10	230x117x33	905

※Be sure to describe the suffix "mm" for each code number when ordering.



No.006-6mm



# T TYPE HEXAGON WRENCH Plastic handle

LONG LENGTH

## 018L-\*H INDIVIDUAL

■ SNCM+V® ■ Nickel plated blade

**LONG LENGTH BLADE ADAPTED FOR USE IN THE DEEP SPACE !**

Metric size (Hanging header)

Item No.	H	L1	L2	Overall length	Inner	W x H x D	g
018L-2H	2	85	200	240	10	284x95x72	384
018L-2.5H	2.5	85	200	240	10	284x95x72	423
018L-3H	3	85	300	340	10	384x95x72	558
018L-4H	4	100	300	350	10	397x110x78	859
018L-5H	5	100	350	400	10	450x110x78	1,165
018L-6H	6	125	350	410	10	470x135x88	1,804
018L-8H	8	200	350	430	10	490x215x97	3,522
018L-10H	10	200	350	430	10	490x215x97	4,273

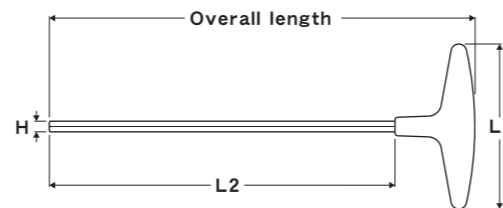

Inch size (Hanging header)

Item No.	H	L1	L2	Overall length	Inner	W x H x D	g
018L-5/64H	5/64"	85	200	240	10	284x95x72	381
018L-3/32H	3/32"	85	200	240	10	284x95x72	411
018L-1/8H	1/8"	85	300	340	10	382x95x74	580
018L-5/32H	5/32"	100	300	350	10	400x112x113	846
018L-3/16H	3/16"	100	350	400	10	400x112x113	1,082
018L-1/4H	1/4"	125	350	410	10	490x137x82	1,916
018L-5/16H	5/16"	200	350	430	10	490x215x97	3,547
018L-3/8H	3/8"	200	350	430	10	490x215x97	4,307

- High quality acetate plastic handle is resistant to both oil and chemicals, is extremely durable, and prevents slippage and damage from impact while being easy on the hands.
- 1.5 times longer than the standard length.
- Printed header for hanging display.



# NEW T TYPE HEXAGON WRENCH Plastic handle

SHORT LENGTH

## 018S-\*H INDIVIDUAL

■ SNCM+V® ■ Nickel plated blade

Metric size (Hanging header)

Item No.	H	L1	L2	Overall length	Inner	W x H x D	g
018S-2H	2	85	54	94	10	162x113x65	323
018S-2.5H	2.5	85	54	94	10	162x113x65	333
018S-3H	3	85	70	110	10	162x113x65	363
018S-4H	4	100	77	127	10	162x113x65	553
018S-5H	5	100	89	139	10	193x115x75	659
018S-6H	6	125	93	153	10	180x134x85	1,090

- Short length suitable for work in cramped places.
- T-type plastic handle permits easy fastening with greater power for secure tightening.

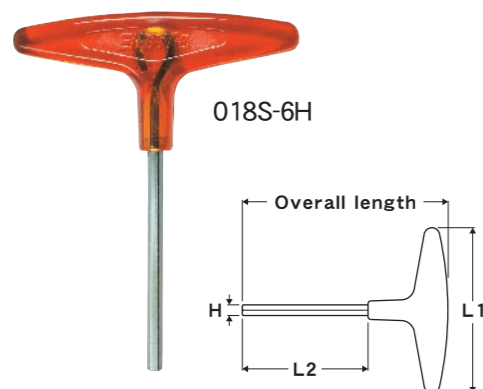

# T TYPE HEXAGON WRENCH Plastic handle

STANDARD LENGTH

## No.018-\* HEXAGON WRENCH SET

■ SNCM+V® ■ Nickel plated blade



No.018-1



No.018-2

Metric and Inch size (Slide blister pack)

Code #	Pcs.	H						Inner	W x H x D	g
No.018-1	5	2.5	3	4	5	6	5	345x240x90	2,057	
No.018-2	5	3/32	1/8	5/32	3/16	1/4	5	345x240x90	2,069	

- High quality acetate plastic handle is resistant to both oil and chemicals, is extremely durable, and prevents slippage and damage from impact while being easy on the hands.

## 018-\*H INDIVIDUAL

Metric size (Hanging header)

Item No.	H	L1	L2	Overall length	Inner	W x H x D	g
018-2H	2	85	71	110	10	190x83x62	316
018-2.5H	2.5	85	110	150	10	195x97x77	358
018-3H	3	85	126	167	10	202x98x77	405
018-4H	4	100	130	180	10	227x112x80	620
018-5H	5	100	153	203	10	254x112x79	773
018-6H	6	125	173	233	10	292x137x89	1,313
018-8H	8	200	184	264	10	310x212x92	2,728
018-10H	10	200	204	284	10	342x217x94	3,380

Inch size (Hanging header)

Item No.	H	L1	L2	Overall length	Inner	W x H x D	g
018-5/64H	5/64"	85	71	110	10	190x82x60	314
018-3/32H	3/32"	85	110	150	10	193x95x72	356
018-1/8H	1/8"	85	128	168	10	205x95x72	418
018-5/32H	5/32"	100	130	180	10	227x110x79	621
018-3/16H	3/16"	100	153	203	10	257x110x79	744
018-7/32H	7/32"	125	160	220	10	293x137x82	1,197
018-1/4H	1/4"	125	173	233	10	293x137x82	1,255

- Item numbers without a suffix "H" served without printed header as "Bulk packed".



# “TAPER HEAD” GRIP HANDLE HEXAGON WRENCH

PLASTIC HANDLE

PTT-\* INDIVIDUAL

■ SNCM+V® ■ Black parkerized blade

Metric size (Bulk pack)

Item No.	H	L1	L2	Overall length	Inner	W x H x D	g
PTT-2.5	2.5	75	101	123	10	153x80x60	200
PTT-3	3	75	118	140	10	232x103x64	252
PTT-4	4	92	134	161	10	232x103x64	412
PTT-5	5	92	147	174	10	300x127x77	595
PTT-6	6	119	168	202	10	300x127x77	945
PTT-8	8	119	187	221	10	300x127x77	1,425



PTT-8



“TAPER HEAD”

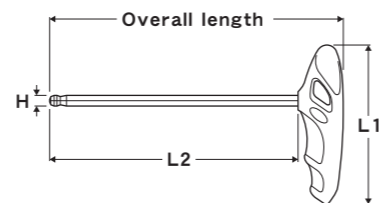

# GRIP HANDLE HEXAGON WRENCH

PLASTIC HANDLE

PTH-\* INDIVIDUAL

■ SNCM+V® ■ Black parkerized blade

Metric size (Bulk pack)

Item No.	H	L1	L2	Overall length	Inner	W x H x D	g
PTH-2	2	75	86	108	10	153x80x60	200
PTH-2.5	2.5	75	101	123	10	153x80x60	200
PTH-3	3	75	118	140	10	232x103x64	252
PTH-4	4	92	134	161	10	232x103x64	412
PTH-5	5	92	147	174	10	300x127x77	595
PTH-6	6	119	168	202	10	300x127x77	945
PTH-8	8	119	187	221	10	300x127x77	1,425



PTH-8

● Grip type plastic handle equipped with thumb rest.

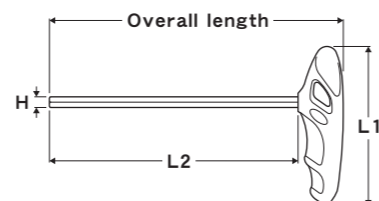

# “TAPER HEAD” HEXAGON WRENCH

EXTRA LONG LENGTH

TA14-\* D DOOR HOLDER SET

■ SNCM+V® ■ Black parkerized

Metric size (Slide blister pack)

Item No.	Pcs.	H								Inner	W x H x D	g	
TA14-1510D	9	1.5	2	2.5	3	4	5	6	8	10	5	322x104x110	2,541



TA14-1510D



“TAPER HEAD”

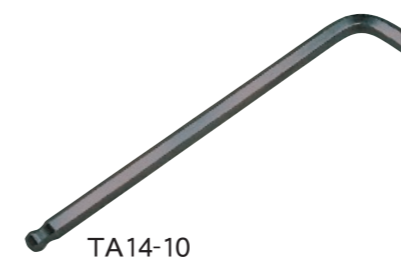

TA14-10

TA14-\* INDIVIDUAL

Metric size (Bulk pack)

Item No.	H	L1	L2	Inner	W x H x D	g
TA14-1.5	1.5	16	79	20	163x68x32	41
TA14-2	2	17	95	20	163x68x32	81
TA14-2.5	2.5	18	110	20	163x68x32	121
TA14-3	3	20	126	20	163x68x32	201
TA14-4	4	25	142	20	163x68x32	381
TA14-5	5	28	160	20	203x65x30	663
TA14-6	6	32	180	20	225x75x29	1,066
TA14-8	8	36	200	10	225x75x29	1,051
TA14-10	10	40	224	10	250x90x35	1,811

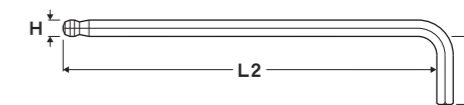

**21LB-B\* INDIVIDUAL**

110mm overall length

■ SNCM+V® ■ Black parkerized finished blade

Metric size (Poly bag with header)

Item No.	Drive	H	D	D2	B	Inner	W x H x D	g
21LB-B3	□12.7	3	23.5	33	77	10	140x95x55	598
21LB-B4	□12.7	4	23.5	33	77	10	140x95x55	608
21LB-B5	□12.7	5	23.5	33	77	10	140x95x55	708
21LB-B6	□12.7	6	23.5	33	77	10	140x95x55	788
21LB-B8	□12.7	8	23.5	33	77	10	140x95x55	998
21LB-B10	□12.7	10	23.5	38	72	10	140x95x55	1,218
21LB-B12	□12.7	12	23.5	38	72	10	140x95x55	1,508
21LB-B14	□12.7	14	23.5	38	72	10	140x95x55	1,888
21LB-B17	□12.7	17	25	41	69	10	140x95x55	2,628



21LB-B12

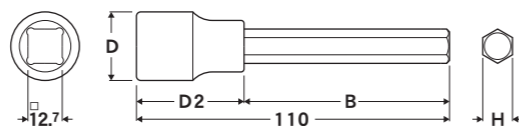

**83LB-B\* INDIVIDUAL**

110mm overall length

■ SNCM+V® ■ Black parkerized finished blade

Metric size (Poly bag with header)

Item No.	Drive	H	D	D2	B	Inner	W x H x D	g
83LB-B3	□9.5	3	17	27	83	10	125x63x45	328
83LB-B4	□9.5	4	17	27	83	10	125x63x45	330
83LB-B5	□9.5	5	17	27	83	10	125x63x45	418
83LB-B6	□9.5	6	17	27	83	10	125x63x45	488
83LB-B8	□9.5	8	17	29	81	10	125x63x45	678
83LB-B10	□9.5	10	19	29	81	10	125x63x45	1,008



83LB-B8

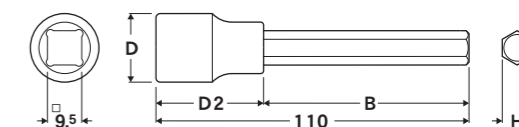

**21SB-B\* INDIVIDUAL**

Standard length

■ SNCM+V® ■ Black parkerized finished blade

Metric size (Poly bag with header)

Item No.	Drive	H	D	D2	B	L	Inner	W x H x D	g
21SB-B3	□12.7	3	23.5	33	16	49	10	115x85x50	545
21SB-B4	□12.7	4	23.5	33	18	51	10	115x85x50	545
21SB-B5	□12.7	5	23.5	33	21	54	10	115x85x50	585
21SB-B6	□12.7	6	23.5	33	23	56	10	115x85x50	655
21SB-B8	□12.7	8	23.5	33	25	58	10	115x85x50	775
21SB-B10	□12.7	10	23.5	38	28	66	10	115x85x50	925
21SB-B12	□12.7	12	23.5	38	32	70	10	115x85x50	1,105
21SB-B14	□12.7	14	23.5	38	43	81	10	140x95x55	1,478
21SB-B17	□12.7	17	25	41	45	86	10	140x95x55	2,098



21SB-B10

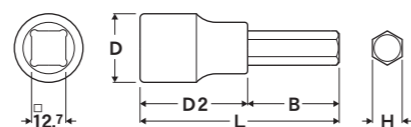

**83SB-B\* INDIVIDUAL**

Standard length

■ SNCM+V® ■ Black parkerized finished blade

Metric size (Poly bag with header)

Item No.	Drive	H	D	D2	B	L	Inner	W x H x D	g
83SB-B3	□9.5	3	17	27	17	44	10	100x80x50	303
83SB-B4	□9.5	4	17	27	19	46	10	100x80x50	303
83SB-B5	□9.5	5	17	27	22	49	10	100x80x50	333
83SB-B6	□9.5	6	17	27	24	51	10	100x80x50	373
83SB-B8	□9.5	8	17	29	27	56	10	100x80x50	463
83SB-B10	□9.5	10	19	29	30	59	10	100x80x50	673



83SB-B8

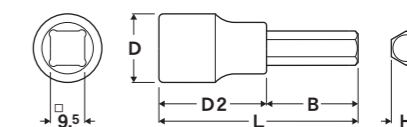

# CROSS POINT SCREWDRIVER BIT

6.35 mm SHANK FOR POWER TOOLS

## EA-01 GS\* 10 PCS. SET

■ SNCM+V® special ■ Gold color plated



EA-01 GS ⊕No.2×65

13 mm groove (Slide blister pack)

Item No.	Code #	Pcs.	⊕	L	Inner	W x H x D	g
EA-01 GS ⊕No.2×45	01GS2045	10	No.2	45	10	175x148x102	1,138
EA-01 GS ⊕No.2×65	01GS2065	10	No.2	65	10	175x148x102	1,708
EA-01 GS ⊕No.2×110	01GS2110	10	No.2	110	10	180x165x105	2,900

- 6.35mm (1/4") shank.
- Double ends screwdriver bit.
- Gold color plated finish.
- Magnetized bits.
- Plastic holder with belt clip.

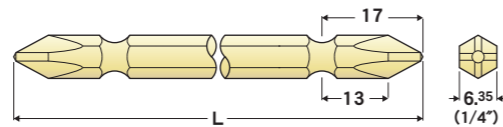
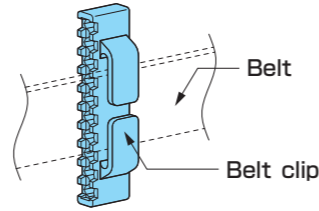

## EA-01 \* 10 PCS. SET

■ SNCM+V® special

Gold color plated Magnetized bits.



EA-01 G ⊕No.2×65



EA01 G  
⊕No.2×150  
Vinyl kit  
with header

13 mm groove (Blister pack)

Item No.	Code #	Pcs.	⊕	L	Inner	W x H x D	g
EA-01 G ⊕No.1×45	01G1045	10	No.1	45	10	172x120x41	960
EA-01 G ⊕No.1×65	01G1065	10	No.1	65	10	172x120x41	1,500
EA-01 G ⊕No.2×45	01G2045	10	No.2	45	10	172x120x41	950
EA-01 G ⊕No.2×65	01G2065	10	No.2	65	10	172x120x41	1,500
EA-01 G ⊕No.2×75	01G2075	10	No.2	75	10	172x120x41	1,730
EA-01 G ⊕No.2×110	01G2110	10	No.2	110	10	179x165x44	2,807
EA-01 G ⊕No.2×150*	01G2150	10	No.2	150	5	165x100x42	1,958
EA-01 G ⊕No.3×45	01G3045	10	No.3	45	10	172x120x41	980
EA-01 G ⊕No.3×65	01G3065	10	No.3	65	10	172x120x41	1,520
EA-01 G ⊕No.3×110	01G3110	10	No.3	110	10	179x165x44	2,777
EA-01 G ⊕No.3×150*	01G3150	10	No.3	150	5	165x100x42	2,008

※Vinyl kit with header packing for 150 mm products

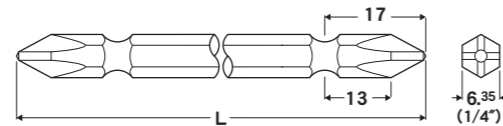

13 mm groove (Blister pack)

Item No.	Code #	Pcs.	⊕	L	Inner	W x H x D	g
EA-01 ⊕No.1×45	011045	10	No.1	45	10	172x120x41	960
EA-01 ⊕No.1×65	011065	10	No.1	65	10	172x120x41	1,500
EA-01 ⊕No.2×45	012045	10	No.2	45	10	172x120x41	950
EA-01 ⊕No.2×65	012065	10	No.2	65	10	172x120x41	1,500
EA-01 ⊕No.2×75	012075	10	No.2	75	10	172x120x41	1,730
EA-01 ⊕No.2×110	012110	10	No.2	110	10	179x165x44	2,807
EA-01 ⊕No.2×150*	012150	10	No.2	150	5	165x100x42	1,958
EA-01 ⊕No.3×45	013045	10	No.3	45	10	172x120x41	980
EA-01 ⊕No.3×65	013065	10	No.3	65	10	172x120x41	1,520
EA-01 ⊕No.3×110	013110	10	No.3	110	10	179x165x44	2,777
EA-01 ⊕No.3×150*	013150	10	No.3	150	5	165x100x42	2,008

※Vinyl kit with header packing for 150 mm products

EA-01 ⊕No.2×150  
Vinyl kit with header

EA-01 ⊕No.2×65

# CROSS POINT SCREWDRIVER BIT

6.35 mm SHANK FOR POWER TOOLS

## EA-02\* 10 PCS. SET

■ SNCM+V® special



EA-02 G ⊕No.2×75

Gold color plated Magnetized bits.



EA-02 G  
⊕No.2×150  
Vinyl kit  
with header

9 mm groove (Blister pack)

Item No.	Code #	Pcs.	⊕	L	Inner	W x H x D	g
EA-02 G ⊕No.1×75	02G1075	10	No.1	75	10	172x120x41	1,780
EA-02 G ⊕No.2×50	02G2050	10	No.2	50	10	172x120x41	1,160
EA-02 G ⊕No.2×75	02G2075	10	No.2	75	10	172x120x41	1,700
EA-02 G ⊕No.2×100	02G2100	10	No.2	100	10	179x165x44	2,517
EA-02 G ⊕No.2×150*	02G2150	10	No.2	150	5	165x100x42	1,988
EA-02 G ⊕No.3×75	02G3075	10	No.3	75	10	172x120x41	1,860
EA-02 G ⊕No.3×100	02G3100	10	No.3	100	10	179x165x44	2,607
EA-02 G ⊕No.3×150*	02G3150	10	No.3	150	5	165x100x42	2,013

※Vinyl kit with header packing for 150 mm products

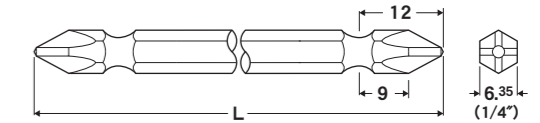

9 mm groove (Blister pack)

Item No.	Code #	Pcs.	⊕	L	Inner	W x H x D	g
EA-02 ⊕No.1×75	021075	10	No.1	75	10	172x120x41	1,780
EA-02 ⊕No.2×50	022050	10	No.2	50	10	172x120x41	1,160
EA-02 ⊕No.2×75	022075	10	No.2	75	10	172x120x41	1,700
EA-02 ⊕No.2×100	022100	10	No.2	100	10	179x165x44	2,517
EA-02 ⊕No.2×150*	022150	10	No.2	150	5	165x100x42	1,988
EA-02 ⊕No.3×75	023075	10	No.3	75	10	172x120x41	1,860
EA-02 ⊕No.3×100	023100	10	No.3	100	10	179x165x44	2,607
EA-02 ⊕No.3×150*	023150	10	No.3	150	5	165x100x42	2,013

※Vinyl kit with header packing for 150 mm products

## EA-03\* 10 PCS. SET

■ SNCM+V® special

Blister pack

Gold color plated Magnetized bits.



EA-03 G ⊕No.2×75



EA-03 G  
⊕No.2×100

9 mm groove (Blister pack)

Item No.	Code #	Pcs.	⊕	L	Inner	W x H x D	g
EA-03 G ⊕No.1×50	03G1050	10	No.1	50	10	172x120x41	1,280
EA-03 G ⊕No.1×75	03G1075	10	No.1	75	10	172x120x41	1,930
EA-03 G ⊕No.2×50	03G2050	10	No.2	50	10	172x120x41	1,280
EA-03 G ⊕No.2×75	03G2075	10	No.2	75	10	172x120x41	1,910
EA-03 G ⊕No.2×100	03G2100	10	No.2	100	10	179x165x44	2,677

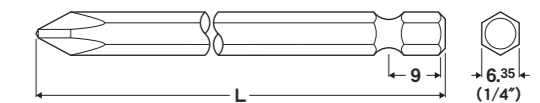

9 mm groove (Blister pack)

Item No.	Code #	Pcs.	⊕	L	Inner	W x H x D	g
EA-03 ⊕No.1×50	031050	10	No.1	50	10	172x120x41	1,280
EA-03 ⊕No.1×75	031075	10	No.1	75	10	172x120x41	1,930
EA-03 ⊕No.2×50	032050	10	No.2	50	10	172x120x41	1,280
EA-03 ⊕No.2×75	032075	10	No.2	75	10	172x120x41	1,910
EA-03 ⊕No.2×100	032100	10	No.2	100	10	179x165x44	2,660

EA-03 ⊕No.2×100

EA-03 ⊕No.2×75

**EA-05 \* SET**



■ SNCM+V® special



Gold color plated  
**13Pcs.**  
Magnetized bits.

EA-05 GS  
⊕No.2×70

**13 mm groove (Blister pack)**

Item No.	Code #	Pcs.	⊕	L	Inner	W x H x D	g
<b>NEW</b> EA-05 GS ⊕No.1×70	05GS1070	13	No.1	70	5	172x120x41	710
<b>NEW</b> EA-05 GS ⊕No.1×100	05GS1100	13	No.1	100	5	179x165x44	1,087
<b>NEW</b> EA-05 GS ⊕No.2×70	05GS2070	13	No.2	70	5	172x120x41	720
<b>NEW</b> EA-05 GS ⊕No.2×100	05GS2100	13	No.2	100	5	179x165x44	1,092
<b>NEW</b> EA-05 GS ⊕No.2×150*	05GS2150	13	No.2	150	5	165x100x42	1,643

\*Vinyl kit with header packing for 150 mm products

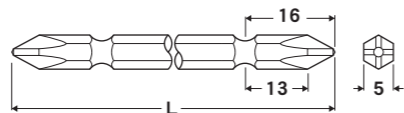

Shot finish  
**10Pcs.**



EA-05  
⊕No.2×70

**13 mm groove (Paper bag)**

Item No.	Code #	Pcs.	⊕	L	Inner	W x H x D	g
EA-05 ⊕No.1×70	051070	10	No.1	70	5	150x100x37	548
EA-05 ⊕No.1×100	051100	10	No.1	100	5	150x100x50	560
EA-05 ⊕No.2×70	052070	10	No.2	70	5	150x100x37	548
EA-05 ⊕No.2×100	052100	10	No.2	100	5	150x100x50	810
EA-05 ⊕No.2×150*	052150	10	No.2	150	5	165x100x42	1,303

\*Vinyl kit with header packing for 150 mm products

**EA-04 \* SET**



■ SNCM+V® special



Gold color plated  
**8Pcs.**  
Magnetized bits.

EA-04 GS  
⊕No.3×110

**13 mm groove (Blister pack)**

Item No.	Code #	Pcs.	⊕	L	Inner	W x H x D	g
<b>NEW</b> EA-04 GS ⊕No.2×65	04GS2065	8	No.2	65	5	172x120x41	920
<b>NEW</b> EA-04 GS ⊕No.2×110	04GS2110	8	No.2	110	5	179x165x44	1,722
<b>NEW</b> EA-04 GS ⊕No.3×65	04GS3065	8	No.3	65	5	172x120x41	920
<b>NEW</b> EA-04 GS ⊕No.3×110	04GS3110	8	No.3	110	5	179x165x44	1,737



Shot finish  
**10Pcs.**



EA-04  
⊕No.3×110

**13 mm groove (Paper bag)**

Item No.	Code #	Pcs.	⊕	L	Inner	W x H x D	g
EA-04 ⊕No.2×65	042065	10	No.2	65	5	150x100x37	1,103
EA-04 ⊕No.2×110	042110	10	No.2	110	5	150x100x50	2,047
EA-04 ⊕No.3×65	043065	10	No.3	65	5	150x100x37	1,113
EA-04 ⊕No.3×110	043110	10	No.3	110	5	150x100x50	1,717

**EA-06 \* 10 PCS. SET**



■ SNCM+V® special ■ Black parkerized finish



EA-06  
⊕No.2×80

**IMPACT DRIVER BIT 8 mm shank (Paper bag)**

Item No.	Code #	Pcs.	⊕	L	Inner	W x H x D	g
EA-06 ⊕No.2×36	062036	10	No.2	36	5	150x100x37	662
EA-06 ⊕No.2×80	062080	10	No.2	80	5	150x100x50	1,602
EA-06 ⊕No.2×125	062125	10	No.2	125	5	150x100x50	2,563
EA-06 ⊕No.3×36	063036	10	No.3	36	5	150x100x37	678
EA-06 ⊕No.3×80	063080	10	No.3	80	5	150x100x50	1,602
EA-06 ⊕No.3×125	063125	10	No.3	125	5	150x100x50	2,571

● Heavy duty screwdriver bit for Impact Wrench or Shock Driver.

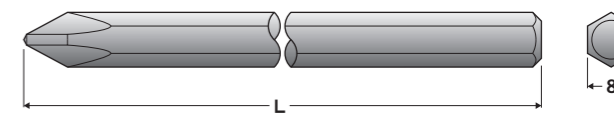

**Usage example**

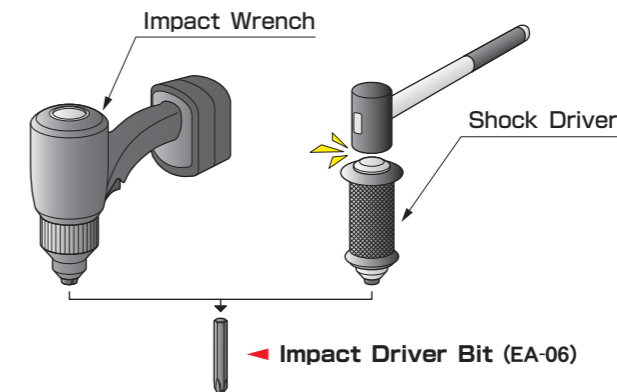

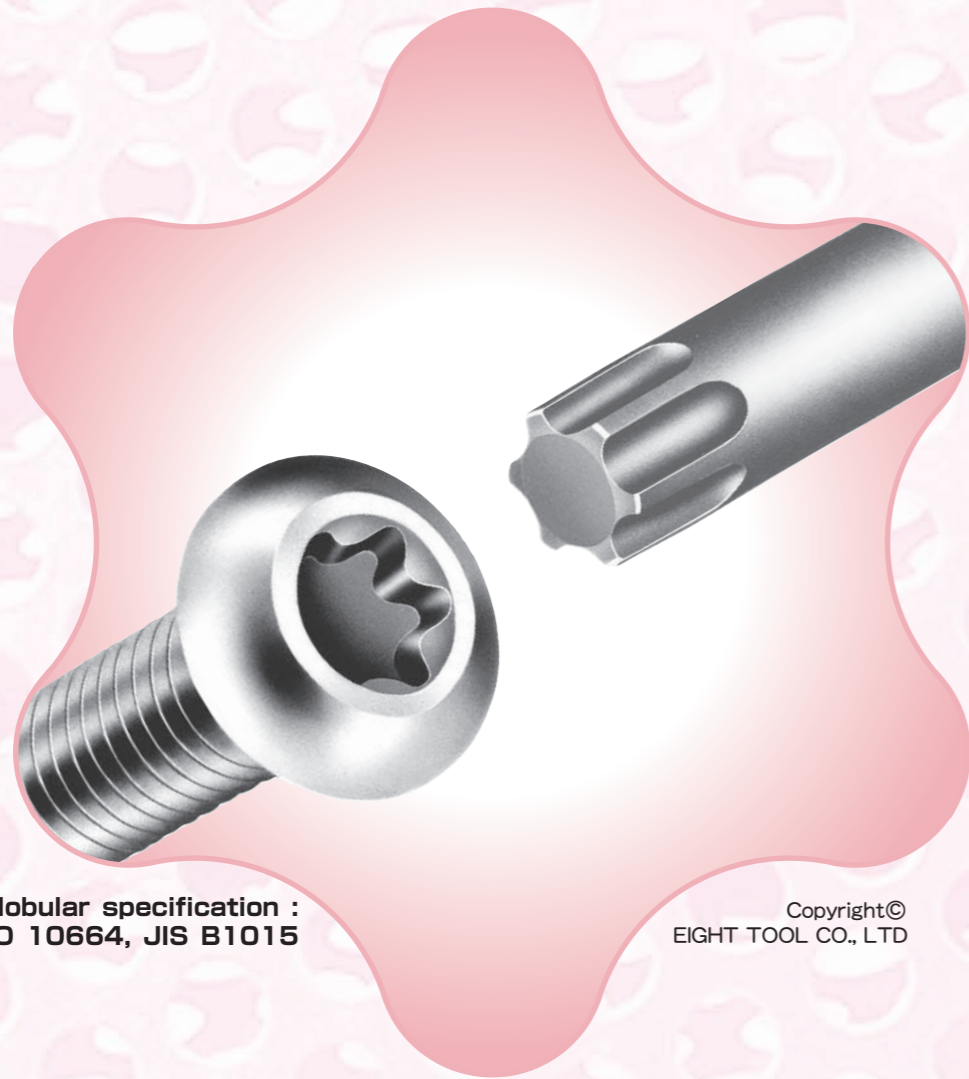

Hexalobular specification :  
ISO 10664, JIS B1015







Copyright©  
EIGHT TOOL CO., LTD

**EIGHT** BRAND **“TX”** WRENCHES are produced under the specifications of **ISO 10664, JIS B1015** "Hexalobular Internal Driving Feature" to be adapted to drive Torx screws produced under specification of Acument Global Technologies.



## “TX” SERIES



- L type 
- KNIFE type 
- SCREW DRIVER type 
- T type 
- SOCKET BIT type 
- BIT type 

# BOREHOLE & NORMAL "TX" BIT

6.35 mm SHANK FOR POWER TOOLS

## EA-34\* BOREHOLE - INDIVIDUAL

■ SNCM+V<sup>®</sup> special ■ Hard chrome plated

9 and 13 mm grooves (Bulk pack)

Item No.	T	φ	L	Hφ	DP	Inner	W x H x D	g
EA-34 T8×75	T8	3	75	0.8	0.9	10	128x60x29	121
EA-34 T8×115	T8	3	115	0.8	0.9	10	128x60x29	141
EA-34 T10×75	T10	3.6	75	1.0	1.4	10	128x60x29	131
EA-34 T10×115	T10	3.6	115	1.0	1.4	10	128x60x29	161
EA-34 T15×75	T15	4.2	75	1.3	1.6	10	128x60x29	141
EA-34 T15×115	T15	4.2	115	1.3	1.6	10	128x60x29	181
EA-34 T20×75	T20	4.8	75	1.8	2.0	10	128x60x29	151
EA-34 T20×115	T20	4.8	115	1.8	2.0	10	128x60x29	211
EA-34 T25×75	T25	5.4	75	2.1	2.2	10	128x60x29	171
EA-34 T25×115	T25	5.4	115	2.1	2.2	10	128x60x29	261
EA-34 T27×75	T27	5.9	75	2.4	2.4	10	128x60x29	181
EA-34 T27×115	T27	5.9	115	2.4	2.4	10	128x60x29	271
EA-34 T30×75	T30	6.1	75	2.7	2.9	10	128x60x29	191
EA-34 T30×115	T30	6.1	115	2.7	2.9	10	128x60x29	281
EA-34 T40×75	T40	7	75	3.2	3.4	10	128x60x29	211
EA-34 T40×115	T40	7	115	3.2	3.4	10	128x60x29	331

※Tamper-resistant screws are usually made under special specifications, so our products might not be suitable for all tamper-resistant screws.

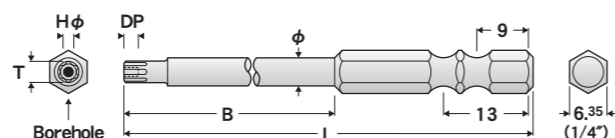

EA34  
T8~40×75



EA34  
T8~40×115

## EA-33\* NORMAL TX - INDIVIDUAL

■ SNCM+V<sup>®</sup> special ■ Hard chrome plated

9 and 13 mm grooves (Bulk pack)

Item No.	T	L	Inner	W x H x D	g
EA-33 T8×75	T8	75	10	128x60x29	191
EA-33 T10×75	T10	75	10	128x60x29	191
EA-33 T15×75	T15	75	10	128x60x29	191
EA-33 T20×75	T20	75	10	128x60x29	191
EA-33 T25×75	T25	75	10	128x60x29	191
EA-33 T27×75	T27	75	10	128x60x29	191
EA-33 T30×75	T30	75	10	128x60x29	201
EA-33 T40×75	T40	75	10	128x60x29	201

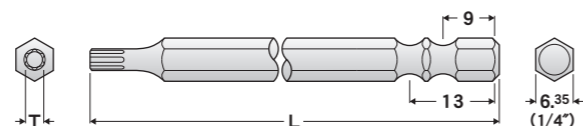

EA33  
T8~40×75

# BOREHOLE "TX" WRENCH

STANDARD LENGTH

## TXH-S8 DOOR HOLDER SET

■ SNCM+V<sup>®</sup> ■ Nickel plated

TX nominal size (Slide blister pack)

Item No.	Pcs.	T	Inner	W x H x D	g
TXH-S8	8	T8 T10 T15 T20 T25 T27 T30 T40	10	238x183x85	1,425

- 8 pcs. set consists of the most usable sizes from T8 to T40.
- Wrenches can be aligned in the case by simply closing the front cover (door).

Normal TX



※Tamper-resistant screws are usually made under special specifications, so our products might not be suitable for all tamper-resistant screws.

Specific production for special tamper-resistant screws is available.



TXH-S8

Borehole side

## TXH-\* INDIVIDUAL

TX nominal size (Slide blister pack)

Item No.	T	L1	L2	B	Hφ	DP	Inner	W x H x D	g
TXH-6	T 6	12	52	φ 2.3	0.7	1.5	30	180x122x45	220
TXH-8	T 8	12	58	2	0.7	1.5	30	180x122x45	220
TXH-10	T 10	15	60	2.5	1.0	1.7	30	180x122x45	261
TXH-15	T 15	20	65	3	1.3	2.0	30	180x122x45	313
TXH-20	T 20	22	68	3.5	1.8	2.2	30	180x122x45	380
TXH-25	T 25	25	72	4	2.1	2.5	30	180x122x45	466
TXH-27	T 27	27	76	4.5	2.4	3.0	20	215x160x70	515
TXH-30	T 30	28	80	5	2.7	3.2	20	215x160x70	600
TXH-40	T 40	32	90	6	3.2	3.7	20	215x160x70	820



TXH-40

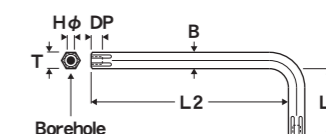

EXCELLENT SERIES

STANDARD SERIES

TX SERIES

L type

KNIFE type

SCREW DRIVER type

T type

SOCKET BIT type

BIT type

# “TX” WRENCH

STANDARD LENGTH

## TXL-S8 DOOR HOLDER SET

■ SNCM+V® special ■ Hard chrome plated



TXL-S8

TX nominal size (Slide blister pack)

Item No.	Pcs.	T								Inner	W x H x D	g
TXL-S8	8	T8	T10	T15	T20	T25	T27	T30	T40	10	240x185x87	1,525

- 8 pcs. set consists of the most usable sizes from T8 to T40.
- Wrenches can be aligned in the case by simply closing the front cover (door).

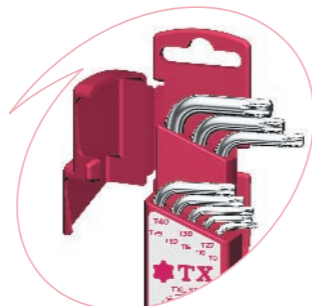

TXL-10

TX nominal size (Vinyl pouch)

Item No.	Pcs.	T						Inner	W x H x D	g
TXL-10	10	T10	T15	T20	T25	T27	T50	5	154x113x100	2,085

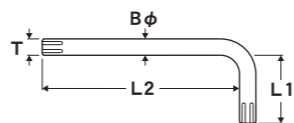

## TX-\* INDIVIDUAL

TX nominal size (Slide blister pack)

Item No.	T	L1	L2	Bφ	Inner	W x H x D	g
TX-8P	T 8	12	58	2.3	10	125x67x47	95
TX-10P	T 10	15	60	2.7	10	125x67x47	105
TX-15P	T 15	20	65	3.3	10	125x67x47	145
TX-20P	T 20	22	68	3.8	10	125x67x47	145
TX-25P	T 25	25	72	4.4	10	125x67x47	182
TX-27P	T 27	27	76	5	10	160x110x70	295
TX-30P	T 30	28	80	5.5	10	160x110x70	315
TX-40P	T 40	32	90	6.6	10	160x110x70	465
TX-45*	T 45	34	95	7.7	10	126x66x30	495
TX-50*	T 50	36	100	8.8	10	163x70x33	671
TX-55*	T 55	40	112	11.2	10	163x70x33	1,181

※Bulk pack for TX45-TX55



TX-40P

## IT \* INDIVIDUAL

■ SNCM+V® special ■ Black parkerized finish

TX nominal size (Bulk pack)

Item No.	T	L1	L2	B	Inner	W x H x D	g
<b>NEW</b> IT 8	T 8	15.5	47.6	2	30	100x80x50	102
<b>NEW</b> IT 10	T 10	17	51	2.5	30	100x80x50	132
<b>NEW</b> IT 15	T 15	18	54	3	30	100x80x50	162
<b>NEW</b> IT 20	T 20	19.5	57.5	3.5	30	100x80x50	222
<b>NEW</b> IT 25	T 25	20	60	4	30	100x80x50	312
<b>NEW</b> IT 27	T 27	21.5	63.5	4.5	20	100x80x50	282
<b>NEW</b> IT 30	T 30	23.5	70	5	20	100x80x50	342
<b>NEW</b> IT 40	T 40	26	76	6	20	100x80x50	642
<b>NEW</b> IT 45	T 45	28.5	82.5	7	20	100x80x50	782
<b>NEW</b> IT 50	T 50	32	95.5	8	20	100x80x50	1,142

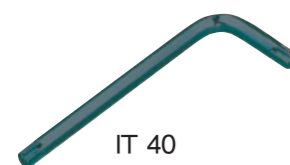

IT 40

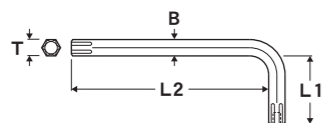

# KNIFE TYPE “TX” WRENCH

## TXN-\* STEEL CONTAINER SET

■ SNCM+V® ■ Black parkerized finish blades



TXN-8

TX nominal size (Slide blister pack)

Item No.	Pcs.	T								Inner	W x H x D	g
TXN-6	6	T10	T15	T20	T25	T30	T40			10	233x185x75	2,335
TXN-8	8	T9	T10	T15	T20	T25	T27	T30	T40	10	233x185x75	2,603

- All TX wrenches fold into steel container for easy carrying.
- The steel container works as a handle for tight fastening.
- Easy wrench can be inclined at any angle.
- Black parkerized finish for TX blades and nickel chrome plated steel container.

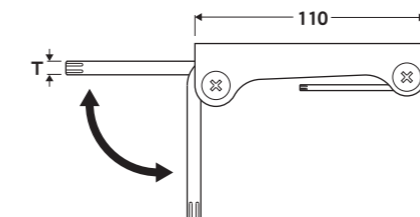

## TXN-\*N PLASTIC COVER METAL CONTAINER SET

■ SNCM+V® ■ Black parkerized finish blades



TXN-8N

TX nominal size (Slide blister pack)

Item No.	Pcs.	T								Inner	W x H x D	g
TXN-6N	6	T10	T15	T20	T25	T30	T40			10	202x173x80	1,807
TXN-8N	8	T8	T10	T15	T20	T25	T27	T30	T40	10	202x173x80	1,962

- Plastic-covered metal container is easy on the hands for comfortable operation.
- Hard steel plates applied to container frame ensure high durability against torque and tight fastening.

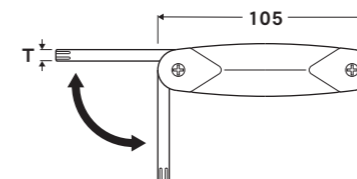



# BOREHOLE "TX" SCREWDRIVER with plastic handle

ORANGE COLOR

## TXDH-S6 VINYL POUCH SET

■ SNCM+V® special ■ Hard chrome plated blade

TX nominal size (Vinyl pouch)

Item No.	Pcs.	T						Inner	W x H x D	g
TXDH-S6	6	T6	T8	T10	T15	T20	T25	5	238x120x75	1,230

- High quality acetate plastic handle is resistant to both oil and chemicals, is extremely durable, and prevents slippage and damage from impact while being easy on the hands.
- Engineered for a high degree of tamper-resistance to offer positive engagement and high torque transmission.



TXDH-S6

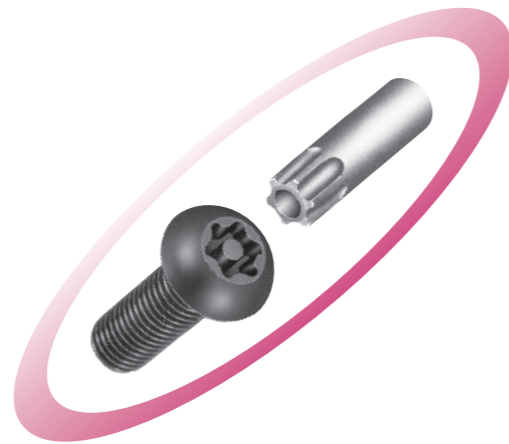

※Tamper-resistant screws are usually made under special specifications, so our products might not be suitable for all tamper-resistant screws.

Specific production for special tamper-resistant screws is available.

## TXDH-\* INDIVIDUAL

TX nominal size (Plastic hanger)

Item No.	T	L1	L2	Bφ	φ	Hφ	DP	Inner	W x H x D	g
TXDH-6	T 6	60	69	2.5	18	0.7	1.5	20	172x100x55	396
TXDH-7	T 7	65	69	2.5	18	0.7	1.5	20	172x100x55	397
TXDH-8	T 8	70	69	2.5	18	0.7	1.5	20	172x100x55	410
TXDH-9	T 9	70	84	3.3	22	0.8	1.5	20	195x114x60	588
TXDH-10	T 10	75	84	3.3	22	1.0	1.7	20	195x114x60	599
TXDH-15	T 15	80	84	3.3	22	1.3	2.0	20	195x114x60	602
TXDH-20	T 20	90	99	4.4	26	1.8	2.2	10	203x136x34	550
TXDH-25	T 25	100	99	4.4	26	2.1	2.5	10	203x136x34	559
TXDH-30	T 30	120	122	6.6	32	2.7	3.2	10	270x162x42	1,061
TXDH-40	T 40	130	122	6.6	32	3.2	3.7	10	270x162x42	1,096



TXDH-30

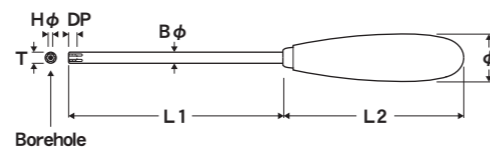

# BOREHOLE "TX" SCREWDRIVER with plastic handle

YELLOW COLOR

## NTDH-S4 VINYL POUCH SET

■ SNCM+V® ■ Black parkerized finish blade

TX nominal size (Vinyl pouch)

Item No.	Pcs.	T				Inner	W x H x D	g
NTDH-S4	4	T6	T8	T10	T15	5	205x114x63	524

- Plastic handle for easy gripping, with black parkerized finish blades.



NTDH-S4

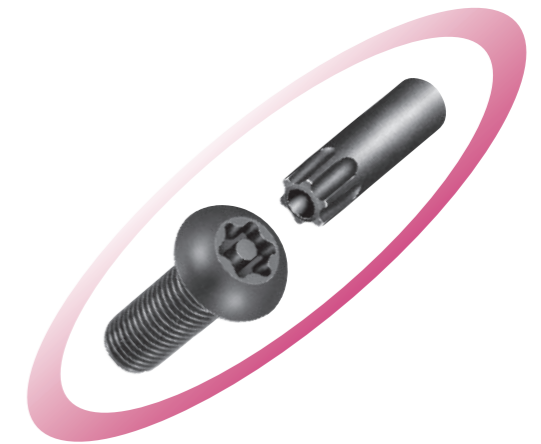

※Tamper-resistant screws are usually made under special specifications, so our products might not be suitable for all tamper-resistant screws.

## NTDH-\* INDIVIDUAL

TX nominal size (Bulk pack)

Item No.	T	L1	L2	Bφ	φ	Hφ	DP	Inner	W x H x D	g
NTDH-6	T 6	60	69	2.5	18	0.7	1.5	20	172x100x55	312
NTDH-8	T 8	70	69	2.5	18	0.7	1.5	20	172x100x55	312
NTDH-10	T 10	75	84	3.3	22	1.0	1.7	20	195x114x60	548
NTDH-15	T 15	80	84	3.3	22	1.3	2.0	20	195x114x60	548
NTDH-20	T 20	90	99	4.4	26	1.8	2.2	10	203x136x34	490
NTDH-25	T 25	100	99	4.4	26	2.1	2.5	10	203x136x34	490



NTDH-25

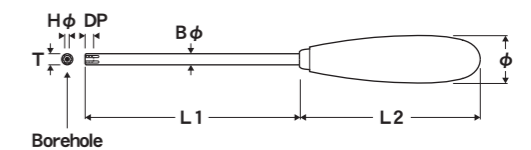

# “TX” SCREWDRIVER with plastic handle

GREEN COLOR

## TXD-S6 VINYL POUCH SET

■ SNCM+V® special ■ Hard chrome plated blade

TX nominal size (Vinyl pouch)

Item No.	Pcs.	T					Inner	W x H x D	g	
TXD-S6	6	T6	T8	T10	T15	T20	T25	6	244x160x80	1,340



TXD-S6

- High quality acetate plastic handle is resistant to both oil and chemicals, is extremely durable, and prevents slippage and damage from impact while being easy on the hands.

## TXD-\* INDIVIDUAL

■ SNCM+V® special ■ Hard chrome plated blade

TX nominal size (Bulk pack)

Item No.	T	L1	L2	B φ	φ	Inner	W x H x D	g
TXD-5	T 5	60	70	2.5	13	20	148x65x28	306
TXD-6	T 6	60	70	2.5	13	20	148x65x28	309
TXD-7	T 7	65	70	2.5	13	20	148x65x28	316
TXD-8	T 8	70	70	2.5	13	20	148x65x28	320
TXD-9	T 9	70	78	3.3	17	20	160x80x40	504
TXD-10	T 10	75	78	3.3	17	20	160x80x40	513
TXD-15	T 15	80	78	3.3	17	20	160x80x40	518
TXD-20	T 20	90	94	4.4	21	10	200x100x30	512
TXD-25	T 25	100	94	4.4	21	10	200x100x30	524
TXD-27	T 27	110	94	5.0	21	10	200x100x30	594
TXD-30	T 30	120	110	6.6	24	10	242x112x31	1,004
TXD-40	T 40	130	110	6.6	24	10	242x112x31	1,023



TXD-25

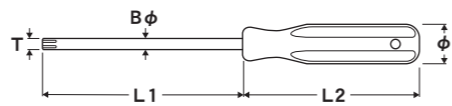

## XFD-\* INDIVIDUAL

■ SNCM+V® ■ Black parkerized finish blade

FLAG TYPE

TX nominal size (Poly bag with header)

Item No.	T	L1	L2	Overall length	Inner	W x H x D	g
XFD-6	T6	18	10	110	10	200x70x58	135
XFD-8	T8	20	12	112	10	200x70x58	138
XFD-10	T10	22	14	114	10	200x70x58	148
XFD-15	T15	26	16	116	10	200x70x58	167
XFD-20	T20	30	18	118	10	200x70x58	188



Newly developed attractive design and function !

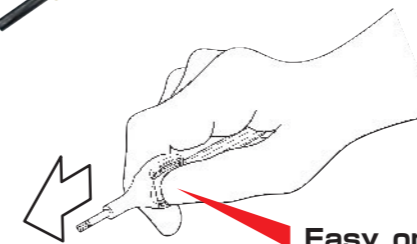
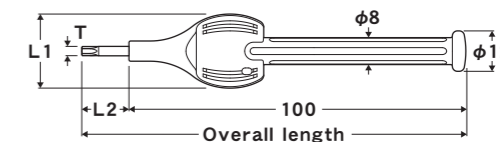

Easy one-hand operation for firm screw driving without coming, insured by the finger stopper and the handle fitting to the palm.

## MEMO

---

---

---

---

---

---

---

---

---

---

---

---

---

---

---

---

---

---

# T TYPE "TX" GRIP HANDLE WRENCH

PLASTIC HANDLE

XT-\* INDIVIDUAL

■ SNCM+V® special ■ Hard chrome plated blade

## MAXIMUM HIGH GRIPPING !



XT-50

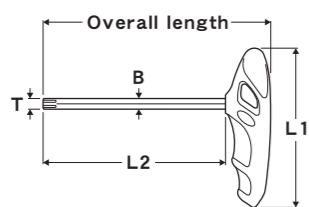

- Handle designed for optimum grip by reducing weight with a hole in the base and notched to prevent slippage.
- Cellulose acetate material provides extreme strength and high chemical resistance for the ultimate T-type wrench.
- Hard corrosion-resistant chrome plating.
- Grip type plastic handle equipped with thumb rest.

TX nominal size (Hanging header)

Item No.	T	L1	L2	B	Overall length	Inner	W x H x D	g
XT-15	T 15	75	86	3	108	10	162x113x65	278
XT-20	T 20	92	92	4	119	10	162x113x65	458
XT-25	T 25	92	92	4	119	10	162x113x65	487
XT-27	T 27	92	105	5	132	10	162x113x65	548
XT-30	T 30	92	105	5	132	10	162x113x65	548
XT-40	T 40	119	111	6	145	10	195x164x89	1,024
XT-45	T 45	119	137	8	171	10	195x164x89	1,413
XT-50	T 50	119	137	8	171	10	195x164x89	1,429



# NEW FLAG TYPE "TX" WRENCH

# FLAG TYPE "TX" WRENCH

PLASTIC HANDLE

XF-\* INDIVIDUAL

■ SNCM+V® ■ Black parkerized finish blade

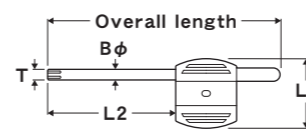
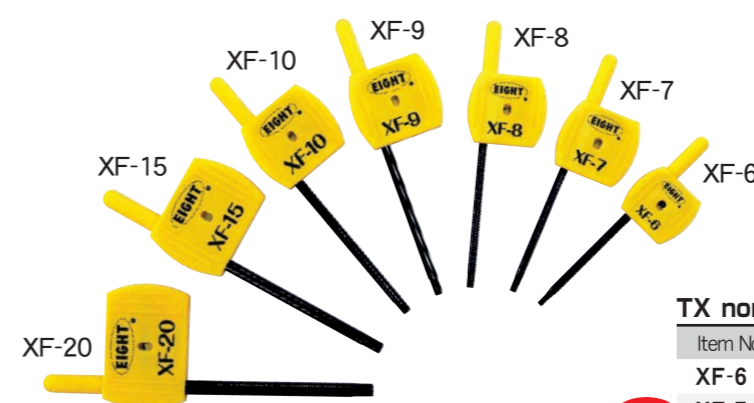

### SPECIAL FEATURES :

- Suitable flag sizes designed to gain the respective maximum torque.
- Fits the operator's hand perfecting to prevent slippage.

TX nominal size (Poly bag with header)

Item No.	T	L1	L2	Bφ	Overall length	Inner	W x H x D	g
XF-6	T 6	18	33	2.3	62	10	127x70x45	69
NEW XF-7	T 7	21	35	2.3	68	10	127x70x45	78
NEW XF-8	T 8	21	38	2.3	71	10	127x70x45	79
XF-9	T 9	24	41.5	2.8	77.5	10	127x70x45	94
XF-10	T 10	24	44.5	2.8	80.5	10	127x70x45	95
XF-15	T 15	29	46	3.3	84	10	200x72x57	132
XF-20	T 20	33	49	3.9	87	10	200x72x57	178

# WING TYPE "TX" WRENCH

PLASTIC HANDLE

XW-\* INDIVIDUAL

■ SNCM+V® special ■ Hard chrome plated blade

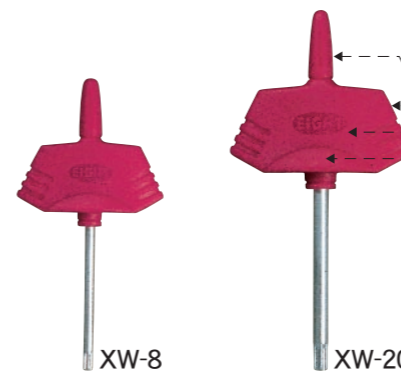

### SPECIAL FEATURES :

- High usability and high grade design.
- Tip enabling fast rotation of wrench.
- Rounded shape wing with beveled shoulders permits easy operation of turning and pressing down.
- Suitable size of wing designed for required torque.

TX nominal size (Bulk pack)

Item No.	T	L1	L2	Bφ	Overall length	Inner	W x H x D	g
XW-6	T 6	35	35	2.5	70	10	125x67x30	75
XW-7	T 7	35	35	2.5	70	10	125x67x30	75
XW-8	T 8	35	35	2.5	70	10	125x67x30	75
XW-9	T 9	35	35	2.7	70	10	125x67x30	75
XW-10	T10	45	45	3.3	89	10	161x67x35	140
XW-15	T15	45	45	3.3	89	10	161x67x35	140
XW-20	T20	45	45	3.8	89	10	161x67x35	160

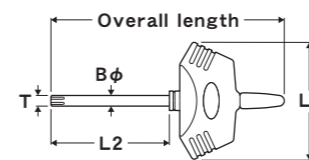

# "TX" BIT WITH BIT HOLDER

12.7 mm (1/2") square drive

## 21XBL / 21XB PLASTIC CASE SET

■ SNCM+V® special ■ Hard chrome plated bits

100mm and 45 mm overall length bits



21XBL-S6  
Plastic case dimensions : 140×70×28mm

### 100 mm length bits, TX nominal size (Plastic case)

Item No.	Drive	Pcs.	T	Inner	W x H x D	g
21XBL-S6	□12.7	6	T25 T27 T30 T40 T45 T50	10	350x163x75	3,642

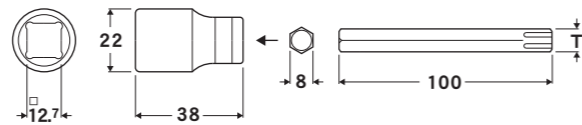

### 45 mm length bits, TX nominal size (Plastic case)

Item No.	Drive	Pcs.	T	Inner	W x H x D	g
21XB-S6	□12.7	6	T25 T30 T40 T45 T50 T55	10	350x163x75	2,372

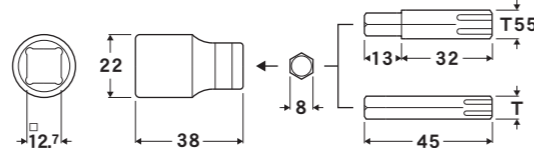

21XB-S6  
Plastic case dimensions : 136×67×25mm

## 21XBL / 21XB INDIVIDUAL

### 100 mm length bits (Poly bag with header)

Item No.	Overall length	T	Inner	W x H x D	g
21XBL-B25	100	T 25	10	170x68x50	429
21XBL-B27	100	T 27	10	170x68x50	429
21XBL-B30	100	T 30	10	170x68x50	439
21XBL-B40	100	T 40	10	170x68x50	449
21XBL-B45	100	T 45	10	170x68x50	459
21XBL-B50	100	T 50	10	170x68x50	469

### 45 mm length bits (Poly bag with header)

Item No.	Overall length	T	Inner	W x H x D	g
21XB-B25	45	T 25	10	128x69x49	202
21XB-B30	45	T 30	10	128x69x49	202
21XB-B40	45	T 40	10	128x69x49	212
21XB-B45	45	T 45	10	128x69x49	222
21XB-B50	45	T 50	10	128x69x49	232
21XB-B55	45	T 55	10	128x69x49	292

### Usage example

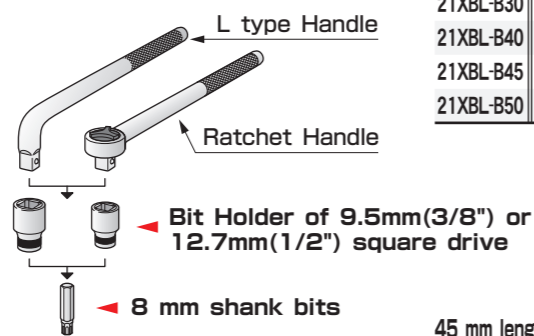

21XBL-B40

21XB-B40

Specific production of TX bits are available.



21-127P



83-8

### BIT HOLDER for 8 mm shank bits

■ SCM 435 ■ Chrome plated

#### INDIVIDUAL (Poly bag with header)

Item No.	Inner	W x H x D	g
21-127P	10	128x69x49	642

12.7mm (1/2") sq. drive

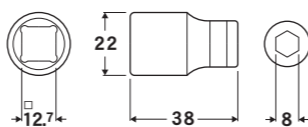

#### INDIVIDUAL (Poly bag with header)

Item No.	Inner	W x H x D	g
83-8	10	128x69x49	272

9.5mm (3/8") sq. drive

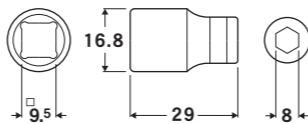

# "TX" SOCKET BIT

12.7 mm (1/2"), 9.5mm (3/8") square drive

## 21XSB-\* INDIVIDUAL

Standard length, 12.7mm (1/2") sq. drive



21XSB-20~55

9.5mm (3/8") sq. drive

## 83XSB-\* PLASTIC CASE SET

Standard length, 9.5mm (3/8") sq. drive



83XSB-2045  
Plastic case dimensions : 100×71×20mm

83XSB-45

12.7 DRIVE

### TX nominal size (Poly bag with header)

Item No.	Drive	T	D	D2	B	B2	L	Inner	W x H x D	g
NEW 21XSB-20	□12.7	T 20	23.3	33	34	8	67	10	128x69x49	752
NEW 21XSB-25	□12.7	T 25	23.3	33	34	8	67	10	128x69x49	772
NEW 21XSB-30	□12.7	T 30	23.3	33	34	8	67	10	128x69x49	772
NEW 21XSB-40	□12.7	T 40	23.3	33	34	8	67	10	128x69x49	792
NEW 21XSB-45	□12.7	T 45	23.3	33	34	8	67	10	128x69x49	792
NEW 21XSB-50	□12.7	T 50	23.3	33	34	8	67	10	128x69x49	792
NEW 21XSB-55	□12.7	T 55	23.3	38	34	10	72	10	128x69x49	942

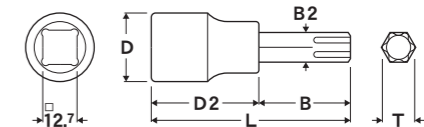

9.5 DRIVE

### TX nominal size (Plastic case)

Item No.	Drive	Pcs.	T	Inner	W x H x D	g
83XSB-2045	□9.5	6	T20 T25 T27 T30 T40 T45	10	280x112x80	2,502
83XSB-2550	□9.5	6	T25 T27 T30 T40 T45 T50	10	280x112x80	2,632

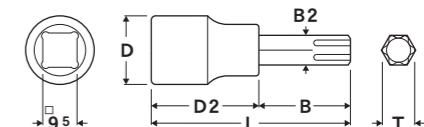

## 83XSB-\* INDIVIDUAL

Standard length

### TX nominal size (Poly bag with header)

Item No.	Drive	T	D	D2	B	B2	L	Inner	W x H x D	g
83XSB-20	□9.5	T 20	17	27	28	6.35	55	10	128x69x79	362
83XSB-25	□9.5	T 25	17	27	28	6.35	55	10	128x69x79	372
83XSB-27	□9.5	T 27	17	27	28	6.35	55	10	128x69x79	372
83XSB-30	□9.5	T 30	17	27	40	6.35	65	10	128x69x79	402
83XSB-40	□9.5	T 40	17	27	40	6.35	65	10	128x69x79	412
83XSB-45	□9.5	T 45	17	29	38	8	67	10	128x69x79	492
83XSB-50	□9.5	T 50	17	29	38	8	67	10	128x69x79	502

# "TX" E-TYPE SOCKET

## "TX" E-TYPE SOCKET

12.7 mm (1/2") square drive

## 21XE-\* INDIVIDUAL

■ SCM 435 ■ Nickel plated

### Nominal size (Bulk pack)

Item No.	Drive	E (mm)	D	L	Inner	W x H x D	g
21XE-10	□12.7	E 10 ( 9.42)	13.2	37	20	142x95x55	1,252
21XE-12	□12.7	E 12 (11.17)	15	37	20	142x95x55	1,332
21XE-14	□12.7	E 14 (12.9)	16.4	37	20	142x95x55	1,332
21XE-16	□12.7	E 16 (14.76)	18.8	37	20	142x95x55	1,412
21XE-18	□12.7	E 18 (16.7)	20.5	39	20	142x95x55	1,512
21XE-20	□12.7	E 20 (18.49)	23	39	20	142x95x55	1,592

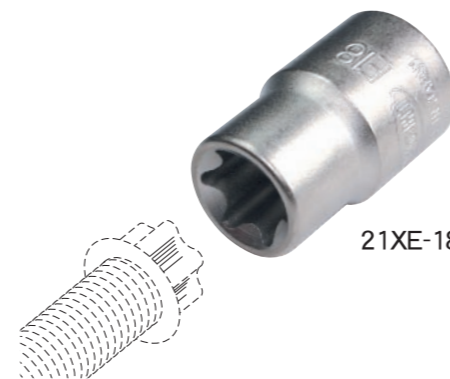

21XE-18

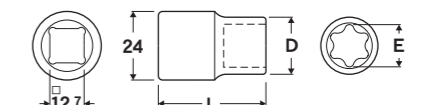

EXCELLENT SERIES

STANDARD SERIES

TX SERIES

L type

KNIFE type

12.7 DRIVE

T type

SOCKET BIT type

BIT type

12.7 DRIVE

12.7 DRIVE

EXCELLENT SERIES

STANDARD SERIES

TX SERIES

L type

KNIFE type

12.7 DRIVE

T type

SOCKET BIT type

BIT type

# BOREHOLE BALL POINT "TX" WRENCH

LONG LENGTH

## TXBH-S8 DOOR HOLDER SET

■ SNCM+V<sub>6</sub> special ■ Hard chrome plated

TX nominal size (Slide blister pack)

Item No.	Pcs.	T								Inner	W x H x D	g
TXBH-S8	8	T8	T10	T15	T20	T25	T27	T30	T40	5	217x94x88	975

- Ball Point type TX wrench with borehole on both ends, originally designed by EIGHT.
- Knurled finish ensures less slippage and easy operation.
- Available with inclining angle upto 25 degree for standard cap screws.

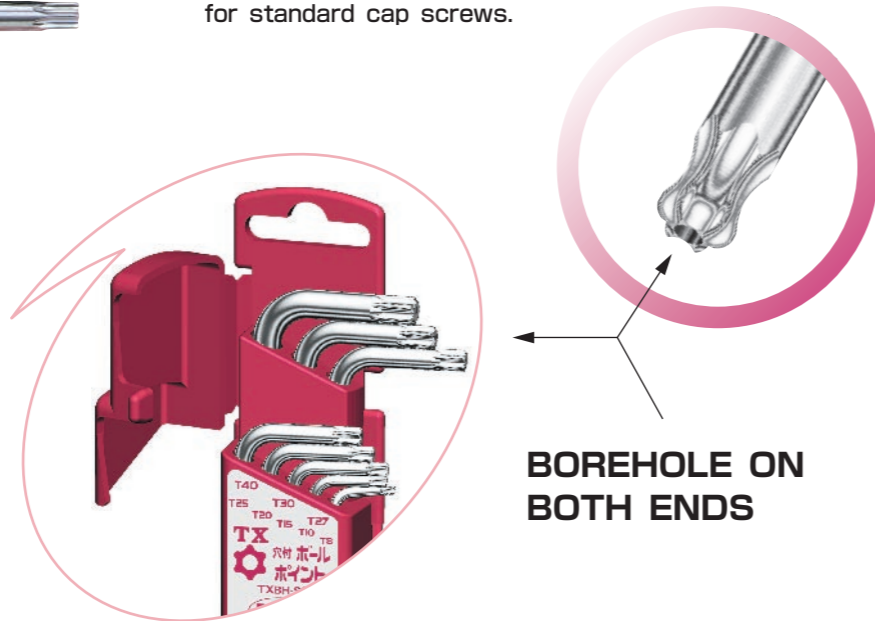
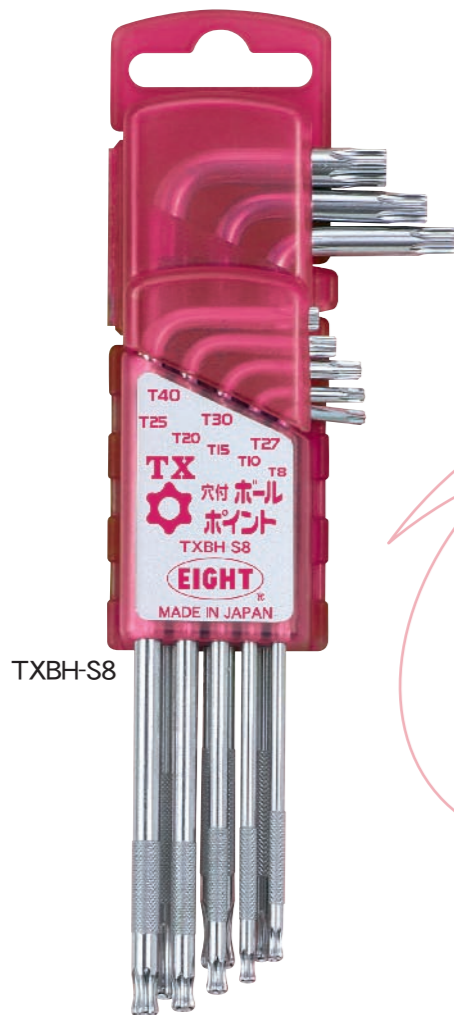

BOREHOLE ON BOTH ENDS

※ Tamper-resistant screws are usually made under special specifications, so our products might not be suitable for all tamper-resistant screws.

Specific production for special tamper-resistant screws is available.

### TXBH-\* INDIVIDUAL

TX nominal size (Slide blister pack)

Item No.	T	L1	L2	Bφ	Hφ	DP	Inner	W x H x D	g
TXBH-8	T 8	17	86	2.5	0.7	1.0	10	170x68x50	146
TXBH-10	T 10	18	94	2.7	1.0	1.2	10	170x68x50	162
TXBH-15	T 15	21	99	3.3	1.3	1.6	10	170x68x50	184
TXBH-20	T 20	22	106	3.8	1.8	2.0	10	170x68x50	222
TXBH-25	T 25	25	110	4.4	2.1	2.1	10	170x68x50	266
TXBH-27	T 27	27	115	5.0	2.4	2.3	10	214x88x63	384
TXBH-30	T 30	29	123	5.5	2.7	2.5	10	214x88x63	442
TXBH-40	T 40	32	133	6.6	3.2	3.1	10	214x88x63	604

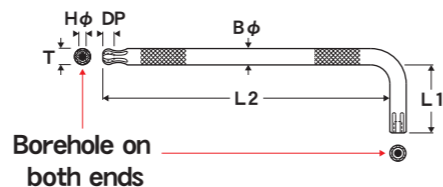

Borehole on both ends

# BALL POINT "TX" WRENCH

LONG LENGTH

## TXB-S\* DOOR HOLDER SET

■ SNCM+V<sub>6</sub> special ■ Hard chrome plated

TX nominal size (Slide blister pack)

Item No.	Pcs.	T								Inner	W x H x D	g
TXB-S8	8	T8	T10	T15	T20	T25	T27	T30	T40	5	217x94x88	979
TXB-S8Z	8	T9	T10	T15	T20	T25	T27	T30	T40	5	217x94x88	979

- Ball Point type TX wrench, originally designed by EIGHT.
- Knurled finish ensures less slippage and easy operation.
- Available with inclining angle upto 25 degree.

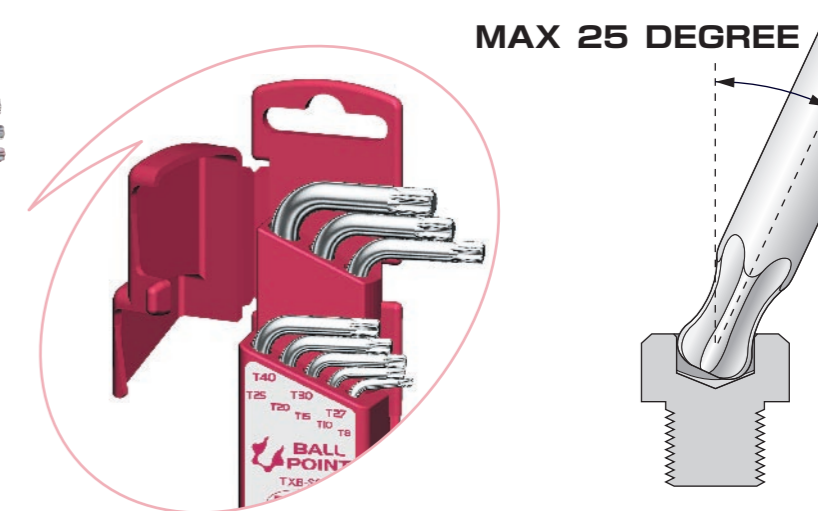
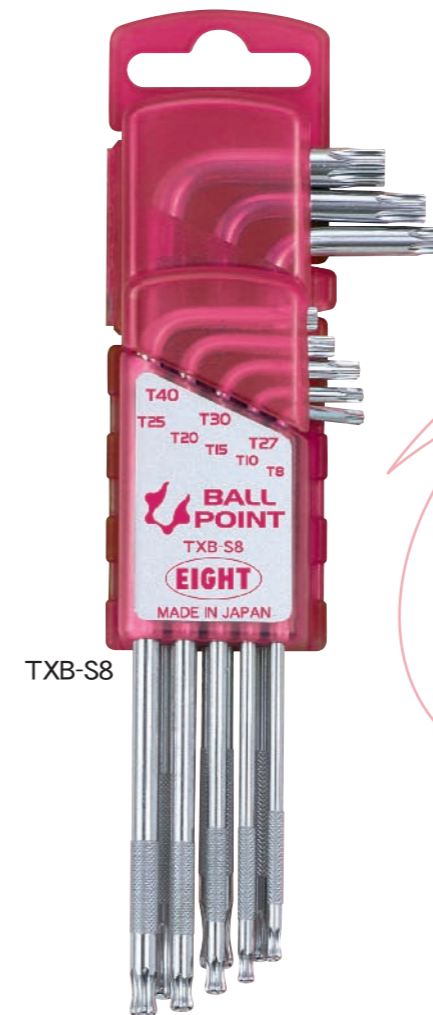

MAX 25 DEGREE

- Easy-to-open front cover (door) for easy storage and removal.
- Smooth taking in and out enabled by the front cover (Door) which holds the wrenches.
- Wrenches can be aligned in the case by simply closing the front cover (door).
- Hanging-type holders for easy storage.

### TXB-\* INDIVIDUAL

TX nominal size (Slide blister pack)

Item No.	T	L1	L2	Bφ	Inner	W x H x D	g
TXB-8	T 8	17	86	2.5	10	170x68x50	146
TXB-9	T 9	17	87	2.5	10	170x68x50	148
TXB-10	T 10	18	94	2.7	10	170x68x50	162
TXB-15	T 15	21	99	3.3	10	170x68x50	184
TXB-20	T 20	22	106	3.8	10	170x68x50	222
TXB-25	T 25	25	110	4.4	10	170x68x50	266
TXB-27	T 27	27	115	5.0	10	214x88x63	384
TXB-30	T 30	29	123	5.5	10	214x88x63	442
TXB-40	T 40	32	133	6.6	10	214x88x63	604

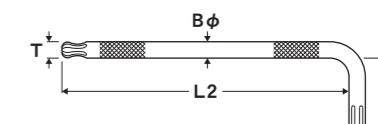
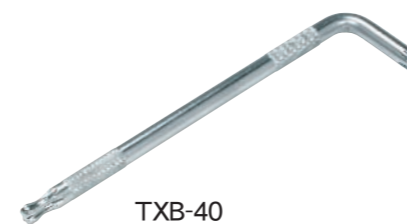

EXCELLENT SERIES

STANDARD SERIES

TX SERIES

L type

KNIFE type

SCREW DRIVER type

T type

SOCKET BIT type

BIT type

Lined area for writing notes.

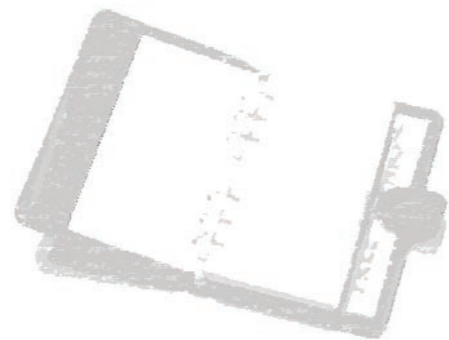

**DATA**

CUSTOM-MADE PRODUCTS 92~93

CONFORMITY CHART OF SCREW  
CONVERSION CHART 94~95

ABOUT TORQUE 96~97

ALPHABETICAL INDEX  
ITEM No. & CODE # 98~101



With decades of experience in special production to meet our customers' requirements, we welcome custom-made product requests and serve only the highest quality products under our proud reputation as a "Specialized Hexagon Wrenches manufacture".

Please feel free to contact us for any custom-made production tools even other than Hexagon Wrenches.

**EXAMPLE : Extra Big size Wrench**



**Extra -large size L-type Hexagon wrench**  
 Nominal size = 36 mm. L1=400 mm. L2=600 mm.  
 ● Available 0.71 ~ 50 mm. both in Metric and Inch sizes.  
 ● Any bending angles and lengths applicable.

**EXAMPLE : Special End Type Wrench**

**Both Ends Ball Point Type Wrench with Special Short Arm**  
 9 pcs. Set of Nominal size 1.5 ~ 10 mm.

- Short-arm end of Taper Head for strong tightening and Long-arm end of Neo-Ball for wide inserting angles up to 35 degrees.
- Special short arm suitable for work in narrow and cramped places and 35 degree angle ensures fast fastening work.



**Projection Tipped Hexagon Wrench**  
 6 pcs. Set of Nominal size 3 ~ 10 mm.  
 ● Both ends provided with a projection to fit pilot recess bolts.  
 ● Any sizes available.



\* Pilot recess bolt is a bolt with a hexagonal socket head with a guide hole at the center for safe fastening work without the tool slipping away from the hole.

**EXAMPLE : Crank Type Wrench**

**Crank-Shaped Hex and Hexalobular Ended Wrench**  
 Nominal size 5 mm. Hexalobular T30

- Suitable for speed fastening by crank shape.
- Any bending angles and lengths applicable.



**EXAMPLE : Bent type**

**L-Type Hex Wrench with Handle**  
 Nominal size 8 mm.

- Enables strong tightening.
- Safe and comfortable work with secure-grip handle.



**Offset shape Bent Type Hex Driver**  
 Nominal size 6 mm.  
 ● Suitable for easy work when the bolt is obstructed and standard L-types do not work.  
 ● Any bending shapes available.

**EXAMPLE : Thick-neck Socket Bit**

**Thick-neck Taper Head Socket Bit**  
 Nominal size 10 mm. Overall Length 110 mm.

- Neck 10% thicker than standard taper head to ensure better tightening.
- Economical black finish also available.
- Any lengths available.



**EXAMPLE : Extremely long type**

**Steel Handle T-Type Hexagon Wrench**  
 Nominal size 6 mm. Blade length 1,000 mm.

- Nominal sizes 2 ~ 17 mm. available.
- Actual production experience up to 1,000 mm. blade length.

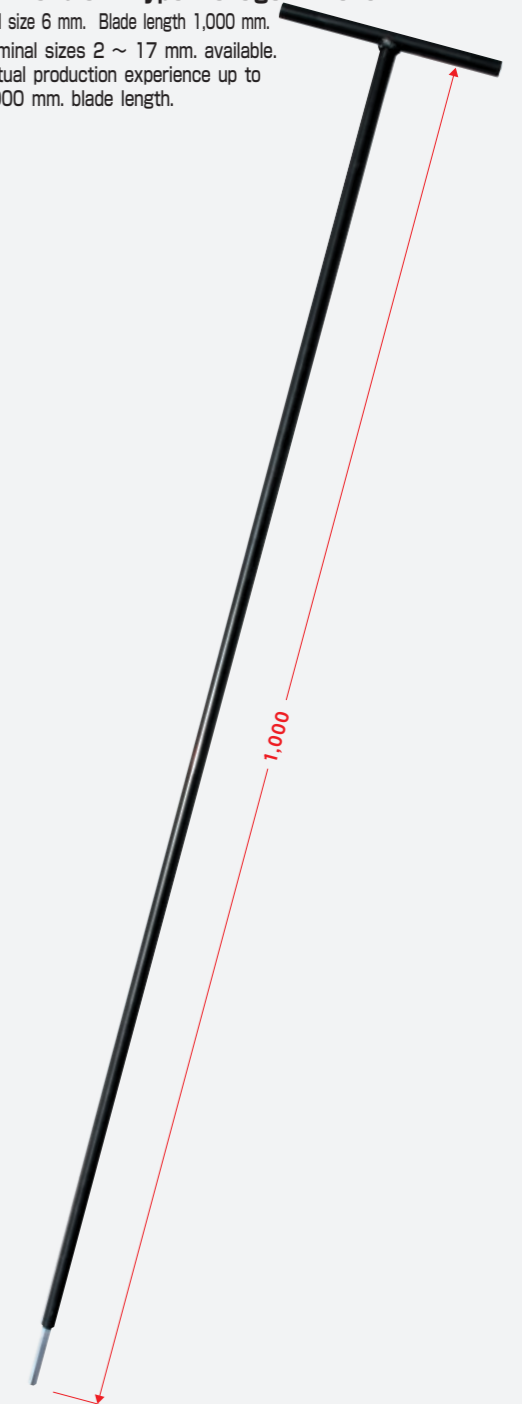

**EXAMPLE : Triple square**



**Triple Square Socket Bit**

- Triple Square M12 Overall Length 60 mm.
- Triple Square M14 Overall Length 140 mm.
- Socket bit for a specific socket head bolt that has an outer shape of 12 angles, called the Triple Square as used in European vehicles.
- Any sectional shapes available.
- Any length applicable.

**EXAMPLE : Various bits**

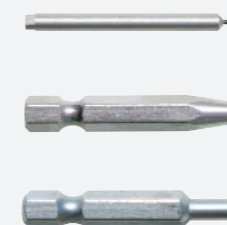

**Special Bit (for Torque Wrench)** in Micro Nominal size 0.89 mm. x 40 mm. overall length.  
 ● Any lengths and sizes applicable.

**Hex Bit in Micro size** Nominal size 0.89 mm. x 50 mm. overall length.  
 ● Inserted micro size hexagonal bit into hex shank.  
 ● Available Hex Bits from Nominal sizes 0.71 ~ 12 mm. for 45 ~ 300 mm. overall length.  
 ● Any specifications for overall length, groove size, bit shape and sizes applicable.

**Taper Head Hex Bit** Nominal size 3 mm. x 200 mm. overall length.  
 ● Any specifications for overall length, groove size, bit shape and sizes applicable.

# Hexagon wrench and Cap/Set Screw, Bolt NOMINAL SIZE CHART

# "TX" wrench and Cap/Set Screw, Bolt NOMINAL SIZE CHART AND CONVERSION CHART

DATA

## Metric size

## Inch size

NOMINAL SIZE	CAP BOLT	SET SCREW	FLAT HEAD SCREW	BUTTON HEAD BOLT	TAPER PLUG SCREW
0.71		M 1.4 M 1.6 M1.8			
0.89		M 2			
1.27	M 1.4	M 2.5			
1.5	M 1.6 M 2	M 3			
2	M 2.5	M 4	M 3	M 3	
2.5	M 3	M 5	M 4	M 4	
3	M 4	M 6 W1/4"	M 5	M 5	
4	M 5	M 8 W5/16"	M 6	M 6	
5	M 6 W1/4"	M10 W3/8"	M 8	M 8	1/8"
6	M 8 W5/16"	M12 W1/2"	M10	M10	1/4"
8	M10 W3/8" W7/16"	M16 W5/8"	M12	M12	3/8"
10	M12 W1/2"	M18 W3/4"	M14 M16	M14 M16	1/2"
12	M14	M22 M24	M18 M20	M18 M20	
14	M16 W5/8" M18 W3/4"		M22 M24	M22 M24	3/4"
17	M20 W7/8" M22 W1"				1"
19	M24 M27 W1 1/8"				
21	W1 1/4" W1 3/8"				
22	M30				1 1/2"
24	M33				
26	W1 1/2" W1 3/4"				
27	M36 M39				
32	M42 M45 W2"				
36	M48 M52				

NOMINAL SIZE	CAP BOLT	SET SCREW	FLAT HEAD SCREW	BUTTON HEAD BOLT	TAPER PLUG SCREW
0.028"		# 0 (1.52)			
0.035"		# 1 (1.85) # 2 (2.18)	# 0 (1.52)	# 0 (1.52)	
0.05"	# 0 (1.52)	# 3 (2.51) # 4 (2.84)	# 1 (1.85) # 2 (2.18)	# 1 (1.85) # 2 (2.18)	
1/16"	# 1 (1.85) # 2 (2.18) # 3 (2.51)	# 5 (3.17) # 6 (3.50)	# 3 (2.51) # 4 (2.84)	# 3 (2.51) # 4 (2.84)	
5/64"	# 4 (2.84) # 5 (3.17)	# 8 (4.16)	# 5 (3.17) # 6 (3.50)	# 5 (3.17) # 6 (3.50)	
3/32"	# 6 (3.50)	#10 (4.82)	# 8 (4.16)	# 8 (4.16)	
7/64"					
1/8"		1/4"	#10 (4.82)	#10 (4.82)	
9/64"	# 8 (4.16)				
5/32"	#10 (4.82)	5/16"	1/4"	1/4"	1/16"
3/16"	1/4"	3/8"	5/16"	5/16"	1/8"
7/32"		7/16"	3/8"	3/8"	
1/4"	5/16"	1/2"	7/16"		1/4"
5/16"	3/8"	5/8"	1/2"	1/2"	3/8"
3/8"	7/16" 1/2"	3/4"	5/8"	5/8"	1/2"
7/16"	9/16"				
1/2"	5/8"	7/8"	3/4"		
9/16"		1" 1 1/8"			3/4"
5/8"	3/4"	1 1/4" 1 3/8"			1"
3/4"	7/8" 1"	1 1/2"			1 1/4"
7/8"	1 1/8" 1 1/4"				
1"	1 3/8" 1 1/2"	1 3/4" 2"			1 1/2" 2"

The figures in parentheses show metric size and the fractions show size in inches.

The inch size screws are Unify screw in ISO standards. Unify screw is specified as the screw with 60 degree thread both in UNF and UNC specification.

The prefix W stands for the screw of Whitworth size and M for metric size. The figures after these prefixes show the diameter of given screw or bolt.

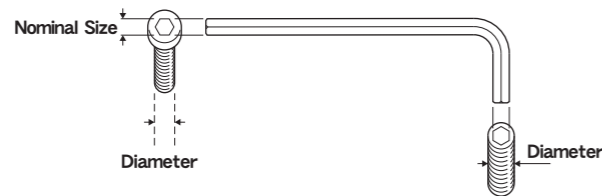

## CONVERSION TABLE OF INCH AND METRIC SIZE

1/8" = 3.18mm	1/4" = 6.35mm	5/16" = 7.94mm	3/8" = 9.53mm
7/16" = 11.11mm	1/2" = 12.70mm	9/16" = 14.29mm	5/8" = 15.88mm
3/4" = 19.05mm	7/8" = 22.23mm	1" = 25.4mm	

## "TX"

NOMINAL SIZE	"TX" DIAMETER	CAP BOLT	SET SCREW	FLAT HEAD SCREW	BUTTON HEAD BOLT
T 6	1.67		M 3		
T 7	2.00		# 6		# 4
T 8	2.30	M 2.5	M 4 # 8		
T 9	2.49			# 4	
T 10	2.72	M 3 # 4 # 5	M 5 #10	M 3 # 5	M 3 # 6
T 15	3.26	# 6		# 6	# 8
T 20	3.84		M 6 1/4"	M 4 # 8	M 4
T 25	4.40	M 4 # 8		M 5 #10	M 5 #10
T 27	4.96	M 5 #10	M 8 5/16"		1/4"
T 30	5.49	M 6 1/4"	3/8"	M 6 1/4"	M 6
T 40	6.60		M10	M 8 5/16"	M 8 5/16"
T 45	7.70	M 8 5/16"	M12 1/2"	3/8"	3/8"
T 50	8.79	M10 3/8"	M14	M10 7/16" 1/2"	M10
T 55	11.17	M12 7/16" 1/2"	M16	M12 5/8"	M12 1/2"
T 60	13.20	M14	M20	M16 3/4"	M16 5/8"

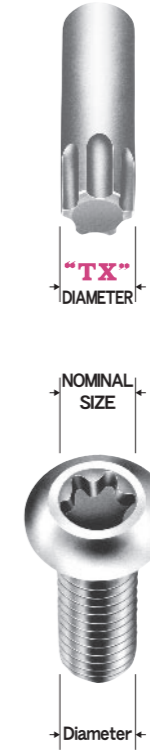

## CONVERSION TABLE OF DIAMETER

.....

# 4 = 2.84mm
# 5 = 3.17mm
# 6 = 3.50mm
# 8 = 4.16mm
#10 = 4.82mm
1/4" = 6.35mm
5/16" = 7.94mm
3/8" = 9.53mm
7/16" = 11.11mm
1/2" = 12.70mm
5/8" = 15.88mm

## "TX" E-TYPE

NOMINAL SIZE	Diameter of "E" shape bolt
E 10	M 8
E 12	M10
E 14	M12
E 16	
E 18	M14
E 20	M16



## CONVERSION TABLE OF NOMINAL SIZE AND METRIC SIZE

.....

E10 = 9.42mm
E12 = 11.17mm
E14 = 12.90mm
E16 = 14.76mm
E18 = 16.70mm
E20 = 18.49mm

## CONVERSION TABLE OF INCH AND METRIC SIZE

Inch size	Metric size
0.028"	0.711
0.035"	0.889
0.05"	1.270
1/16"	1.588
5/64"	1.984
3/32"	2.381
7/64"	2.778
1/8"	3.175
9/64"	3.571
5/32"	3.969
3/16"	4.763
7/32"	5.556
1/4"	6.350
9/32"	7.143
5/16"	7.938
3/8"	9.525
7/16"	11.113
1/2"	12.700
9/16"	14.288
5/8"	15.875
3/4"	19.050
7/8"	22.225
1"	25.400

DATA



## WHAT IS TORQUE?

- Torque is the tendency of a force to rotate an object about an axis, fulcrum, or pivot.
- Torque is used to express the force turning a bolt or screw by hexagon wrench.
- Torque is calculated by multiplying <power> by <distance>.

$$F \times L = T \quad F: \text{Power (N)}, L: \text{Distance (m)}, T: \text{Torque (N} \cdot \text{m)}$$

For example : when a Hexagon socket screw is tightened with a hexagon wrench by Power 10N of handpower applying the wrench at the 0.2 m. Distance point from the center of the bolt,

Torque is 2.0 N · m as obtained by the expression 10N x 0.2m=2.0 N · m

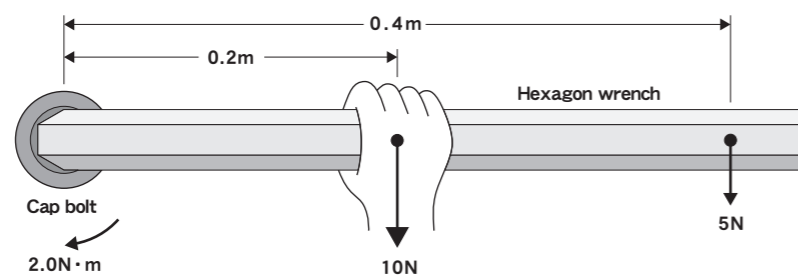

- ISO and JIS specify that hexagonal wrenches shall not be broken or cause any irregularities such as twisting, deformation in the hexagon shape, or bending when used within proof torque values (ISO 2934, JIS B 41648). JIS specification shows proof torque values for each size as well as the test method using a torque wrench.

COMPARISON TABLE ON GUARANTEED AND MAXIMUM TORQUE BETWEEN EIGHT EXCELLENT PRODUCTS AND JIS · ISO STANDARDS (Reference) Unit : N · m

Size in mm	Standards	Item	HEXAGON WRENCH		BALL POINT WRENCH		TAPER HEAD WRENCH		HARDNESS in HRC
			GRNTD.	MAX.	GRNTD.	MAX.	GRNTD.	MAX.	
1.5	EIGHT		0.88	1.28	0.49	0.64	0.49	0.64	57.5
	JIS · ISO		0.82						52.0
2	EIGHT		2.25	3.22	1.39	1.58	1.41	1.58	57.5
	JIS · ISO		1.90						52.0
2.5	EIGHT		4.21	6.02	2.75	3.24	2.83	3.58	57.5
	JIS · ISO		3.80						52.0
3	EIGHT		7.85	11.20	5.02	5.61	5.11	5.83	57.0
	JIS · ISO		6.60						52.0
4	EIGHT		19.00	25.00	12.00	13.00	13.00	15.00	56.5
	JIS · ISO		16.00						52.0
5	EIGHT		37.00	48.00	20.60	25.00	22.00	28.00	56.5
	JIS · ISO		30.00						52.0
6	EIGHT		70.00	87.00	36.00	40.00	38.00	46.00	56.5
	JIS · ISO		52.00						52.0
8	EIGHT		158.00	215.80	80.00	95.00	90.00	105.00	55.0
	JIS · ISO		120.00						50.0
10	EIGHT		268.00	411.00	158.50	171.50	182.00	208.00	55.0
	JIS · ISO		220.00						48.0
12	EIGHT		480.00	620.00			290.00	320.00	54.0
	JIS · ISO		370.00						48.0
14	EIGHT		740.00	990.00			440.00	515.00	54.0
	JIS · ISO		590.00						48.0
17	EIGHT		1,350.00				800.00	910.00	53.0
	JIS · ISO		980.00						45.0
19	EIGHT		1,850.00				1,100.00	1,240.00	53.0
	JIS · ISO		1,360.00						45.0

### REMARKS:

- GUARANTEED TORQUE (GRNTD): Maximum torque of tightening a screw without transformation and breakage.
- MAXIMUM TORQUE (MAX) : Maximum torque of tightening a screw at the time of breakage.

\* The figure of maximum torque is the most important to evaluate the durability of tools.

ALPHABETICAL INDEX

Easy access to the required product by Item No. & Code #.

Table with 8 columns: Item No. (Code #), Page, Item No. (Code #), Page, Item No. (Code #), Page, Item No. (Code #), Page. Lists various product codes and their corresponding page numbers.

ALPHABETICAL INDEX

Table with 8 columns: Item No. (Code #), Page, Item No. (Code #), Page, Item No. (Code #), Page, Item No. (Code #), Page. Lists various product codes and their corresponding page numbers.

DATA

DATA

# ALPHABETICAL INDEX

Easy access to the required product by Item No. & Code #.

Item No. (Code #)	Page	Item No. (Code #)	Page	Item No. (Code #)	Page	Item No. (Code #)	Page
No.001N-3.5	54	No.008-7/32"	55	No.016-4mm	59	ST-10	36
No.001N-3/16"	54	No.008-7/64"	55	No.016-5.5mm	59	ST-12	36
No.001N-3/32"	54	No.008-7/8"	55	No.016-5/16"	59	ST-14	36
No.001N-3/8"	54	No.008-7mm	55	No.016-5/32"	59	ST-2.5	36
No.001N-4	54	No.008-8mm	55	No.016-5/64"	59	ST-3	36
No.001N-4.5	54	No.008-9/16"	55	No.016-5mm	59	ST-4	36
No.001N-5	54	No.008-9/64"	55	No.016-6mm	59	ST-5	36
No.001N-5.5	54	No.008-9mm	55	No.016-7/32"	59	ST500-3	36
No.001N-5/16"	54	No.009-1	60	No.016-7/64"	59	ST500-4	36
No.001N-5/32"	54	No.009-2	60	No.016-8mm	59	ST500-5	36
No.001N-5/64"	54	No.009-3	60	No.016-9/64"	59	ST500-6	36
No.001N-6	54	No.009-4	60	No.018-1	65	ST500-8	36
No.001N-7	54	No.009-8	60	No.018-2	65	ST-6	36
No.001N-7/32"	54	No.012-3	53	NTDH-10	81	ST-8	36
No.001N-8	54	No.012-4	53	NTDH-15	81	STT-10	35
No.001N-9	54	No.013-1	53	NTDH-20	81	STT-12	35
No.002-11	53	No.014-1	56	NTDH-25	81	STT-14	35
No.002-12	53	No.014-1.5mm	57	NTDH-6	81	STT-3	35
No.002-2	53	No.014-1/16"	57	NTDH-8	81	STT-4	35
No.002-3	53	No.014-1/2"	57	NTDH-S4	81	STT-5	35
No.002-4	53	No.014-1/4"	57	PTH-2	66	STT500-3	35
No.002-5	53	No.014-1/8"	57	PTH-2.5	66	STT500-4	35
No.004-1	51	No.014-10mm	57	PTH-3	66	STT500-5	35
No.004-2	51	No.014-11mm	57	PTH-4	66	STT500-6	35
No.004-2NP	51	No.014-12mm	57	PTH-5	66	STT500-8	35
No.004-3	51	No.014-14mm	57	PTH-6	66	STT-6	35
No.004-4	51	No.014-17mm	57	PTH-8	66	STT-8	35
No.004-5	51	No.014-19mm	57	PTT-2.5	66	SYU-W34	61
No.004-5NP	51	No.014-2	56	PTT-3	66	SYU-W56	61
No.004-6	51	No.014-2.5mm	57	PTT-4	66	T-1.5	28
No.006-1.5mm	63	No.014-2mm	57	PTT-5	66	T-10	28
No.006-2.5mm	63	No.014-3	56	PTT-6	66	T-12	28
No.006-2mm	63	No.014-3/16"	57	PTT-8	66	T-14	28
No.006-3	63	No.014-3/32"	57	R-0.05"	29	T-17	28
No.006-3mm	63	No.014-3/4"	57	R-1.5	29	T-19	28
No.006-4mm	63	No.014-3/8"	57	R-1/16	29	T-2	28
No.006-5mm	63	No.014-3mm	57	R-1/2	29	T-2.5	28
No.006-6mm	63	No.014-4	56	R-1/4	29	T-3	28
No.008-1	55	No.014-4mm	57	R-1/8	29	T-4	28
No.008-1.5mm	55	No.014-5.5mm	57	R-10	29	T-5	28
No.008-1/16"	55	No.014-5/16"	57	R-12	29	T-6	28
No.008-1/2"	55	No.014-5/32"	57	R-14	29	T-8	28
No.008-1/4"	55	No.014-5/64"	57	R-17	29	TA14-1.5	67
No.008-1/8"	55	No.014-5/8"	57	R-19	29	TA14-10	67
No.008-1"	55	No.014-5mm	57	R-2	29	TA14-1510D	67
No.008-10mm	55	No.014-6mm	57	R-2.5	29	TA14-2	67
No.008-12mm	55	No.014-7/16"	57	R-3	29	TA14-2.5	67
No.008-14mm	55	No.014-7/32"	57	R-3/16	29	TA14-3	67
No.008-17mm	55	No.014-7mm	57	R-3/32	29	TA14-4	67
No.008-19mm	55	No.014-8mm	57	R-3/4	29	TA14-5	67
No.008-2	55	No.014-9	56	R-3/8	29	TA14-6	67
No.008-2.5mm	55	No.014-9/16"	57	R-4	29	TA14-8	67
No.008-21mm	55	No.014-9/32"	57	R-5	29	TD-1.3	32
No.008-22mm	55	No.014-9mm	57	R-5/16	29	TD-1.5	32
No.008-24mm	55	No.016-0.05"	59	R-5/32	29	TD-1.6	32
No.008-26mm	55	No.016-1.27mm	59	R-5/64	29	TD-1/4	32
No.008-27mm	55	No.016-1.5mm	59	R-6	29	TD-1/8	32
No.008-2mm	55	No.016-1/16"	59	R-7/32	29	TD-2	32
No.008-3/16"	55	No.016-1/4"	59	R-7/64	29	TD-2.5	32
No.008-3/32"	55	No.016-1/8"	59	R-8	29	TD-3	32
No.008-3/4"	55	No.016-10mm	59	R-9/64	29	TD-3/16	32
No.008-3/8"	55	No.016-12mm	59	RR-S6	62	TD-3/32	32
No.008-3mm	55	No.016-14mm	59	RS-13ZD	29	TD-4	32
No.008-4mm	55	No.016-17mm	59	RS-6	29	TD-5	32
No.008-5.5mm	55	No.016-19mm	59	RS-7	29	TD-5/32	32
No.008-5/16"	55	No.016-2.5mm	59	RS-7D	29	TD-6	32
No.008-5/32"	55	No.016-22mm	59	RS-8	29	TD-7/32	32
No.008-5/64"	55	No.016-2mm	59	RS-8ZD	29	TD-7/64	32
No.008-5/8"	55	No.016-3/16"	59	RS-9	29	TD-9/64	32
No.008-5mm	55	No.016-3/32"	59	RS-9D	29	TEL-1/16	14
No.008-6mm	55	No.016-3/8"	59	SQH-635	43	TEL-1/4	14
No.008-7/16"	55	No.016-3mm	59	SQN-635TX	43	TEL-1/8	14

# ALPHABETICAL INDEX

Item No. (Code #)	Page	Item No. (Code #)	Page	Item No. (Code #)	Page	Item No. (Code #)	Page
TEL-3/16	14	TLS-9NP	13	TXB-40	89	TXL-S8	78
TEL-3/32	14	TLS-9NX	15	TXB-8	89	TXN-6	79
TEL-3/8	14	TLS-9ZD	27	TXB-9	89	TXN-6N	79
TEL-5/16	14	TM-1.5	26	TXBH-10	88	TXN-8	79
TEL-5/32	14	TM-10	26	TXBH-15	88	TXN-8N	79
TEL-5/64	14	TM-2	26	TXBH-20	88	VS-10P	31
TEL-S9ZD	17	TM-2.5	26	TXBH-25	88	VS-2.5P	31
TL-0.05"	26	TM-3	26	TXBH-27	88	VS-3P	31
TL-1.5	14	TM-4	26	TXBH-30	88	VS-4P	31
TL-1/16	26	TM-5	26	TXBH-40	88	VS-5P	31
TL-1/2	14	TM-6	26	TXBH-8	88	VS-6P	31
TL-1/4	26	TM-8	26	TXBH-S8	88	VS-7C	31
TL-1/8	26	TMS-7	26	TXB-S8	89	VS-8P	31
TL-10	14	TMS-7D	27	TXB-S8Z	89	VS-S6	31
TL-11	14	TMS-9	26	TXD-10	82	WHH-10TL	15
TL-12	14	TMS-9D	27	TXD-15	82	WHH-3TL	15
TL-14	14	TS-6	28	TXD-20	82	WHH-4TL	15
TL-17	14	TS-7	28	TXD-25	82	WHH-5TL	15
TL-19	14	TS-7S	28	TXD-27	82	WHH-6TL	15
TL-2	14	TS-7SD	28	TXD-30	82	WHH-8TL	15
TL-2.5	14	TS-8	28	TXD-40	82	WP-S2	13
TL-3	14	TS-8D	28	TXD-5	82	XF-10	85
TL-3/16	26	TS-9	28	TXD-6	82	XF-15	85
TL-3/32	26	TS-9D	28	TXD-7	82	XF-20	85
TL-3/4	14	TT-1.5P	19	TXD-8	82	XF-6	85
TL-3/8	26	TT-10P	19	TXD-9	82	XF-7	85
TL-4	14	TT-2.5P	19	TXDH-10	80	XF-8	85
TL-5	14	TT-2P	19	TXDH-15	80	XF-9	85
TL-5/16	26	TT-3P	19	TXDH-20	80	XFD-10	83
TL-5/32	26	TT-4P	19	TXDH-25	80	XFD-15	83
TL-5/64	26	TT-5P	19	TXDH-30	80	XFD-20	83
TL-5/8	14	TT-6P	19	TXDH-40	80	XFD-6	83
TL-6	14	TT-8P	19	TXDH-6	80	XFD-8	83
TL-7/16	14	TTR-1.5	20	TXDH-7	80	XT-15	84
TL-7/32	26	TTR-1/16	20	TXDH-8	80	XT-20	84
TL-7/64	26	TTR-1/4	20	TXDH-9	80	XT-25	84
TL-8	14	TTR-1/8	20	TXDH-S6	80	XT-27	84
TL-9/16	14	TTR-10	20	TXD-S6	82	XT-30	84
TL-9/64	26	TTR-2	20	TXH-10	77	XT-40	84
TLC-1.5	12	TTR-2.5	20	TXH-15	77	XT-45	84
TLC-10	12	TTR-3	20	TXH-20	77	XT-50	84
TLC-2	12	TTR-3/16	20	TXH-25	77	XW-10	85
TLC-2.5	12	TTR-3/32	20	TXH-27	77	XW-15	85
TLC-3	12	TTR-3/8	20	TXH-30	77	XW-20	85
TLC-4	12	TTR-4	20	TXH-40	77	XW-6	85
TLC-5	12	TTR-5	20	TXH-6	77	XW-7	85
TLC-6	12	TTR-5/16	20	TXH-8	77	XW-8	85
TLC-8	12	TTR-5/32	20	TXH-S8	77	XW-9	85
TLC-S9N	12	TTR-5/64	20	TXL-10	78		
TLLB-1.5	30	TTR-6	20				
TLLB-10	30	TTR-8	20				
TLLB-2	30	TTR-S9	20				
TLLB-2.5	30	TTR-S9Z	20				
TLLB-3	30	TTS-7	19				
TLLB-4	30	TTS-9	19				
TLLB-5	30	TX-10P	78				
TLLB-6	30	TX-15P	78				
TLLB-8	30	TX-20P	78				
TLLB-S9N	30	TX-25P	78				
TLS-11	17	TX-27P	78				
TLS-13ZD	27	TX-30P	78				
TLS-6	16	TX-40P	78				
TLS-7	16	TX-45	78				
TLS-7S	16	TX-50	78				
TLS-7SD	17	TX-55	78				
TLS-7SX	15	TX-8P	78				
TLS-8	16	TXB-10	89				
TLS-8D	17	TXB-15	89				
TLS-8ZD	27	TXB-20	89				
TLS-9	16	TXB-25	89				
TLS-9D	17	TXB-27	89				
TLS-9N	14	TXB-30	89				



DATA

DATA

EXPORT

<http://www.eight-tool.co.jp>

eight tool co jp

Search



最高級六角棒スパナ

株式会社



**EIGHT TOOL CO.,LTD.**