

**EA**  
**Euro Asian Blades, Inc.**

Professional  
Diamond Tools &  
Equipment

Diamond Blades

Diamond Polishing Pads

Diamond Core Bits

Diamond Profile Bits

Floor Polishing and Finishing Tools

Material Lifting and Handling Equipment and more...

[www.diamondtoolstore.com](http://www.diamondtoolstore.com)

# Terms and Conditions

## **Pricing or Typographical Errors**

While Euro Asian Blades strives to provide accurate product and pricing information, pricing or typographical errors may occur. The Euro Asian Blades cannot confirm the price of an item until after you order. In the event that an item is listed at an incorrect price or with incorrect information due to an error in pricing or product information, The Euro Asian Blades shall have the right, at our sole discretion, to refuse or cancel any orders placed for that item. In the event that an item is mispriced, Euro Asian Blades may, at our discretion, either contact you for instructions or cancel your order and notify you of such cancellation. Prices and availability are subject to change without notice.

## **Picture Errors**

Due to everchanging design improvements, slight change in product picture to actual product you receive may be expected.

## **Order Acceptance**

Please note that there may be certain orders that we are unable to accept and must cancel. We reserve the right, at our sole discretion, to refuse or cancel any order for any reason. For your convenience, you will not be charged until your payment method is authorized, the order information is verified for accuracy and your order is shipped. Some situations that may result in your order being cancelled include limitations on quantities available for purchase, inaccuracies or errors in product or pricing information, or problems identified by our credit and fraud avoidance department. We may also require additional verifications or information before accepting any order. We will contact you if all or any portion of your order is cancelled or if additional information is required to accept your order. If your order is cancelled after your credit card has been charged, we will issue a credit to your credit card in the amount of the charge.

## **Web Site Security**

Users are prohibited from violating or attempting to violate the security of the Site, including, without limitation, (a) accessing data not intended for such user or logging onto a server or an account which the user is not authorized to access; (b) attempting to probe, scan or test the vulnerability of a system or network or to breach security or authentication measures without proper authorization; (c) attempting to interfere with service to any user, host or network, including, without limitation, via means of submitting a virus to the Site, overloading, "flooding," "spamming," "mailbombing" or "crashing;" (d) sending unsolicited email, including promotions and/or advertising of products or services; or (e) forging any TCP/IP packet header or any part of the header information in any email or newsgroup posting. Violations of system or network security may result in civil or criminal liability. You agree not to use any device, software or routine to interfere or attempt to interfere with the proper working of this site or any activity being conducted on this site. You agree, further, not to use or attempt to use any engine, software, tool, agent or other device or mechanism (including without limitation browsers, spiders, robots, avatars or intelligent agents) to navigate or search this Site other than the search engine and search agents available from Diamondtoolstore.com on this site and other than generally available third party web browsers (e.g., Netscape Navigator, Microsoft Explorer).  
Copyrights and Intellectual Property

This Site and all its Contents are intended solely for personal, non-commercial use. You may download or copy the Contents and other downloadable materials displayed on the Site for your personal use only. No right, title or interest in any downloaded materials or software is transferred to you as a result of any such downloading or copying. You may not reproduce (except as noted above), publish, transmit, distribute, display, modify, create derivative works from, sell or participate in any sale of or exploit in any way, in whole or in part, any of the Contents, the Site or any related software.

## **Product Warranty**

It is the intention of Euro Asian Blades to sell only quality products. We offer a 15 day warranty against manufacturer defects from the date of purchase. You must contact us in order to receive a RAN (Return Authorization Number). Euro Asian Blades will only replace or repair warranty items, no refunds will be given. Euro Asian Blades or the product manufacturer will inspect or test all products prior to a warranty claim adjustment. Simply returning the product to Euro Asian Blades does not guarantee payment. We do not pay for consequential, incidental and contingent damages or costs incurred of any kind, including the cost incurred directly or indirectly in relation to goods sold by Euro Asian Blades.

## **Damaged items in shipping**

If you receive an item damaged, notify the delivery person immediately. Do not discard and of the box, packing material, or broken items. You will receive replacement items. However we do require a damage claim number from U.P.S. To obtain this damage claim number call 800-742-5877. You will need to supply them with information from your shipping label. Once you have a damage claim number, call Euro Asian Blades for immediate part replacement.

## **Returns and Exchanges**

We accept returns up to 60 days on unused merchandise. All returns are subject to a 20% restocking fee.

Please contact Euro Asian Blades and obtain a Return Merchandise Authorization (RMA) number before returning any product. We are unable to accept any returns without an RMA number.



Dear Valued Customer,

We are importers and distributors with over 20 years of experience in distributing and selling only the highest quality diamond tools.

We offer a full line of diamond tools for the Marble, Granite, Stone & Construction Industries. Our product line includes diamond blades, core drill bits, grinding cup wheels, polishing discs, profile wheels and machines, and stone related chemicals.

Our diamond tools are produced using the most advanced research, development and technology. Our manufacturers only use the highest quality diamonds available in all tools they manufacture. Although many companies may offer diamond tools that appear to be the same as EA diamond tools, they will not be. Once you try EA diamond tools, you will know the difference.

Our goal is to offer our customers the finest, most reliable and durable diamond tools; while providing the most reasonable prices. EA strives for excellence to offer the best service available in this industry.

We thank you for your support in the past, present, and future and wish you success in all your endeavors.

Sincerely,

Scott Choe  
President

800-342-3876

# Showroom

Come see our showroom, located in the heart of West Palm Beach.



## Address

1335 Old Okeechobee Rd  
Suite #100  
West Palm Beach, FL 33401



## Hours

Monday to Friday  
7:30am to 5pm EST

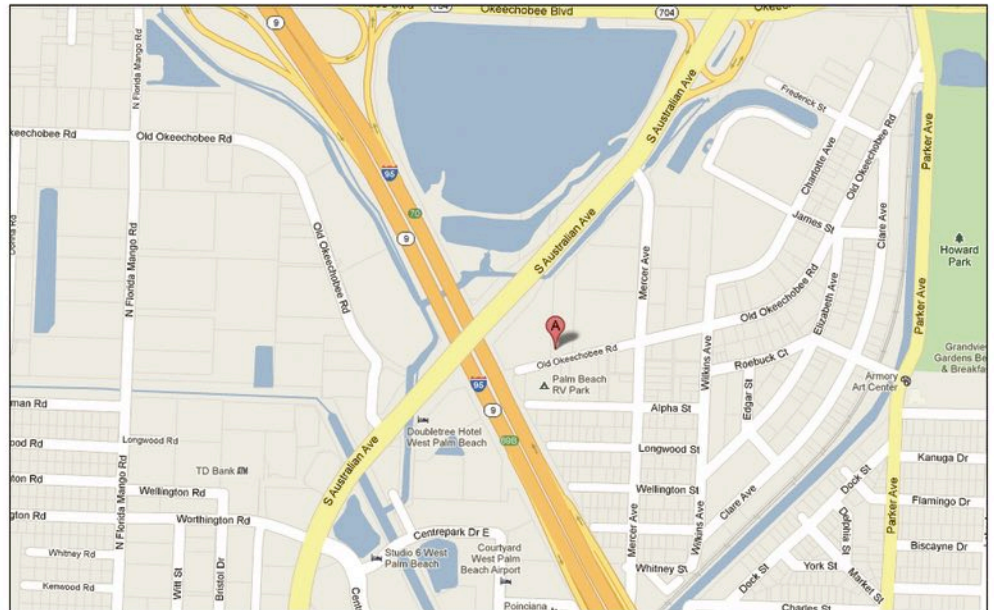

[www.diamondtoolstore.com](http://www.diamondtoolstore.com)

## Index

Diamond Blades .....	2
Rescue Blades .....	11
Diamond Core Drill Bits .....	12
Diamond Polishing Pads .....	16
Diamond Grinding Cup Wheels .....	21
Diamond Drum Wheels .....	27
Diamond Profiling Bits .....	29
Diamond CNC Bits .....	41
Stone Floor Tools .....	43
Stone Lifting & Handling .....	49
Hand Polishers & Grinders .....	69
Core Drill Machines .....	75
Stone Router Machines .....	78
Stone Cutting Saws .....	83
Concrete Grinding & Polishing .....	91
Construction Tools .....	96
Stone Care Chemicals .....	99
Accessory Parts .....	114
Miscellaneous Items .....	119
Package Deals & Specials .....	121



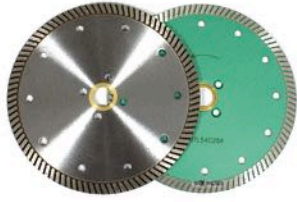

## Dia-Plus Maxima Turbo Diamond Blade

These blades are ideal for cutting hard granite. The close separation allows fast, chip free cutting. Best when used wet!  
Made in Korea

4" flat: 4 holes: 5/8" reducer.....	\$19.95
4.5" flat: 4 holes: 5/8" reducer.....	\$24.15
5" flat: 4 holes: 5/8" reducer.....	\$26.25
6" flat: 4 holes: 5/8" reducer.....	\$37.80
7" flat: 5/8" reducer.....	\$48.30
7" swirled: 8 holes: 5/8" reducer.....	\$48.30
8" swirled: 7/8" arbor: 5/8" reducer.....	\$53.90
9" swirled: 8 holes: arbor: 5/8" reducer.....	\$68.60

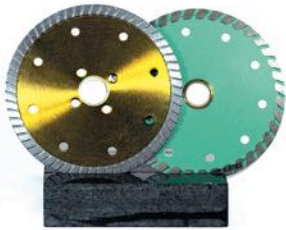

## Premium Wide Turbo Diamond Blade

This blade is a higher quality than our standard turbo blade. It is excellent for aggressive cutting of the hardest stone. Used for cutting hard marble, granite, tile, brick, refractory and ceramic products, cured or reinforced concrete.  
Made in Korea

Gold Blades: 4.5" - 7"  
Green Blades: 8" - 14"

4.5":4 holes:7/8" arbor:5/8" reducer.....	\$12.80
5":4 holes:7/8" arbor:5/8" reducer.....	\$14.40
6":4 holes:7/8" arbor:5/8" reducer.....	\$17.60
7": 7/8" arbor:5/8" reducer.....	\$22.40
8" : 7/8" arbor : 5/8" reducer.....	\$43.00
10" : 7/8" arbor : 5/8" reducer.....	\$59.00
12" : 1" arbor : 7/8" reducer.....	\$96.00
14" : 1" arbor : 7/8" reducer.....	\$113.00



## Thin-Cut Dry Super Turbo Blade

One of our most demanded blades! This unique shaped super turbo is designed for cutting all kinds of hard stones, especially for tile, porcelain, marble, and granite. This blade has extra thin segments for fast and quick dry cutting.

1.2mm x 10mm segments.  
Made in Korea

4".....	\$24.00
4.5".....	\$26.00
5".....	\$29.00



## Tuck-Point Diamond Blade

This blade has a 1/4" kerf for slotting and cutting grooves & notches in granite and all types of stone.  
Made in Korea

4".....	\$62.00
5".....	\$83.00
7".....	\$115.00



## Shark Utility/Rescue Diamond Blade

This diamond blade is perfect for cutting anything! It will cut through stone, concrete, glass, or even metal! Smaller teeth on the diamond segments makes this blade possible for cutting even wood! Custom sizes are available upon request.

Arbor : 1"/20mm

4.5".....	\$44.00
12".....	\$269.00
14".....	\$289.00



## MK TPX-40 Multi-Application Blade

MK Diamond Products' new TPX-40™ multi-application diamond blade is designed for maximum life and speed. A newly developed bond allows for cutting a wide variety of materials including brick, granite, block, pavers, concrete, bluestone and asphalt.

- NOISE REDUCTION
- COOLER CUTTING
- LONGER LIFE

TPX-40 4" x .080" x 7/8" - 168483.....	\$20.02
TPX-40 4-1/2" x .080" x 7/8" - 168484.....	\$22.31
TPX-40 5" x .080" x 7/8" - 168485.....	\$24.60
TPX-40 6" x .090" x 7/8" - 168486.....	\$32.03
TPX-40 7" x .090" x 7/8" - 168487.....	\$44.62
TPX-40 8" x .090" x 7/8" - 168488.....	\$50.91
TPX-40 9" x .090" x 7/8" - 168489.....	\$59.49
TPX-40 10" x .090" x 7/8" - 168490.....	\$68.64
TPX-40 12" x .125" x 1" - 168491.....	\$128.13
TPX-40 14" x .125" x 1" - 168492.....	\$147.00
TPX-40 16" x .125" x 1" - 168493.....	\$187.00
TPX-40 18" x .125" x 1" - 168494.....	\$225.94

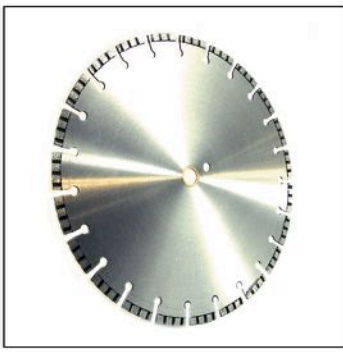

## Turbo Segmented Diamond Blade

New design cuts fast through the hard stone. This blade is laser welded for safety with a diamond height of 10mm. Use wet or dry to cut granite, concrete, and marble.

Made in Korea

10".....	\$98.00
12".....	\$132.00
14".....	\$158.00

1"-20mm Arbor

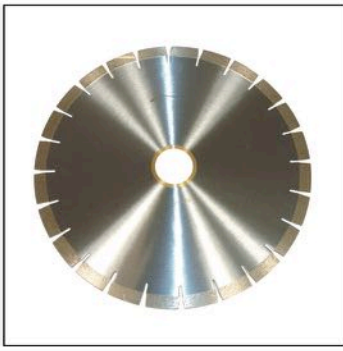

## Standard Silent-Core Blade

This blade is designed to cut granite or other hard material silently and quickly. Made to fit most common stone saws, this blade come in two different segment heights.

Made in Korea.

14" w/ 15mm segment height.....	\$111.40
16" w/ 15mm segment height.....	\$143.40
18" w/ 15mm segment height.....	\$184.00
14" w/ 20mm segment height.....	\$127.10
16" w/ 20mm segment height.....	\$165.80

Center: 50mm/60mm



## Dia-Plus Continuous Rim Blade

This dia-plus super premium heavy duty blade is of the highest quality and is also easy on the wallet. It offers extremely smooth, fast, chip free cutting. Use wet for cutting granite, slate, marble, quarry tile, hard ceramic tile, and porcelain tile.

Made in Korea

4":7/8" arbor:5/8" reducer.....	\$12.00
4.5":7/8" arbor:5/8" reducer.....	\$15.00
5":7/8" arbor:5/8" reducer.....	\$18.00
8":1" arbor:5/8" reducer.....	\$36.00
10":1" arbor:5/8" reducer.....	\$45.00
17": 50/60mm arbor.....	\$64.72

9mm Segment Height

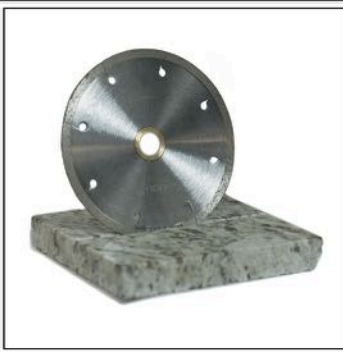

## B-Slot Marble/Granite Diamond Blade

This laser welded diamond blade is perfect for cutting on marble slabs. Made with high quality diamonds to last long.

WLSB0400 - 4"x7.0Wx2.0T Clear 7/8" -20mm-5/8"H
WLSB0500 - 5"x7.0Wx2.0T Clear 7/8" -20mm-5/8"H
WLSB0600 - 6"x7.0Wx2.0T Clear 7/8" -20mm-5/8"H
WLSB0700 - 7"x7.0Wx2.2T Clear 7/8" - DM-5/8"H
WLSB0800 - 8"x7.0Wx2.4T Clear 7/8" - DM-5/8"H

4".....	\$14.00
5".....	\$20.00
6".....	\$25.00
7".....	\$33.00
8".....	\$47.00
10".....	\$55.00





## 14 inch B Slot Diamond Blade for Blue Ripper Rail

IMPROVED! with more diamond concentration!

14".....\$176.00

Thin diamond Segments and high diamond concentration make cutting fast and smooth.

14" diameter and 50/60mm arbor.

Perfect for Marble, Porcelain, or Granite!

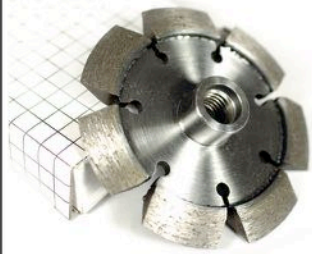

## Crack Chaser Blade

This blade is perfect for chasing cracks on slabs, especially on countertops.

Comes with regular 5/8" arbor or 5/8"-11 Thread attachment.

5/8" Arbor.....\$58.80

5/8"-11 Threaded.....\$66.78

This 5/8"-11 thread modal is a special blade, because it fits your regular hand polisher for added versatility. Both models come with 4" diameter and with high quality diamond segments.



## Contour Diamond Blade

This contour blade allows the user to cut a curved area cleanly, accurately, and safely while allowing a wider kerf.

Made in Korea

4.5".....\$70.00

5".....\$84.00



## Profiling Diamond Blade

These blades are perfect for any kind of natural stone. Perfect for sculpting. Can be used with any regular power drill.

Made in Korea

20mm.....\$40.00

30mm.....\$45.00

40mm.....\$60.00

50mm.....\$78.00

60mm.....\$92.50





## EA Electroplated Diamond Marble Blade

This dry cutting, electroplated blade may be used for all marbles. It leaves a clean, smooth cut without burns or chipping. 20mm arbor size. Made in Korea

4".....	\$28.00
4.5".....	\$30.00
5".....	\$33.00



## EA Premium Marble Diamond Blade - Brazed

This blade is perfect for cutting marble, porcelain, glass, or any other soft natural stone. No chipping, while leaving the smoothest cut. Made in Korea

4" 22mm arbor.....	\$25.00
4.5" 22mm arbor with 2mm reducer (reduce to 20mm).....	\$27.00
5" 22mm arbor with 9mm reducer.....	\$30.00
6" 22mm arbor with 9mm reducer.....	\$37.00
7" 22mm arbor, 16mm knock out.....	\$44.00
8" 22mm arbor, 16mm knock out.....	\$50.00
10" 25mm arbor with 5mm reducer (reduce to 20mm).....	\$81.00



## Exakt Diamond Blade G50

Tungsten Carbide Tipped Blade for the Exakt DC280. This blade is perfect for stone such as marble or even aluminum. Diamond Blade 110mm x G50 / Stone

4.5".....	\$14.50
-----------	---------

Diameter: ~4.5inch



## Diamond Milling Wheel

This milling wheel is designed to remove a wide amount of stone material from granite, marble, or other hard material. Designed to be used for wet applications only. Has a metal core and can be used with bridge saws or milling machines.

14".....	\$790.00
----------	----------

- Diameter: 14"
- Segments: 40mm(1-1/2")T
- Arbor: 60mm



## B-Slot Diamond Marble/Granite Blade

This laser welded diamond blade is perfect for cutting on marble slabs. Made with high quality diamonds to last long.

4".....	\$14.00
5".....	\$20.00
6".....	\$25.00
7".....	\$33.00
8".....	\$47.00
10".....	\$55.00

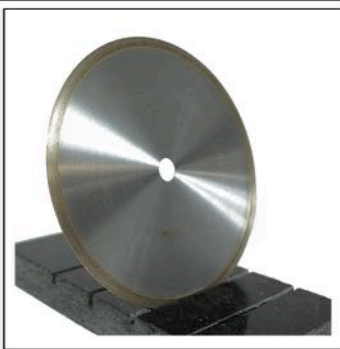

## EA Glass Blade

This ultra thin continuous blade is designed for cutting glass with a smooth finish. High quality diamond in this made make it a durable, long-lasting blade compared to others in the market.

4".....	\$31.00
5".....	\$40.00
7".....	\$43.00
8".....	\$47.00
10".....	\$65.00

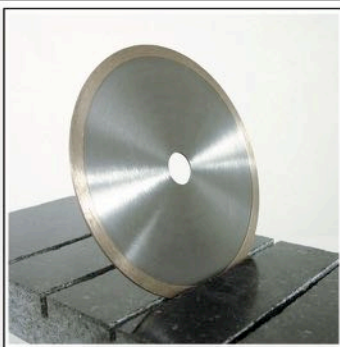

## Standard Continuous Rim Blade

This continuous blade is perfect for cutting tile. Thin, but 5mm width of diamond segments will cut through tile smoothly and easily. 7/8" and 5/8" arbor size makes this blade fit most of the saws in the market.

4".....	\$5.00
4.5".....	\$8.00
8".....	\$12.00

Very Aggressively Priced! Highest Value for Money!



## MK-225 Hot Dog Blade

Premium grade wet only, thin-rim blade for porcelain & vitreous tile. The MK-225 Hot Dog blade has tension slots to prevent dishing and blade wobble. Diamond blade utilizes Micro Bead technology and a patent pending core slot design to provide a thin kerf, ensuring a consistent cutting edge and eliminating porcelain surface chipping even with the hardest porcelain tile. Standard arbor size fits all tile saws.

Hot Dog Diamond Blade is ideal for wet cutting of porcelain, vitreous and ceramic tile. Cuts 10% faster and lasts 20% longer than standard blades. Eliminates porcelain surface chipping.

4".....	\$29.95
4.5".....	\$31.95
5".....	\$35.25
6".....	\$40.60
7".....	\$47.80
8".....	\$55.85
10".....	\$65.83
12".....	\$103.99



# Delivery Service

Available  
Upon Request

800-342-3876



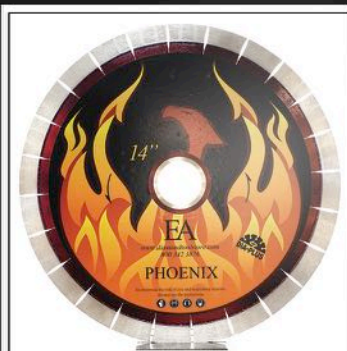

## Array Pattern Diamond Granite & Engineered Stone

Traditionally, fast-cutting diamond blades did not have a long life-span, and long-lasting blades did not cut fast. Long life and fast cutting speed were incompatible. Now, both fast cutting speed and long life exist in the same diamond blade - the Arrayed Pattern Diamond Blade.

"We still love the blade. It has increased our production time by about 40%."

Jeremiah Rivers  
Rivers Edge Countertops



**\*Double Performance\***  
Diamond arranged segment for long life and copper line for excellent cutting. So Only one for double performance is dialix type saw blade.

**\*Long life Performance\***  
Diamond arranged segment saw blade for long life. Diamond put on the segment one by one from 2nd layers to 10 layers.

- 14" - 20mm - Silent Core.....\$216
- 16" - 20mm - Silent Core.....\$252
- 18" - 20mm Silent Core.....\$316



## Array Pattern Diamond Construction Blade

The new 'ARRAY' pattern is the best revelation in cutting stone up to date. Perfect for construction work for cutting concrete and other hard material.

14".....\$135.20

Application: Hard/Soft concrete, concrete w/ rebar, brick, pavers, block, stone, roof tile, asphalt.



## 14" Array Pattern Blade for Blue Ripper Rail Saw

New technology blade for the popular Omega Blue Ripper Rail saw.

14"-10mm - Standard Core .....\$151.20

Application: Granite & other stones

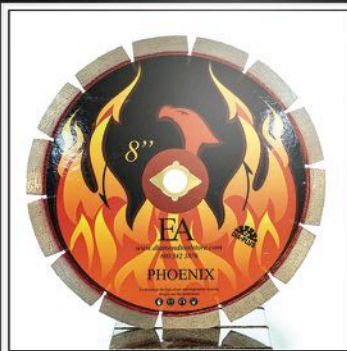

## 8" Array Pattern Blade for Blue Ripper Junior Saw

New technology blade for Blue Ripper Junior Rail saw from Omega Diamond

8"-10mm-Standard Core.....\$63.20

Application: Granite & other stones





## MK Diamond TX-30 Professional Porcelain Blade

The TX Blade Series have a 1" arbor that differentiates them from typical wet cutting tile blades available in the market. Please note: standard 5/8" Arbor Tile Blades will NOT Fit the TX-3 tile saw.

TX-30 offers a thicker kerf version of MK Diamond's popular Hot Dog blade. The unique "J" cooling slots deliver fast, "chip free" cutting of porcelain tile and other hard dense materials.

Diameter:10"(254mm),Width:0.060,Arbor:1",TX-30:166967,Rim Height:8mm.....\$85.00



## MK Diamond TX-40 Professional Tile/Stone Blade

TX-40 delivers what you'd expect from a top of the line diamond blade. This is MK Diamond's very best for cutting tile & stone. From marble to granite, you can count on the TX-40 to get the job done. The thicker blade kerf and high rim height makes it the ideal choice for jobs that require miter cutting. The TX Blade Series have a 1" arbor that differentiates them from typical wet cutting tile blades available in the market. Please note: standard 5/8" Arbor Tile Blades will NOT Fit the TX-3 tile saw.

Diameter:10"(254mm),Width:0.080,Arbor:1",TX-40:166968,Rim Height:10mm.....\$100.00



## MK Diamond TX-50 Premium Glass Blade

TX-50 is simply the best all around glass blade on the market. This diamond matrix formulation for cutting glass produces consistent results time after time. Often glass cutting requires regular "dressing" to remove debris from the rim of the blade. Use of a MK Diamond dressing stone (#152792) will help you get the best performance and life from your TX-50 blade. The TX Blade Series have a 1" arbor that differentiates them from typical wet cutting tile blades available in the market. Please note: standard 5/8" Arbor Tile Blades will NOT Fit the TX-3 tile saw.

Diameter:10"(254mm),Width:0.060,Arbor:1",TX-50:166969,Rim Height:7mm.....\$100.00



## MK Diamond TX-20 Premium Tile Blade

The TX Blade Series have a 1" arbor that differentiates them from typical wet cutting tile blades available in the market. Please note: standard 5/8" Arbor Tile Blades will NOT Fit the TX-3 tile saw.

TX-20 provides dependable performance and long life when cutting ceramic tile and marble.

Diameter:10"(254mm),Width:0.060,Arbor:1",TX-20:166966,Rim Height 7mm.....\$85.00



## EA Diamond Construction Blade

These durable blades offer top performance, long life and excellent value for masonry, bricks, pavers, block, cured concrete, green concrete, and asphalt.

Made in Korea

12".....	\$132.00
14".....	\$159.00
16".....	\$195.00
18".....	\$246.00

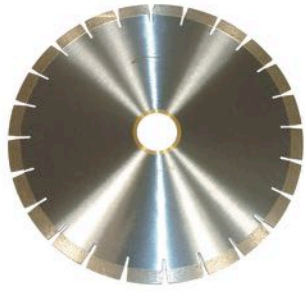

## Standard Silent-Core Blade

This blade is designed to cut granite or other hard material silently and quickly. Made to fit most common stone saws, this blade come in two different segment heights. Made in Korea.

Center: 50mm/60mm

14" 15mm.....	\$199
16" 15mm.....	\$239
18" 15mm.....	\$320



## MK CX-10 Cured Concrete Blade

Premium Grade for Cured Concrete.

12"(305mm), Width:0.100, Arbor:1".....	\$147.58
14"(356mm), Width:0.125, Arbor:1".....	\$177.89



## MK-7710W Pro Blade

The MK-Pro Series is designed and engineered for use on high horsepower, flat saws. This Professional Series is for contractors who insist on optimal performance. All Pro Series blades are available in a variety of bond hardnesses to assure maximum performance no matter what your job.

12"(305mm), Width:0.125, Arbor:1".....	\$538.31
14"(356mm), Width:0.125, Arbor:1".....	\$744.74
14"(356mm), Width:0.145, Arbor:1".....	\$800.23
16"(406mm), Width:0.125, Arbor:1".....	\$1,440.30
18"(457mm), Width:0.125, Arbor:1".....	\$966.11
18"(457mm), Width:0.155, Arbor:1".....	\$1,138.28
20"(508mm), Width:0.125, Arbor:1".....	\$1,057.63
24"(610mm), Width:0.145, Arbor:1".....	\$1,215.50
30"(762mm), Width:0.187, Arbor:1".....	\$2,479.62





## MK-7601W Green Pro Blade

The MK-Pro Series is designed and engineered for use on high horsepower, flat saws. This Professional Series is for contractors who insist on optimal performance. All Pro Series blades are available in a variety of bond hardnesses to assure maximum performance no matter what your job

Brazed segments on blades over 24" diameter

12"(305mm),	Width:0.125,	Arbor:1"	.....	\$604.03
14"(356mm),	Width:0.125,	Arbor:1"	.....	\$700.13
14"(356mm),	Width:0.145,	Arbor:1"	.....	\$801.94
18"(457mm),	Width:0.125,	Arbor:1"	.....	\$814.53
18"(457mm),	Width:0.155,	Arbor:1"	.....	\$996.42
20"(508mm),	Width:0.155,	Arbor:1"	.....	\$1,189.65
24"(610mm),	Width:0.155,	Arbor:1"	.....	\$1,367.65
30"(762mm),	Width:0.187,	Arbor:1"	.....	\$1,686.83



## MK 7501 Concrete Blade

MK-7501- For cured concrete with hard aggregate/non-abrasive sand

The MK-Pro Series is designed and engineered for use on high horsepower, flat saws. This Professional Series is for contractors who insist on optimal performance. Pro Series blades are available in a variety of bond hardnesses to assure maximum performance.

Brazed segments on blades over 24" diameter

12"(305mm),	Width:0.125,	Arbor:1"	.....	\$576.58
14"(356mm),	Width:0.125,	Arbor:1"	.....	\$679.54
16"(406mm),	Width:0.125,	Arbor:1"	.....	\$793.36
18"(457mm),	Width:0.125,	Arbor:1"	.....	\$896.32
18"(457mm),	Width:0.155,	Arbor:1"	.....	\$1,123.98
20"(508mm),	Width:0.125,	Arbor:1"	.....	\$1,030.74
24"(610mm),	Width:0.155,	Arbor:1"	.....	\$1,328.18
24"(610mm),	Width:0.187,	Arbor:1"	.....	\$1,525.52
26"(660mm),	Width:0.155,	Arbor:1"	.....	\$1,503.79
30"(762mm),	Width:0.187,	Arbor:1"	.....	\$2,058.06
36"(914mm),	Width:0.187,	Arbor:1"	.....	\$2,889.17



## MK 7502 Concrete Blade

MK-7502 - For cured concrete with medium-hard aggregate

The MK-Pro Series is designed and engineered for use on high horsepower, flat saws. This Professional Series is for contractors who insist on optimal performance. Pro Series blades are available in a variety of bond hardnesses to assure maximum performance.

Brazed segments on blades over 24" diameter

12"(305mm),	Width:0.125,	Arbor:1"	.....	\$576.58
14"(356mm),	Width:0.125,	Arbor:1"	.....	\$610.32
14"(356mm),	Width:0.155,	Arbor:1"	.....	\$830.54
16"(406mm),	Width:0.125,	Arbor:1"	.....	\$712.14
18"(457mm),	Width:0.125,	Arbor:1"	.....	\$896.32
18"(457mm),	Width:0.155,	Arbor:1"	.....	\$1,123.98
18"(457mm),	Width:0.187,	Arbor:1"	.....	\$1,283.00
20"(508mm),	Width:0.125,	Arbor:1"	.....	\$940.37
20"(508mm),	Width:0.155,	Arbor:1"	.....	\$1,469.89
24"(610mm),	Width:0.155,	Arbor:1"	.....	\$1,460.89
26"(660mm),	Width:0.175,	Arbor:1"	.....	\$1,897.90
30"(762mm),	Width:0.175,	Arbor:1"	.....	\$2,538.54



## MK 7503 Concrete Blade

MK-7503 - For cured concrete with soft aggregate/abrasive sand

The MK-Pro Series is designed and engineered for use on high horsepower, flat saws. This Professional Series is for contractors who insist on optimal performance. Pro Series blades are available in a variety of bond hardnesses to assure maximum performance.

Brazed segments on blades over 24" diameter

12"(305mm),	Width:0.125,	Arbor:1"	.....	\$693.84
14"(356mm),	Width:0.125,	Arbor:1"	.....	\$816.24
14"(356mm),	Width:0.155,	Arbor:1"	.....	\$1,002.72
18"(457mm),	Width:0.125,	Arbor:1"	.....	\$920.35
18"(457mm),	Width:0.155,	Arbor:1"	.....	\$1,119.40
20"(508mm),	Width:0.125,	Arbor:1"	.....	\$1,278.42
24"(610mm),	Width:0.155,	Arbor:1"	.....	\$1,558.13
26"(660mm),	Width:0.175,	Arbor:1"	.....	\$1,808.66





## Phoenix Blade

We are direct distributors for the manufacturer of the newest type of 14-inch diamond rescue blade, the Phoenix Blade, for use on all types of rescue saws. This blade cuts chains, locks, rock, concrete, wire fencing, re-bar, steel, car hoods, safety glass, asphalt – anything that gets in its way! Because there is no "middleman", our prices are extremely competitive; our quality is unequalled.

Unlike other diamond rescue blades, in which the diamond segments are "laser-welded" to the blade core, our blade has the diamond chips adhered directly to the blade core substrate under extremely high pressure in a specialized hydrogen furnace, combined with a high-technology vacuum brazing process. The result is 30% more diamond exposure, making this the fastest-cutting rescue blade available anywhere in the world, with minimal sparking, and up to 100 times longer life than a standard rotary-saw carbide blade.

Made in Korea

12" .....	\$269
14" .....	\$289
16" .....	\$389



## Shark Utility/Rescue Diamond Blade

This diamond blade is perfect for cutting anything! It will cut through stone, concrete, glass, or even metal! Smaller teeth on the diamond segments makes this blade possible for cutting even wood! Custom sizes are available upon request.

Arbor : 1 7/20mm

4.5" .....	\$44.00
12" .....	\$269.00
14" .....	\$289.00



## MK Fire Tiger Tooth Blade

The Fire Tiger Tooth diamond blade is engineered for use by Fire Fighters, Rescue, USAR, S.W.A.T. and Police. Applications include utilization as an Emergency Rescue Blade and Tactical Entry Tool.

MK Diamond's new Vacuum Brazed Technology is the secret to the Fire Tiger Tooth's effectiveness. Diamond particles are fused directly to the steel core creating the strongest heat resistant bond available when cutting without water cooling. Available in the most popular sizes, the Fire Tiger Tooth can be employed on hand-held grinders, circular saws, chop saws and gas cutoff saws.

Sizes: 4", 4.5", 7", 12", 14", 16

Call for prices



## MK TPX-40 Multi-Application Blade

MK Diamond Products' new TPX-40TM multi-application diamond blade is designed for maximum life and speed. A newly developed bond allows for cutting a wide variety of materials including brick, granite, block, pavers, concrete, bluestone and asphalt.

Sizes: 4", 4.5", 5", 6", 7", 8", 9", 10", 12", 14", 16", 18"

Call for prices



## Dry Core Drill Bit

50% OFF On 1-1/4 Size. Alligator Special!

Perfect for drilling granite, concrete, or any other hard stone. This diamond drill bit is especially made to use without water for convenient use in situations such as drilling inside a house hold. Comes with 5/8"-11 threaded attachment. Made in Korea

Total Length: 4"  
Cutting Length: 2-3/4"

1-1/4".....	\$43.20
1-3/8".....	\$90.00



## EA Dry Segmented Core Drill Bit

NEW LOWER PRICING!!

These diamond drill bits are perfect for drilling on granite or any other hard stone. These core bits are made to use dry, making it easier to use on smaller applications where water cannot be used. Special design cuts in to stone smoother and makes the bit last long. These bits have standard 5/8-11 thread attachment. Made in Korea

Currently only available in 70mm.

1".....	\$39.00
1-1/4".....	\$43.00
1-3/8".....	\$46.00
1-1/2".....	\$52.00
1-3/4".....	\$58.00
2".....	\$63.00



## EA Continuous & Side Protected Drill Bit

Our cleanest and smoothest cutting granite drill bit!

Used on granite or any other hard stones with or without water. Special wave pattern make a clean, fast, and effective cut. Side Diamonds provide smoother sidewall and faster drilling. Made in Korea

Comes with a user friendly 5/8"-11 female thread.

Total Length: 3"  
Cutting Length: 3/4"

1-1/4".....	\$66.00
1-3/8".....	\$69.30



## Continuous Core Drill Bit

50% OFF On 1-1/4 Size. Alligator Special!

Our cleanest and smoothest cutting granite drill bit!

Used on granite or any other hard stones with or without water. Special wave pattern make a clean, fast, and effective cut. Made in Korea

Comes with a user friendly 5/8"-11 female thread.

Total Length: 3" - 3-1/2"  
Cutting Length: 1-3/4"

1".....	\$55.00
1-1/4".....	\$30.00
1-3/8".....	\$63.00
1-1/2".....	\$65.00
1-5/8".....	\$69.00
1-3/4".....	\$75.00
1-7/8".....	\$80.00



## Segmented Drill Bit for Granite

50% OFF on 5/8" and 1-3/8" Sizes. Alligator Special!

Our most aggressive drill bit for granite, concrete or any other hard stone. Dia-Plus diamond core drill bits are for use with water. Comes with a user friendly 5/8"-11 female thread. Made in Korea

Total Length: 5"  
Cutting Length: 3-3/4"

3/16".....	\$50.00	1-3/4".....	\$99.00
1/4".....	\$53.00	1-5/8".....	\$95.00
3/8".....	\$57.00	1-7/8".....	\$102.00
1/2".....	\$64.00	2".....	\$107.00
5/8".....	\$39.00	2-1/4".....	\$112.00
3/4".....	\$71.00	2-1/2".....	\$119.00
7/8".....	\$73.00	3".....	\$135.00
1".....	\$75.00	3-1/4".....	\$143.00
1-1/8".....	\$77.00	3-1/2".....	\$150.00
1-1/4".....	\$79.00	4".....	\$185.00
1-3/8".....	\$42.50	4-3/8".....	\$200.00
1-1/2".....	\$92.00		





## Segmented & Side Protected Drill Bit

NEW LOW PRICE!!

Ideal bit for drilling granite, concrete, or any other hard stones. Brazed, side diamonds in these stone drill bit provide improved drilling and smoother sidewall. Comes with a user friendly 5/8" -11 thread. Wet use only! Made in Korea

1".....	\$33.60
1-1/4".....	\$36.30
1-3/8".....	\$39.10
1-1/2".....	\$42.90
1-3/4".....	\$48.00
1-5/8".....	\$45.00
2".....	\$52.30

Total Length: 3" / 5-3/8"



## Brazed Core Drill Bit for Marble

Smoothest cutting drill bit for soft stones. Comes with a user friendly 5/8" -11 thread. Application: marble, tile, glass, porcelain. Made in Korea

1/4".....	\$33.00
3/8".....	\$36.00
1/2".....	\$37.00
7/8".....	\$44.00
1".....	\$45.00
1-1/4".....	\$47.00
1-3/8".....	\$48.00
1-1/2".....	\$49.00
1-3/4".....	\$53.00
1-5/8".....	\$51.00
2".....	\$59.00

Total Length: 3-1/8"  
Cutting Length: 1-3/4"



## Brazed with Long Shank Drill Bit

3/8" Shank 2-1/2" Long. Application: marble, tile, glass, porcelain. Brazed side diamonds provides improved drilling and smoother sidewall. Made in Korea

1".....	\$49.00
1-1/4".....	\$52.00
2".....	\$64.00
2-1/2".....	\$82.00
3-1/8".....	\$102.00

Total Length: 3"  
Cutting Length: 2-1/4"



## Brazed with Side Protection Drill Bit

Comes with a user friendly 5/8" -11 thread and side protection. Brazed side diamonds provides improved drilling and smoother sidewall. Made in Korea. Application: marble, tile, glass, porcelain and other soft stones.

3/4".....	\$37.60
1".....	\$39.20
1-1/4".....	\$41.60
1-3/8".....	\$44.00
1-1/2".....	\$46.40
1-3/4".....	\$48.80
2".....	\$51.20
2-3/8".....	\$63.20
2-1/2".....	\$65.60

Total Length: 2-7/8"  
Cutting Length: 2"



## Diamond Non-Core Drill Bit

For anchor/blind hole applications. Made in Korea

3/16".....	\$50.00
1/4".....	\$53.00
8mm.....	\$44.00
10mm.....	\$49.00
12mm.....	\$54.00

Total Length: 3-3/8"  
Cutting Length: 2"





## Construction Core Drill Bit

For use with masonry, brick, block, & cured concrete. Excellent bits!! They cut aggressively, will last a long time, and are easy on the wallet! All of these bits are 15" long with a 1 1/4"-7 thread. It will fit a Milwaukee drill. Not for use with marble or granite. Made in Korea  
NOTE: (1" and 1 1/2" - come with 5/8" - 11 thread)

Total Length: 16"  
Cutting Length: 13-1/2"

1".....	\$85.00
1-1/2".....	\$89.00
2".....	\$97.00
2-1/2".....	\$119.00
3".....	\$139.00
3-1/2".....	\$159.00
4".....	\$177.00
4-1/2".....	\$198.00
5".....	\$233.00

## Your Safety When Using Diamond Tools

**WARNING:** Comply with all cautions and warning provided by the saw manufacturer. All diamond blades should be used in compliance with ANSI Safety Code B7.1: Wear eye protection, examine all machinery and equipment for beginning operation and handle ALL equipment and machinery according to the manufacturer's regulations.

**WARNING:** Careless or improper use of a diamond blade could cause personal injury. Observe the following precautions and tool manufacturer's instructions for using tools and diamond blades.



1. Before use, examine all blades for cracks and other damage. Do not use if damage is suspected. Damaged, incorrectly mounted and/or misused blades are extremely dangerous to use.
2. Always wear proper safety equipment i.e. safety footwear, safety goggles, snug fitting clothing, hearing and head protection and proper respiratory equipment.
3. Always use wheel guard and check for proper function of all guards on the tool. Never pull guards back, remove them, or leave them in open position.
4. Be sure that the arrow on the blade points in the same direction of rotation of the tool.
5. Be sure that the blade washers/flanges are correctly assembled on the shaft and that the blade is properly supported. Do not use blades that rattle or wobble on the tool.
6. Do not alter the hold in the blade. This creates an unbalanced blade rotation resulting in wobbling, pounding or cracking which is hazardous.
7. Inspect flanges for warpage, cleanliness, burrs, and flatness.
8. For safe operation, use flanges which are at least 1/4 diameter of the blade.
9. Make sure the no-load RPM on the tool's name plate does not exceed the speed marked on the blade.
10. Before performing any cutting operations let the tool run for few seconds without load. If the blade wobbles, vibrates or unusual noise occurs, stop the tool immediately. Examine the blade for damage or incorrect mounting.
11. Do not stand in line with the blade or the stream of hot particles.
12. Keep bystanders and/animals out of the work space.
13. Maintain a firm grip on the tool during cutting operation.
14. Slow feed speeds are recommended. Do NOT force the tool.
15. The diamond blade is intended for straight line cutting only. Cutting curves will cause stress cracks for fragmentation on the blade, resulting in possible injury to people in the vicinity.
16. Do not use side pressure or grind with the side of the diamond blade.
17. Examine blades carefully before each use for proper alignment and possible defects.
18. Make sure all users of the blade comply with safety regulations.

MK Diamond Products Inc., an American, family-owned company since 1868, is a recognized world leader in the manufacturing of equipment for cutting, coring, and polishing all types of masonry, concrete, tile, and stone products.



**MK Diamond Products, Inc.**

## Floor Machines



**MK-VTS-50**  
Floor Scraper



**DDG-11** Double  
Disc Grinder



**SG-9**  
Scarifier

## Blades



**MK-205** Dry  
Turbo Blade



**MK-62M**  
Wet Segmented  
Blade

**MK T-Segment**  
Contour Blade



## Cup Wheels



**MK-304CG** Cup Wheel



**T-Segment**  
Cup Wheel



**MK-704SG-2**  
Bi-Turbo Cup Wheel

## Saws



**MK-101**  
Tile & Stone Saw



**CX-3H**  
Concrete Saw



**MK-1590**  
Rail Saw



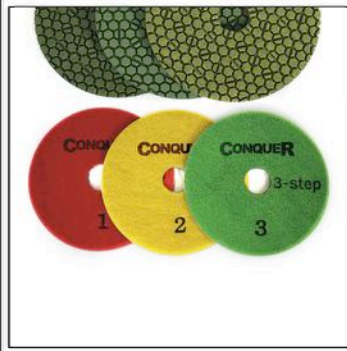

## Conquer 3-Step Polishing Pads

\*THE CONQUER PADS NOW HAVE NEW IMPROVED HOOK AND LOOP FOR STRONGER MORE DURABLE HOLD\*

EA Diamond Tools and Machines introduces the undisputed king of wet polishing pads, new technology in stone polishing!

The Conquer 3-Step Wet Polishing Pad System is revolutionizing the way that stone fabricators polish stone. Say farewell to 7-step polishing forever!

Step-1.....	\$22.20
Step-2.....	\$22.20
Step-3.....	\$22.20



## Conquer Pads with Snail Lock Backing

This package combines our best selling Conquer 3-Step Polishing Pads with Snail-Lock backing for those who prefer it.

The Conquer 3-Step Wet Polishing Pad System is revolutionizing the way that stone fabricators polish stone. Say farewell to 7-step polishing forever!

Step-1 .....	\$31.50
Step-2 .....	\$31.50
Step-3 .....	\$31.50



## Dia-Plus Premium Diamond Polishing Pads

These resin polishing pads are the best quality of polishing pads we carry at Diamond Tool Store up-to-date. These are perfect for granite, marble, or any other natural stones with water. Since these pads have the best quality diamonds and high concentration of diamonds, we guarantee best quality and long lasting durability! We recommend 1500 to 4500 rpms with hand held polishers and ~175rpm with floor polishers.

Type: Flexible resin with adhesive back.

3", Grit:50.....	\$22.50
3", Grit:100,200,400,800,1500,3000.....	\$20.50
3", Buff-Black.....	\$25.00
4", Grit:50.....	\$26.50
4", Grit:100,200,400,800,1500,3000.....	\$24.50
4", Buff-Black.....	\$29.00
5", Grit:50.....	\$35.50
5", Grit:100,200,400,800,1500,3000.....	\$33.50
5", Buff-Black.....	\$38.00



## EA Premium Diamond Polishing Pads

These polishing discs, with a diamond thickness of 3.5mm, is among the very best available. This disc is specially formulated for maximum flexibility, making it the best choice for polishing serps and ovals. Use wet. With hand-held grinders- 1,500 to 4,500 RPM. With floor machine - 175 rpm  
Made in Korea

Available in 4" only

Grit:50.....	\$15.20
Grit:100.....	\$15.20
Grit:200.....	\$15.20
Grit:400.....	\$15.20
Grit:800.....	\$15.20
Grit:1500.....	\$15.20
Grit:3000.....	\$15.20



## EA Standard Diamond Polishing Pads

These flexible diamond pads are the best value for your money! Comes in 4 inch and can be used on granite, marble, concrete, or any other stone with water.

4", Grit:50,100,200,400,800,1500,3000.....	\$9.00
5", Grit:50,100,200,400,800,1500,3000.....	\$16.00





## Amigo Diamond Polishing Pads

AMAZING NEW LOW PRICE!!!

Limited quantities and while supplies last.

These flexible diamond pads are the best value for your money! Comes in 4 inch and can be used on granite, marble, concrete, or any other stone with water. Made in Korea

Grit:50 .....	\$4.00
Grit:100 .....	\$4.00
Grit:200 .....	\$4.00
Grit:400 .....	\$4.00
Grit:800 .....	\$4.00
Grit:1500 .....	\$4.00
Grit:3000 .....	\$4.00



## EA Dry Polishing Pads

ALLIGATOR SPECIAL

These EA Dry Pads are perfect for indoor fabrication projects. Manufactured to be used without water. They are perfect for granite, marble, or any other natural stones. These pads are to give highest quality results without high price!

4 inch flexible

Grit:50 .....	\$9.50
Grit:100 .....	\$9.50
Grit:200 .....	\$9.50
Grit:400 .....	\$9.50
Grit:800 .....	\$9.50
Grit:1500 .....	\$9.50
Grit:3000 .....	\$9.50
Buff White .....	\$10.50
Buff Black .....	\$10.50



## Dia-Plus 4 Inch Dry Diamond Polishing Pads

Dia-Plus dry flexible pads are designed for polishing granite or marble without water. These dry flexible pads are great for on the job touch-up and polishing when a wet application is just not possible. Made in Korea

Grit:50 .....	\$18.40
Grit:100 .....	\$17.60
Grit:200 .....	\$17.60
Grit:400 .....	\$17.60
Grit:800 .....	\$17.60
Grit:1500 .....	\$17.60
Grit:3000 .....	\$17.60
Buff White .....	\$20.00
Buff Black .....	\$20.00



## Premium Concrete Polishing Pads

Perfect pads for polishing concrete. These pads are made with high quality diamonds and backing that last longer than other concrete pads in the market. Smooth flexibility in these make polishing rounded or curved areas easier than before. Our highest quality pads for concrete!

4" flexible

Grit:50 .....	\$19.50
Grit:100 .....	\$19.50
Grit:200 .....	\$19.50
Grit:400 .....	\$19.50
Grit:800 .....	\$19.50
Grit:1500 .....	\$19.50
Grit:3000 .....	\$19.50
Buff White .....	\$23.02
Buff Black .....	\$23.02



## Triangular Dry Polishing Pads

These triangular pads are perfect for using on oscillating hand polishers. Made for granite, marble or any other stone material. Makes corner polishing/buffing easy with kitchen countertop fabrication.

Grit:50 .....	\$10.30
Grit:100 .....	\$10.30
Grit:200 .....	\$10.30
Grit:400 .....	\$10.30
Grit:800 .....	\$10.30
Grit:1500 .....	\$10.30
Grit:3000 .....	\$10.30

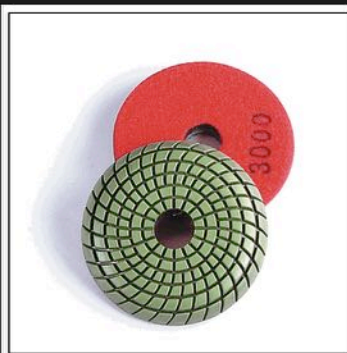

## Dia-Plus Convex Diamond Polishing Pads

This ingenious new design is the fastest and most economical way to polish ogee and concave edges on stone countertops. They can also be used to easily correct lip-page, when using a floor machine.  
Made in Korea

3", Grid:50 .....	\$27.00
3", Grid:100,200,400,800,1500,3000 .....	\$25.00
3", Buff White .....	\$29.00
3", Buff Black .....	\$29.00
4", Grid:50 .....	\$34.00
4", Grid:100,200,400,800,1500,3000 .....	\$32.00
4", Buff White .....	\$38.00
4", Buff Black .....	\$38.00

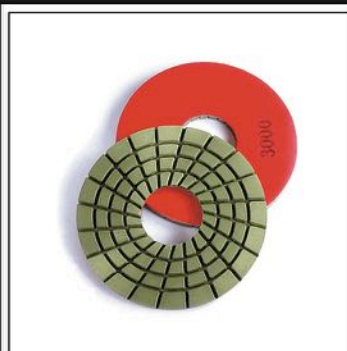

## Dia-Plus Rigid Diamond Polishing Discs

Made for Granite or Marble Floors. Wet application.  
Made in Korea

5", Grid:50 .....	\$58.00
5", Grid:100,200,400,800,1500,3000 .....	\$56.00
5", Buff White .....	\$70.00
5", Buff Black .....	\$70.00
7", Grid:50 .....	\$71.00
7", Grid:100,200,400,800,1500,3000 .....	\$69.00
7", Buff White .....	\$83.00
7", Buff Black .....	\$83.00



## Diamond Floor Polishing Pads for Marble: 3"

Used on Marble with floor machine. 10mm thickness!  
Made in Korea

Grid:50 .....	\$25.00
Grid:100 .....	\$22.00
Grid:200 .....	\$22.00
Grid:400 .....	\$22.00
Grid:800 .....	\$22.00
Grid:1500 .....	\$22.00
Grid:3000 .....	\$22.00

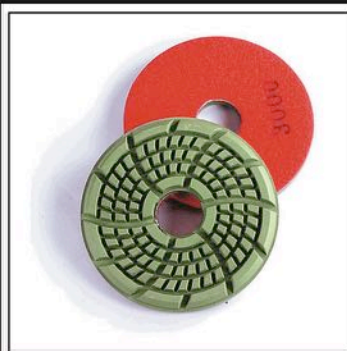

## Diamond Floor Polishing Pads for Granite - 3.5 inch

Use for granite with a floor machine.  
Made in Korea

Grid:50 .....	\$31.00
Grid:100 .....	\$29.00
Grid:200 .....	\$28.00
Grid:400 .....	\$28.00
Grid:800 .....	\$28.00
Grid:1500 .....	\$28.00
Grid:3000 .....	\$28.00
Buff White .....	\$43.00
Buff Black .....	\$43.00

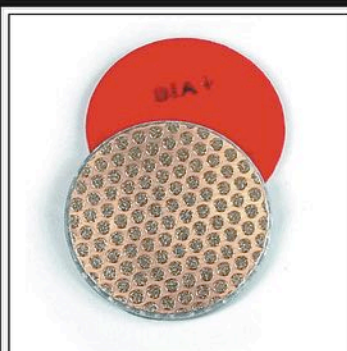

## Electroplated 3" Rigid Honing Disc

Use with a floor machine to hone marble, travertine, and other soft stones.  
Made in Korea.

Grid:50 .....	\$21.00
Grid:100 .....	\$18.00
Grid:200 .....	\$18.00
Grid:400 .....	\$18.00

(for extra thick palstic, add \$7.00)





## Diamond Vitrified Discs

These discs are specifically designed to handle the hard job of removing saw marks and grinding marks in order to prepare the stone for polishing. Comes in 4 inch size. Made in Korea

Grit:60.....	\$38.00
Grit:150.....	\$38.00
Grit:300.....	\$38.00



## Resin Snail Lock Pads

Made in Korea

4", Grit:50 .....	\$42.00
4", Grit:100,200,400,800,1500,3000 .....	\$39.00
5", Grit:50 .....	\$62.00
5", Grit:100,200,400,800,1500,3000 .....	\$59.00

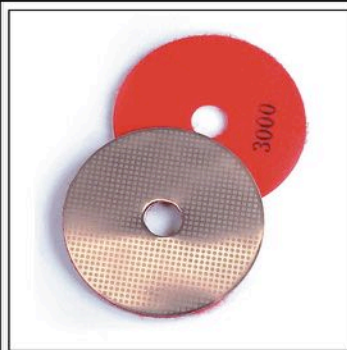

## Flexible Diamond Honing Disc: 4" Electroplated

Use on marble and other soft stones. These pads should be used dry up to 10,000 rpms. Made in Korea

Grit:50.....	\$29.00
Grit:100.....	\$29.00
Grit:200.....	\$29.00
Grit:400.....	\$25.00
Grit:800.....	\$25.00
Grit:1500.....	\$25.00
Grit:3000.....	\$25.00



## Diamond Hand Pads: Electroplated

For use on marble & other soft stones. Made in Korea

Grit:50.....	\$17.00
Grit:100.....	\$15.00
Grit:200.....	\$13.00
Grit:400.....	\$12.00
Grit:800.....	\$12.00
Grit:1500.....	\$12.00
Grit:3000.....	\$12.00



## Diamond Polishing Sheets

These Electro-Plated diamond polishing sheets are perfect for all your stone polishing needs. Works great on marble, granite, and other stones. Adhesive-back (PSA) allows you to stick these pads to any polisher, device, or container you want. Since you can cut these with scissors to any shape you want, versatility is unbeatable.

Dimensions: 8" x 12"  
Peel-Off Self-Adhesive Back (PSA)

Grit:50.....	\$125.00
Grit:100.....	\$125.00
Grit:200.....	\$125.00
Grit:400.....	\$125.00
Grit:800.....	\$125.00
Grit:1500.....	\$125.00
Grit:3000.....	\$125.00



## Resin Radial Arm Polishing Disc

Use this Dia-Plus resin polishing disc on your radial arm machine for fast and easy grinding and polishing of marble or granite.

Made in Korea

6", Grid:50,100,200,400,800,1500,300.....	\$42.00
6", Buff White.....	\$79.00
6", Buff Black.....	\$79.00
10", Grid:50,100,200,400,800,1500,300.....	\$97.00
10", Buff White.....	\$134.00
10", Buff Black.....	\$134.00



## Metal Radial Arm Polishing Disc

Use this Dia-Plus metal grinding disc on your radial arm machine for fast and effective grinding and stock removal on marble or granite. Prepares stone for polishing.

Made in Korea

6", Grit:50/60.....	\$150.00
6", Grit:100,200,400.....	\$105.00
10", Grit:50/60.....	\$205.00
10", Grit:100,200,400.....	\$160.00



## Premium Metal Radial Arm Polishing Disc

Use this Dia-Plus metal grinding disc on your radial arm machine for fast and effective grinding and stock removal on marble or granite. Prepares stone for polishing. Made in Korea

Resin filled for smoother polish.

6", Grit:50/60.....	\$180.00
6", Grit:100,200,400.....	\$126.00
10", Grit:50/60.....	\$235.00
10", Grit:100,200,400.....	\$181.00



## GTO Flexible Hybrid Metal Bond Pad

The GTO Series of diamond tooling is a matrix of high quality abrasive diamonds bonded with a proprietary mix of various metals and resins designed for long life, exceptional durability, high flexibility and incomparable scratch removal. The Flexible HYBRIDS are designed for wet or dry applications and the face design provides excellent channeling for dust or slurry. The consistency of performance is outstanding. The manufacturing process ensures even distribution of abrasives through the resin adding to the longevity and performance of the tooling. The GTO Series of transitional tooling is Guaranteed To Outperform any transitional diamond tooling on the market.

The GTO Series is an excellent transitional diamond generally used between aggressive metal tooling and higher grit resin bond tools. These GTO tools are unsurpassed in scratch removal usually caused by aggressive metals commonly used in the first few steps of the polishing process. The Flexible Resin is also an excellent choice where very little or no aggregate should be exposed. The flexibility of the pad follows the contour of the surface making it an ideal choice on wavy or undulated surfaces.

### Application

The GTO Series metal bond flexible HYBRID is an ideal tool on concrete and terrazzo surfaces or natural stone surfaces. The variety of sizes available provides the ideal tool for grinding/polishing floors and edges, countertops and architectural accessories.

### Specifications

- Diameters: 3", 4", 5", 7"
- Thickness: 3 MM
- Maximum Speed: 6000 RPM
- Grits: 30/50/100/200/400/800

3" .....	\$12.00
4" .....	\$16.00
5" .....	\$22.00
7" .....	\$30.00



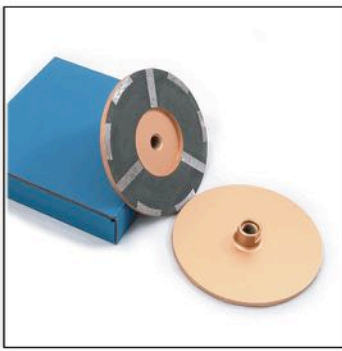

## Diamond Resin Grinding Wheel

This diamond resin grinding wheel is perfect for light weight grinding and shaping work on marble and granite without bouncing. 5/8"-11 attachment gets you easy attachment for most common hand grinders out there. Made in Korea

4", Grit:Coarse .....	\$40.80
4", Grit:Medium .....	\$40.80
4", Grit:Fine .....	\$40.80
6", Grit:Coarse .....	\$132.00
6", Grit:Medium .....	\$132.00
6", Grit:Fine .....	\$132.00

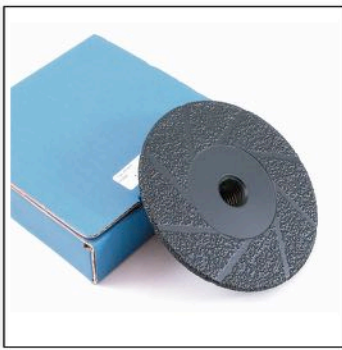

## Diamond Brazed Flat Cup Wheel

The diamonds are brazed directly to the disc to ensure excellent grinding and cutting power by the direct contact of diamond particles onto the working materials. Very cost effective! Comes with 5/8"-11 thread attachment. Made in Korea

5" .....	\$88.00
7" .....	\$135.00

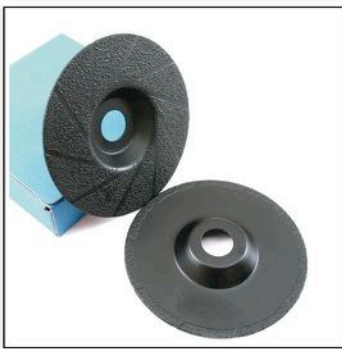

## Diamond Brazed Two-In-One Cutter

7/8" (22mm) arbor.  
Made in Korea

4" .....	\$30.00
5" .....	\$36.00



## Diamond R-Cup Wheel

The diamonds are brazed directly to the disc to ensure excellent grinding and cutting power by the direct contact of diamond particles onto the working materials. Cuvded edge makes grinding curved surfaces very easy. Comes with 5/8"-11 thread attachment. Made in Korea

4.5" .....	\$61.00
5" .....	\$69.00
7" .....	\$118.00



## Diamond Grinding Cup Wheel

These grinding wheels for stone are for dry use and made to last over a long period of use. Comes with 5/8"-11 thread attachment. Perfect for using on a Makita or any hand grinder.

5 inch .....	\$50.60
6 inch .....	\$62.40



## Double Grinding Wheel

These double grinding wheels are perfect for granite, marble, or even concrete. Double lines of segments make these wheels very aggressive. Even though they contain high quality diamond segments, we priced these aggressively to meet your needs while becoming a great value for money. Available in variety of adapter sizes. Popular 5/8"-11 thread model and also 5/8" size that comes with an arbor for 7/8" size. No matter what hand machines you are using for your grinding, these cup wheels should get the job done.

4" x 7/8"/5.8" .....	\$34.50
4" x 5/8"-11 thread .....	\$37.20
7" x 7/8"/5.8" .....	\$57.30
7" x 5/8"-11 thread .....	\$62.70



## Single Grinding Wheel

These single grinding wheels are perfect for granite, marble, or even concrete. Even though they contain high quality diamond segments, we priced these aggressively to meet your needs while becoming a great value for money. Available in variety of adapter sizes. Popular 5/8"-11 thread model and also 5/8" size that comes with an arbor for 7/8" size. No matter what hand machines you are using for your grinding, these cup wheels should get the job done.

4" x 7/8"/5.8" .....	\$19.20
4" x 5/8"-11 thread .....	\$21.90
7" x 7/8"/5.8" .....	\$38.10
7" x 5/8"-11 thread .....	\$43.50



## Twister Grinding Wheel

These grinding wheels are perfect for granite, marble, or even concrete. Even though they contain high quality diamond segments, we priced these aggressively to meet your needs while becoming a great value for money. Available in variety of adapter sizes. Popular 5/8"-11 thread model and also 5/8" size that comes with an arbor for 7/8" size. No matter what hand machines you are using for your grinding, these cup wheels should get the job done.

4" x 7/8"/5.8" .....	\$19.20
4" x 5/8"-11 thread .....	\$21.90
7" x 7/8"/5.8" .....	\$38.10
7" x 5/8"-11 thread .....	\$43.50



## Twisted Diamond Cup Wheel

The shape and placement of the segments give this cup wheel a distinct advantage when grinding granite, marble, and concrete.

4" .....	\$63.00
7" .....	\$115.00



## Alligator Grinding Cup Wheel

Available in 4" coarse for fast and efficient stock removal. Comes with 5/8"-11 thread attachment.

4" .....	\$39.00
----------	---------





## Convex Diamond Grinding Cup Wheel

This 4" cup wheel with the special curvature makes grinding easier on curved surfaces. Has Aluminum body and comes with 5/8"-11 thread attachment.

4".....\$95.00

Coarse, medium, and fine grits available

Made in Korea



## EA 4" Aluminum Turbo Grinding Cup Wheel

Comes in:

- Coarse
- Medium
- Fine

\$69.00

4" in diameter and 5/8"-11 attachment



## Maxima Turbo Diamond Grinding Cup Wheel

Use this Dia-plus Maxima Turbo Cupwheel in a light weight aluminum body to decrease workers fatigue and increase productivity.

4".....\$59.00

5".....\$73.80

6".....\$92.70

Available in 4" coarse for fast and efficient stock removal. Comes with 5/8"-11 thread attachment. Made in Korea

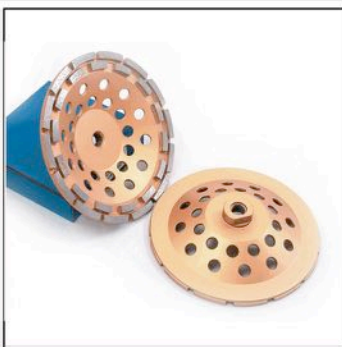

## Diamond B-Cup Grinding Wheel

These grinding wheels are great for any type of concrete construction work. They can also be used for aggressive stock removal with granite, marble, limestone, and terrazzo. Use wet or dry.

4", Segment:Single.....\$46.00

4", Segment:Double.....\$66.00

7", Segment:Single.....\$93.00

7", Segment:Double.....\$113.00

Made in Korea



## P.C.D. Diamond Cup Wheel

-Available in 4 inch and 7 inch

-Last for 900-1000 square foot.

-Specially made to CUT not grind

-Guarenteed to be the fastest removing diamond cup wheel you will ever see!

-Removes paint, urethane, epoxy, any adhesives, & leftover residue for just about anything you can think off!!

4".....call us

7".....call us

- 4" single, 4" double & 7" single, 7" double available



## Diamond Detail Bit Set

Brazed set, used for marble or any other soft natural stone.

Made in Korea

A .....	\$22.50
B .....	\$22.50
C .....	\$22.50
D .....	\$22.50
E .....	\$22.50
5 Pc Set .....	\$110.00



## Metal Floor Disc - 3"

These adhesive backed metal discs stick directly on to the driver pad. Coarse grit for grinding floors

Grit:25 .....	\$65.00
Grit:40/50 .....	\$59.00



## Metal Floor Assembly

Metal assembly screws onto driver pad of the floor machine.

Assembly .....	\$57.00
----------------	---------



# Delivery Service

Available  
Upon Request

800-342-3876





## MK Diamond PVQ Dry Grinding Discs

Four inch diameter wheels for dry marble polishing, especially for bullnose and flat edge polishing. These wheels fit 4" Makita® angle grinders. Snail Lock attachment required to use PVQ discs (not included).

Grit:40, Extra Coarse, Gray.....	\$46.00
Grit:80, Coarse, Red.....	\$46.00
Grit:220, Medium, Blue.....	\$46.00
Grit:400, Fine, Green.....	\$46.00
Grit:600, Extra Fine, Yellow.....	\$46.00
Set (1 Discs of Each Grit).....	\$46.00



## Jet Stik Flaming Tool

Originally developed to flame the edges of thin granite building panels, the JET STIK now has many uses- restoring the rough non-slip surface on granite steps worn smooth by foot traffic, removing graffiti from stone, making bird-baths, creating waterfalls, carving sculptures, and small scale quarrying of granite.

The JET STIK, with its 5000 feet per second (1500 meters per second) velocity flame, is unsurpassed in giving you the control, speed, and versatility you need when surfacing, carving, and texturing stone.

Whether you are working with granite, sandstone, bluestone, dolomitic limestone, or quartzite, the JET STIK will open up a world of new opportunities for you. It is truly the ultimate stoneworking flame tool.

Never use acetylene (C2 H2) or natural gas with the JET STIK.

It is designed to be used with propane (C3 H8) and Oxygen (O2). Other gases will cause a dangerous condition or poor results, or both.

You can use your JET STIK to:

- Put a non-skid surface on sawn granite
- Restore steps that have become smooth and slippery with use
- Make birdbaths
- Create waterfalls
- Carve sculptures
- Flame edges on thin building panels
- Thermal finish architectural panels
- Build stone landscape features and Japanese gardens
- Make custom sinks and interior design fixtures
- Channel cut for small scale quarrying
- The higher the quartz content of the stone, the faster the JET STIK works.
- Always wear eye and hearing protection.

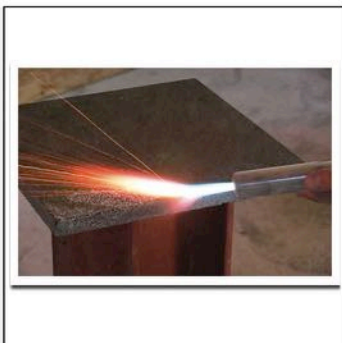

Jetstik (27" Model) Complete Kit.....	\$1,775.00
Jetstik (48" Model) Complete Kit.....	\$1,875.00
Oxygen Regulator.....	\$48.00



## Z Drum Wheel

These high quality drum/profiler wheels are perfect for granite or marble. Made from high quality diamond and metal, these come in two different attachment types.

Z-Drum: 5/8-11: Pos 1.....	\$178.40
Z-Drum: 5/8-11: Pos 2.....	\$178.40
Z-Profiler: M10: Pos 1.....	\$179.10
Z-Profiler: M10: Pos 2.....	\$179.10



## Brazed Diamond Drum Wheel

These center water feed wheels work great on any machine. Use on granite, marble or engineered stone, cleans up surface fast.  
Made in Korea

2", Grit:20/30, Coarse.....	\$129.00
2", Grit:50/60, Medium.....	\$129.00
2", Grit:100/120, Fine.....	\$129.00
3", Grit:20/30, Coarse.....	\$161.00
3", Grit:50/60, Medium.....	\$161.00
3", Grit:100/120, Fine.....	\$161.00



## Twisted Diamond Drum Wheel

5/8"-11 thread.  
Segmented and Twisted for Agressiveness.  
Made in Korea

2".....	\$85.00
3".....	\$102.00
4".....	\$136.00



## 4cm Laminated Joint-Clean-up Metal Drum Wheel

Smoothens and cleans a glue joint in preparations for your router bits. Comes with two top bearings 1/16" and 1/8" depth.

4cm.....	\$235.00
----------	----------





## Diamond Mini Drum Wheels

These resin drum wheels are perfect for working with granite or marble, especially on kitchens. Sink cutouts could be easily finished with these.

20mm #50 Grit.....	\$33.00	30mm #50 Grit.....	\$43.00
20mm #100 Grit.....	\$33.00	30mm #100 Grit.....	\$43.00
20mm #200 Grit.....	\$33.00	30mm #200 Grit.....	\$43.00
20mm #400 Grit.....	\$33.00	30mm #400 Grit.....	\$43.00
20mm #800 Grit.....	\$33.00	30mm #800 Grit.....	\$43.00
20mm #1500 Grit.....	\$33.00	30mm #1500 Grit.....	\$43.00
20mm #3000 Grit.....	\$33.00	30mm #3000 Grit.....	\$43.00
20mm Buff.....	\$40.00	30mm Buff.....	\$51.00
20mm Adapter.....	\$53.00	30mm Adapter.....	\$100.00



## Dia-Plus Resin Drum Wheel: Dry

Excellent for polishing sink cut-outs. Comes in a user friendly 5/8"-11 thread. Made in Korea

Grit:50.....	\$28.00
Grit:100.....	\$26.00
Grit:200.....	\$26.00
Grit:400.....	\$26.00
Grit:800.....	\$26.00
Grit:1500.....	\$26.00
Grit:3000.....	\$26.00
Buff - Black.....	\$30.00
Buff - White.....	\$30.00



## Dia-Plus Resin Drum Wheel: Wet

Excellent for polishing sink cut-outs. Comes in a user friendly 5/8"-11 thread. Use with water. Made in Korea

Grit:50.....	\$26.00
Grit:100.....	\$24.00
Grit:200.....	\$24.00
Grit:400.....	\$24.00
Grit:800.....	\$24.00
Grit:1500.....	\$24.00
Grit:3000.....	\$24.00
Buff - Black.....	\$28.00
Buff - White.....	\$28.00



## Diamond Resin Filled Drum Wheel

5/8"-11 thread  
2" tall

2".....	\$69.00
3".....	\$89.00
4".....	\$99.00

These center water feed wheels work great on any machine. Use on granite, marble or engineered stone. Cleans up surfaces fast.

Made in Korea



## Oscillating Polisher Drum Wheel

Designed to work with the Oscillating Head, these pads clip on and off fast and easy while staying locked in place when in use.

Specially designed holes keep the water right on the polishing surface.

Grit:50.....	\$72.00
Grit:100.....	\$72.00
Grit:200.....	\$72.00
Grit:400.....	\$72.00
Grit:800.....	\$72.00
Grit:1500.....	\$72.00
Grit:3000.....	\$72.00
Buff - Black.....	\$72.00



# TOOLS FOR DEKTON®

Alpha® now has a series of tools for the new “ultracompact” surface called Dekton® by Cosentino®. Since this material is in a whole new product category, Alpha® has studied all phases of fabrication and came up with a specialized series of tooling. The tooling has been tested and proven so there is no need to spend time and money testing at the fabrication shop. Save time and start making money with the proven Alpha® diamond tools recommended by Cosentino®.

- SILENCER III for Dekton® for bridge saws
- CNC CORE BIT for Dekton® for core drilling for corners of sink and faucet holes
- TWINCUR GEM-V for straight and beveled edge polishing using multiple-head polishing machines
- CERAMICA DRY is specifically formulated to provide the best possible finish
- CNC FINGER BIT for Dekton® for sink hole cut-outs and any exterior cutting applications
- KATANA BLADE for providing straight, precise cuts for all your needs at the jobsite



SILENCER III



CNC CORE BIT



TWINCUR GEM-V



CERAMICA DRY



CNC FINGER BIT

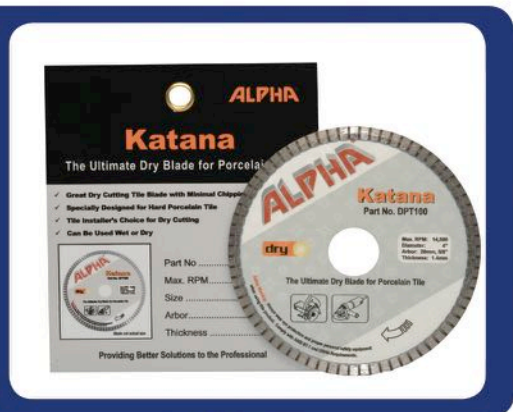

KATANA



800-648-7229 • [www.alpha-tools.com](http://www.alpha-tools.com)



**A**



A20 r5 on request    **A20 r10**    A30 r5    A30 r8    A30 r10    A30 r15

---



A40 r5 on request    A40 r8 on request    A40 r15 on request    **A40 r20**    A50 r25 on request

**B**



**B20 r20**    **B30 r25**    **B30 r30**    B40 r38 on request    BX40 r18 on request

**D**



D12 r3 on request    **D30 35° r7**    D40 25 on request    DW40 r16+9.5 on request

**E**



E20 45° p7 on request    **E30 45° p10**    E30 p0 on request    **E40 45° p22**    **E40 45° p35**

**F**



**F20 r9.8+10**    **F30 r14.7+15**    F40 r20+20 on request    FG30 r15+7.5+7.5 on request    FG40 r20+10+10 on request



FGS40 r18+16+12 on request    FO30 r11+26+9 on request    FO40 r12+34.7+14.7 on request    **FS30 r10+10**    **FS40 r10+10**

**H**



H10 r4 on request    H20 p5.15+10+20 on request    **H30 p6.3+r18.5+30**    H40 r30+40 on request    HL20 r16+p6 on request    HT20 r7.5 on request

**I**



I20 r6 on request    I30 r9 on request    L20 r10+p11.7 on request    L30 r15 on request    L2SS r25 on request    M30 r9+22 on request

**O**



O20 r8+p4+p8 on request    **O30 r12+p6+r12**    OG20 r20+6 on request    **OG30 r30+9**    OGS30 r2+7+26 on request    OGS40 r3+10+30 on request

**OS**



OS20 r5+5+5 on request    **OS30 r8+r8+r8**    Q20 r9.2+r9.2+11.6 on request    **Q30 r9.2+r9.2+11.6**    Q40 r12+12+16 on request

**T**



**T20 r3**    T20 r4 on request    **T20 r5**    **T30 r3**    T30 r5 on request    **T30 r8**

**U**



TP40 r10+10+10+5    TS30 r15+7 on request    TX30 r7 on request    TX40 r7 on request    U20 r4+13 on request    U30 r6+19.5 on request

**V**



V15 r7.5 on request    **V20 r10**    V25 r12.5 on request    **V30 r15**    V30 r18.6 on request    V34 r17 on request



V35 r7.5 on request    **V40 r20**    V50 r25 on request    **V60 r30**    **VF40 r10+10+9.8**    VF30 r7.5+7.5+7.5 on request



VF57 r8.5+8.5+20 on request    VFZ40 r12 on request    VO60 r12.7+19.05 on request    VX40 r15+p10 on request    VX41 r16.1+19.1 on request

**X**



X14 45° p10 on request    **X20 45° p17**    **X30 45° p26**    **X40 45° p34**    X50 45° p44 on request    X60 45° p54 on request

**Z**



ZX25 on request    **Z20**    **Z30**    **Z40**    Z45 on request    **Z50**



## Bevel - Amigo Stone Profiler Bit

Best Value for your money! These profiler bits fit all standard router machines. Comes with high quality bearing. Please contact us if you are looking for a grit/size/attachment that is not listed on this website.

3/4" Coarse.....\$130.00  
 3/4" Fine.....\$130.00



## Full Bull Nose - Amigo Stone Profiler Bit

NEW LOW PRICING!

Best Value for your money! These profiler bits fit all standard router machines. Comes with high quality bearing. Please contact us if you are looking for a grit/size/attachment that is not listed on this website.

3/4" Coarse.....\$95.00  
 3/4" Medium.....\$95.00  
 3/4" Fine.....\$110.00  
 1-1/4" Coarse.....\$170.00  
 1-1/2" Coarse.....\$230.00



## Ogee - Amigo Stone Profiler Bit

NEW LOW PRICE ON 3/4" OGEE BIT!

Best Value for your money! These profiler bits fit all standard router machines. Comes with high quality bearing. Please contact us if you are looking for a grit/size/attachment that is not listed on this website.

3/4" Coarse.....\$150.00  
 3/4" Fine.....\$150.00  
 1" Coarse.....\$165.00  
 1-1/4" Coarse.....\$180.00  
 1-1/4" Fine.....\$180.00



## Demi Bullnose - Amigo Stone Profiler Bit

NEW LOW PRICE!

Best Value for your money! These profiler bits fit all standard router machines. Comes with high quality bearing. Please contact us if you are looking for a grit/size/attachment that is not listed on this website.

3/4" Coarse.....\$130.00  
 3/4" Fine.....\$130.00  
 1" Coarse.....\$150.00  
 1-1/4" Coarse.....\$180.00  
 1-1/4" Fine.....\$180.00



## Breaker Wheel for Stone Profiling

This is a must have if you are doing Bullnose, Bevel, or Ogee edging on stone or concrete. Use this breaker wheel to create the shape beforehand and save the life on your other expensive profile bits. Aggressive diamond segments save your time and money!

Breaker Wheel.....\$281.35

This breaker wheel adjusts to 3/4", 1-1/4", or 1-1/2" thickness, one bit for all the sizes you need.(ADAPTER MAY BE NEEDED FOR SPECIFIC TYPES OF ROUTER)





## Ogee - Dia-Plus Profile Bit

These metal bond bits are for use on marble, granite, and all types of stone. They are aggressive, do not leave swirl marks and are priced competitively. Superior performance and durability. Comes with a guide bearing which eliminates the need for templates. Use with Master, Sector, Oma, Flex, and other standard routers. Custom shapes and sizes available upon requests. Made in Korea

3/4" Coarse .....\$206.55  
 1-1/4" Coarse .....\$279.65



## Full Bull Nose - Dia-Plus Profile Bit

These metal bond bits are for use on marble, granite, and all types of stone. They are aggressive, do not leave swirl marks and are priced competitively. Superior performance and durability. Comes with a guide bearing which eliminates the need for templates. Use with Master, Sector, Oma, Flex, and other standard routers. Custom shapes and sizes available upon requests. (ADAPTER MAY BE NEEDED FOR SPECIFIC TYPES OF ROUTER) Made in Korea

3/4" Coarse .....\$294.10  
 1-1/4" Coarse .....\$351.05  
 1-1/2" Coarse .....\$387.60



## Bevel - Dia-Plus Profile Bit

These metal bond bits are for use on marble, granite, and all types of stone. They are aggressive, do not leave swirl marks and are priced competitively. Superior performance and durability. Comes with a guide bearing which eliminates the need for templates. Use with Master, Sector, Oma, Flex, and other standard routers. Custom shapes and sizes available upon requests. (ADAPTER MAY BE NEEDED FOR CERTAIN ROUTER TYPES) Made in Korea

3/4" Coarse .....\$219.30



## Ogee Bull Nose - Dia-Plus Profile Bit

These metal bond bits are for use on marble, granite, and all types of stone. They are aggressive, do not leave swirl marks and are priced competitively. Superior performance and durability. Comes with a guide bearing which eliminates the need for templates. Use with Master, Sector, Oma, Flex, and other standard routers. Custom shapes and sizes available upon requests. (ADAPTER MAY BE NEEDED FOR SPECIFIC TYPES OF ROUTER) Made in Korea

1-1/2" Coarse .....\$313.95



## Cove Dupont - Dia-Plus Profile Bit

These metal bond bits are for use on marble, granite, and all types of stone. They are aggressive, do not leave swirl marks and are priced competitively. Superior performance and durability. Comes with a guide bearing which eliminates the need for templates. Use with Master, Sector, Oma, Flex, and other standard routers. Custom shapes and sizes available upon requests. (ADAPTER MAY BE NEEDED FOR SPECIFIC TYPES OF ROUTER) Made in Korea

1-1/4" Coarse .....\$335.75



### Triple Pencil - Dia-Plus Profile Bit

These metal bond bits are for use on marble, granite, and all types of stone. They are aggressive, do not leave swirl marks and are priced competitively. Superior performance and durability. Comes with a guide bearing which eliminates the need for templates. Use with Master, Sector, Oma, Flex, and other standard routers. Custom shapes and sizes available upon requests. (ADAPTER MAY BE NEEDED FOR SPECIFIC TYPES OF ROUTER)  
Made in Korea

1-1/4" Coarse.....\$376.55

# Largest Online Fabrication Tool Store...

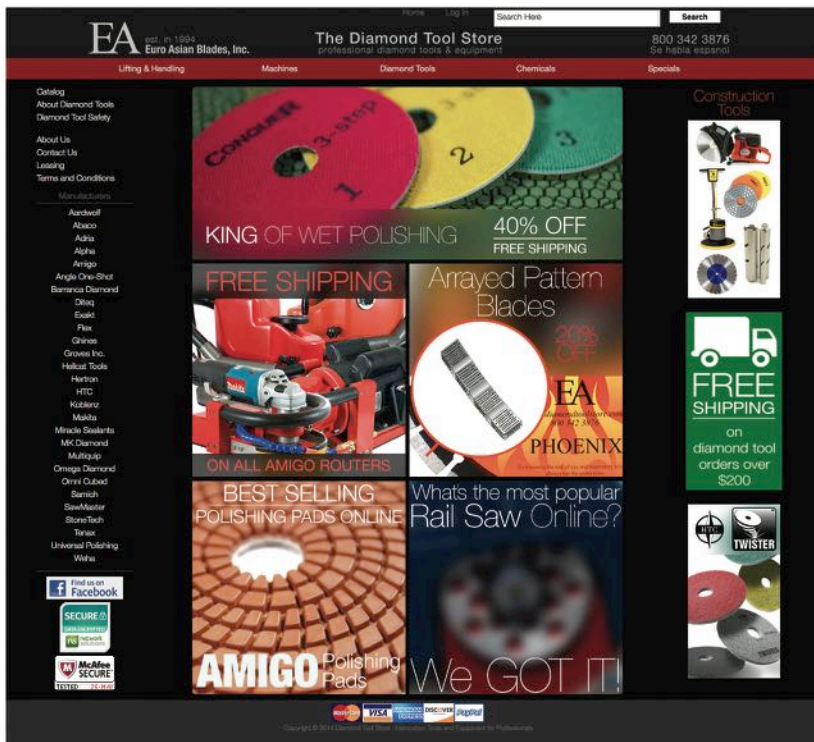

- Special Online Pricing
- Fast Processing
- Quick Delivery
- Special Package Deals

[www.DiamondToolStore.com](http://www.DiamondToolStore.com)





## Dupont (H) Premium RED Profile Bit

These metal bond bits are for use on marble, granite, and all types of stone. They are aggressive, do not leave swirl marks and are priced competitively. Superior performance and durability. Comes with a guide bearing which eliminates the need for templates. Use with Master, Sector, Oma, Flex, and other standard routers.

3/4" Coarse .....	\$196.65
1-1/4" Coarse .....	\$312.55
1-1/2" Coarse .....	\$319.39



## Cove Ogee (Q) Premium RED Profile Bit

These metal bond bits are for use on marble, granite, and all types of stone. They are aggressive, do not leave swirl marks and are priced competitively. Superior performance and durability. Comes with a guide bearing which eliminates the need for templates. Use with Master, Sector, Oma, Flex, and other standard routers.(ADAPTER MAY BE NEEDED FOR SPECIFIC TYPES OF ROUTER)

3/4" Coarse .....	\$274.46
1-1/4" Coarse .....	\$303.53



## Cove Dupont (O) Premium RED Profile Bit

These metal bond bits are for use on marble, granite, and all types of stone. They are aggressive, do not leave swirl marks and are priced competitively. Superior performance and durability. Comes with a guide bearing which eliminates the need for templates. Use with Master, Sector, Oma, Flex, and other standard routers.(ADAPTER MAY BE NEEDED FOR SPECIFIC TYPES OF ROUTER)

1-1/2" Coarse .....	\$337.25
3/4" Coarse .....	\$242.63
1-1/4" Coarse .....	\$280.16



## Demi (B) Premium RED Profile Bit

These metal bond bits are for use on marble, granite, and all types of stone. They are aggressive, do not leave swirl marks and are priced competitively. Superior performance and durability. Comes with a guide bearing which eliminates the need for templates. Use with Master, Sector, Oma, Flex, and other standard routers.(ADAPTER MAY BE NEEDED FOR SPECIFIC TYPES OF ROUTER)

1/4" Coarse .....	\$175.28
3/8" Coarse .....	\$199.50
5/8" Coarse .....	\$211.95
3/4" Coarse .....	\$236.46
1" Coarse .....	\$260.11
1-1/4" Coarse .....	\$296.78



## Bevel (E) Premium RED Profile Bit

These metal bond bits are for use on marble, granite, and all types of stone. They are aggressive, do not leave swirl marks and are priced competitively. Superior performance and durability. Comes with a guide bearing which eliminates the need for templates. Use with Master, Sector, Oma, Flex, and other standard routers.(ADAPTER MAY BE NEEDED FOR SPECIFIC TYPES OF ROUTER)

3/8" Coarse .....	\$235.60
3/4" Coarse .....	\$239.40
1-1/4" Coarse .....	\$269.80



### Full Bull Nose (V) Premium RED Profile Bit

These metal bond bits are for use on marble, granite, and all types of stone. They are aggressive, do not leave swirl marks and are priced competitively. Superior performance and durability. Comes with a guide bearing which eliminates the need for templates. Use with Master, Sector, Oma, Flex, and other standard routers.(ADAPTER MAY BE NEEDED FOR SPECIFIC TYPES OF ROUTER)

3/4" Coarse .....	\$269.80
1-1/4" Coarse .....	\$320.91
1-1/2" Coarse .....	\$354.35
2" Coarse .....	\$421.80
2-1/2" Coarse .....	\$507.30

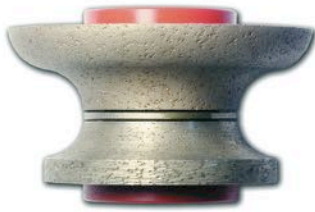

### Half Bull Nose + Ogee (F+B) Premium RED Profile Bit

These metal bond bits are for use on marble, granite, and all types of stone. They are aggressive, do not leave swirl marks and are priced competitively. Superior performance and durability. Comes with a guide bearing which eliminates the need for templates. Use with Master, Sector, Oma, Flex, and other standard routers.(ADAPTER MAY BE NEEDED FOR SPECIFIC TYPES OF ROUTER)

1-1/4" Coarse .....	\$321.01
1-1/2" Coarse .....	\$360.05



### Ogee (F) Premium RED Profile Bit

These metal bond bits are for use on marble, granite, and all types of stone. They are aggressive, do not leave swirl marks and are priced competitively. Superior performance and durability. Comes with a guide bearing which eliminates the need for templates. Use with Master, Sector, Oma, Flex, and other standard routers.(ADAPTER MAY BE NEEDED FOR SPECIFIC TYPES OF ROUTER)

5/8" Coarse .....	\$201.40
3/4" Coarse .....	\$219.45
1" Coarse .....	\$260.30
1-1/4" Coarse .....	\$277.40



### Cove (L) Premium RED Profile Bit

These metal bond bits are for use on marble, granite, and all types of stone. They are aggressive, do not leave swirl marks and are priced competitively. Superior performance and durability. Comes with a guide bearing which eliminates the need for templates. Use with Master, Sector, Oma, Flex, and other standard routers.(ADAPTER MAY BE NEEDED FOR SPECIFIC TYPES OF ROUTER)

3/8" Coarse .....	\$186.20
1/2" Coarse .....	\$213.75
5/8" Coarse .....	\$222.30



### Triple Pencil Premium RED Profile Bit

Also Called "Rounded Edge-Waterfall)

These metal bond bits are for use on marble, granite, and all types of stone. They are aggressive, do not leave swirl marks and are priced competitively. Superior performance and durability. Comes with a guide bearing which eliminates the need for templates. Use with Master, Sector, Oma, Flex, and other standard routers.(ADAPTER MAY BE NEEDED FOR SPECIFIC TYPES OF ROUTER)

3/4" Coarse .....	\$278.26
1-1/4" Coarse .....	\$304.00





## Double Demi (W) Premium RED Profile Bit

These metal bond bits are for use on marble, granite, and all types of stone. They are aggressive, do not leave swirl marks and are priced competitively. Superior performance and durability. Comes with a guide bearing which eliminates the need for templates. Use with Master, Sector, Oma, Flex, and other standard routers.

3/4" Coarse .....	\$252.89
1-1/4" Coarse .....	\$286.81



## Double Arcs (R) Premium RED Profile Bit

These metal bond bits are for use on marble, granite, and all types of stone. They are aggressive, do not leave swirl marks and are priced competitively. Superior performance and durability. Comes with a guide bearing which eliminates the need for templates. Use with Master, Sector, Oma, Flex, and other standard routers.

3/4" Coarse .....	\$253.08
1-1/4" Coarse .....	\$288.23



## Double Eased (T) Premium RED Profile Bit

These metal bond bits are for use on marble, granite, and all types of stone. They are aggressive, do not leave swirl marks and are priced competitively. Superior performance and durability. Comes with a guide bearing which eliminates the need for templates. Use with Master, Sector, Oma, Flex, and other standard routers.

1-1/4" Coarse .....	\$303.05
1-1/2" Coarse .....	\$339.15



## Double Dupont (I) Premium RED Profile Bit

These metal bond bits are for use on marble, granite, and all types of stone. They are aggressive, do not leave swirl marks and are priced competitively. Superior performance and durability. Comes with a guide bearing which eliminates the need for templates. Use with Master, Sector, Oma, Flex, and other standard routers.

3/4" Coarse .....	\$261.25
1-1/4" Coarse .....	\$287.85
1-1/2" Coarse .....	\$343.90



## Double Cove (P) Premium RED Profile Bit

These metal bond bits are for use on marble, granite, and all types of stone. They are aggressive, do not leave swirl marks and are priced competitively. Superior performance and durability. Comes with a guide bearing which eliminates the need for templates. Use with Master, Sector, Oma, Flex, and other standard routers.

3/4" Coarse .....	\$287.85
1-1/4" Coarse .....	\$342.95
1-1/2" Coarse .....	\$397.10



### Down Step Dupont (H) Premium RED Profile Bit

These metal bond bits are for use on marble, granite, and all types of stone. They are aggressive, do not leave swirl marks and are priced competitively. Superior performance and durability. Comes with a guide bearing which eliminates the need for templates. Use with Master, Sector, Oma, Flex, and other standard routers.

3/4" Coarse .....	\$197.60
1-1/4" Coarse .....	\$217.55
1-1/2" Coarse .....	\$237.50



### Cove Dupont+Half Bull Nose (OB) Premium RED Profile

These metal bond bits are for use on marble, granite, and all types of stone. They are aggressive, do not leave swirl marks and are priced competitively. Superior performance and durability. Comes with a guide bearing which eliminates the need for templates. Use with Master, Sector, Oma, Flex, and other standard routers.

1-1/2" Coarse .....	\$405.65
1-1/4" Coarse .....	\$337.25



### Vertical Shape (O) Premium RED Profile Bit

These metal bond bits are for use on marble, granite, and all types of stone. They are aggressive, do not leave swirl marks and are priced competitively. Superior performance and durability. Comes with a guide bearing which eliminates the need for templates. Use with Master, Sector, Oma, Flex, and other standard routers.

1-1/4" Coarse .....	\$304.00
---------------------	----------



# Delivery Service

Available  
Upon Request

800-342-3876





## Bevel - Premium GREEN Profile Bit

Our premium metal router bits. These metal bond bits are for use on marble, granite, and all types of stone. They are aggressive, do not leave swirl marks and are priced competitively. Superior performance and durability. Comes with a guide bearing which eliminates the need for templates. Use with Amigo, Master, Sector, Flex, and other standard routers.

3/4" Coarse .....\$216.30



## Full Bull Nose - Premium GREEN Profile Bit

These metal bond bits are for use on marble, granite, and all types of stone. They are aggressive, do not leave swirl marks and are priced competitively. Superior performance and durability. Comes with a guide bearing which eliminates the need for templates. Use with Master, Sector, Oma, Flex, and other standard routers.

3/4" Coarse .....\$247.80  
 3/4" Fine .....\$247.80  
 1-1/4" Coarse .....\$306.60  
 1-1/4" Fine .....\$306.60  
 1-1/2" Coarse .....\$338.10  
 1-1/2" Fine .....\$338.10  
 2" Coarse .....\$420.70  
 2-1/2" Coarse .....\$505.40



## Dupont - Premium GREEN Profile Bit

Our premium metal router bits. These metal bond bits are for use on marble, granite, and all types of stone. They are aggressive, do not leave swirl marks and are priced competitively. Superior performance and durability. Comes with a guide bearing which eliminates the need for templates. Use with Amigo, Master, Sector, Oma, Flex, and other standard routers.

1" Coarse .....\$222.60  
 3/4" Coarse .....\$201.60  
 1-1/4" Coarse .....\$229.60



## Demi - Premium GREEN Profile Bit

These metal bond bits are for use on marble, granite, and all types of stone. They are aggressive, do not leave swirl marks and are priced competitively. Superior performance and durability. Comes with a guide bearing which eliminates the need for templates. Use with Master, Sector, Oma, Flex, and other standard routers.

1" Coarse .....\$241.50  
 3/4" Coarse .....\$212.10  
 1-1/4" Coarse .....\$268.10



## Pencil - Premium GREEN Profile Bit

These metal bond bits are for use on marble, granite, and all types of stone. They are aggressive, do not leave swirl marks and are priced competitively. Superior performance and durability. Comes with a guide bearing which eliminates the need for templates. Use with Master, Sector, Oma, Flex, and other standard routers.

1-1/2" Coarse .....\$303.10  
 1-1/4" Coarse .....\$257.60



## Cove - Premium Green Profile Bit

Our premium metal router bits. These metal bond bits are for use on marble, granite, and all types of stone. They are aggressive, do not leave swirl marks and are priced competitively. Superior performance and durability. Comes with a guide bearing which eliminates the need for templates. Use with Amigo, Master, Sector, Oma, and other standard routers.

3/8" Coarse .....	\$193.20
3/4" Coarse .....	\$201.60



## Triple Waterfall - Premium GREEN Profile Bit

These metal bond bits are for use on marble, granite, and all types of stone. They are aggressive, do not leave swirl marks and are priced competitively. Superior performance and durability. Comes with a guide bearing which eliminates the need for templates. Use with Master, Sector, Oma, Flex, and other standard routers.

1" Coarse .....	\$298.20
3/4" Coarse .....	\$241.50
1-1/4" Coarse .....	\$298.20



## Ogee - Premium GREEN Profile Bit

Our premium metal router bits. These metal bond bits are for use on marble, granite, and all types of stone. They are aggressive, do not leave swirl marks and are priced competitively. Superior performance and durability. Comes with a guide bearing which eliminates the need for templates. Use with Amigo, Sector, Oma, and other standard routers.

3/4" Coarse .....	\$228.20
1" Coarse .....	\$269.50
1-1/4" Coarse .....	\$273.00



## Parts for Premium Green Profiling Bits

Various Parts for Premium Profiling Bits.

Stopper .....	\$53.00
Bearing .....	\$26.00
Ring 30mm .....	\$13.00
Ring 40mm .....	\$13.00
Bolt .....	\$13.00





## Bevel - Brazed Profile Bit

These high quality diamond brazed profile bits are perfect to use on marble and other soft natural stone. Comes with a smooth bearing to glide easily across the edge.

1-1/4" Coarse .....\$178.20



## Full Bull Nose - Brazed Profile Bit

These high quality diamond brazed profile bits are perfect to use on marble and other soft natural stone. Comes with a smooth bearing to glide easily across the edge.

3/4" Coarse .....\$140.40

1-1/4" Coarse .....\$163.80

1-1/2" Coarse .....\$189.90



## Ogee - Brazed Profile Bit

These high quality diamond brazed profile bits are perfect to use on marble and other soft natural stone. Comes with a smooth bearing to glide easily across the edge.

3/4" Coarse .....\$151.20

1-1/4" Coarse .....\$180.00



## EA Profiler Wheel

These profiler wheels are 6 inch in diameter and made to be used with a hand saw or a large hand cutter. High quality diamonds guarantee high quality results.

6 inch - 3/8" Bevel .....\$142.10

6 inch - 1/2" Ogee .....\$200.90

6 inch - 3/8" Ogee .....\$184.80

6 inch - 1/2" Radius .....\$154.70

6 inch - 3/8" Radius .....\$142.10

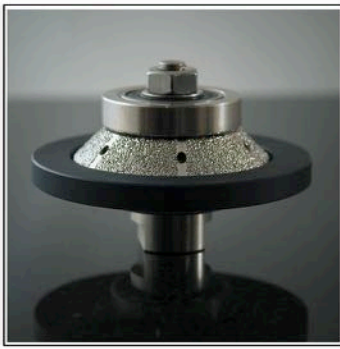

## Hand Profile Bit - Bevel (E)

These bits fits any 5/8"-11 hand machine.Extra wide, heavy duty nylon guide slides along the surface steadily and the rotary touch bearing controls the depth smoothly. Heavy duty, high quality construction ensures straight, smooth line across the edge. Use 3,500~4,500 maximum rpms with water.  
Made in Korea

- 3-16" Bevel E - Coarse .....\$120.00
- 3/8" Bevel E - Coarse .....\$142.00



## Hand Profile Bit - Radius (A)

These bits fits any 5/8"-11 hand machine.Extra wide, heavy duty nylon guide slides along the surface steadily and the rotary touch bearing controls the depth smoothly. Heavy duty, high quality construction ensures straight, smooth line across the edge. Use 3,500~4,500 maximum rpms with water.  
Made in Korea

- 3/16" Radius A - Coarse .....\$120.00
- 3/8" Radius A - Coarse .....\$149.00
- 1/2" [1cm] Radius A - Coarse .....\$154.00

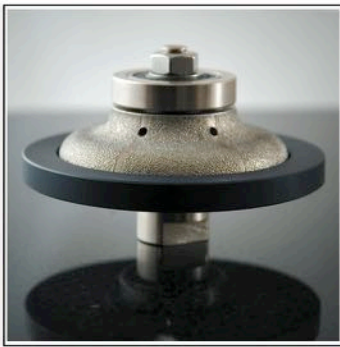

## Hand Profile Bit - Ogee (F)

These bits fits any 5/8"-11 hand machine.Extra wide, heavy duty nylon guide slides along the surface steadily and the rotary touch bearing controls the depth smoothly. Heavy duty, high quality construction ensures straight, smooth line across the edge. Use 3,500~4,500 maximum rpms with water.  
Made in Korea

- 3/4" [2cm] Ogee F20 - Coarse .....\$168.00

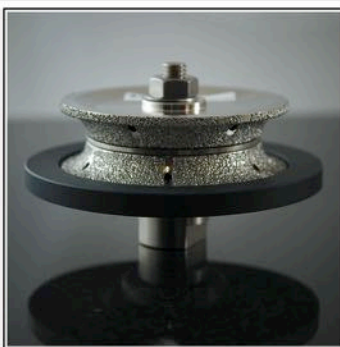

## Hand Profile Bit - Full Bull Nose (V)

These bits fits any 5/8"-11 hand machine.Extra wide, heavy duty nylon guide slides along the surface steadily and the rotary touch bearing controls the depth smoothly. Heavy duty, high quality construction ensures straight, smooth line across the edge. Use 3,500~4,500 maximum rpms with water.  
Made in Korea

- 3/4" [2cm] Full Bull Nose V20 - Coarse .....\$214.00
- 1-1/4 [3cm] Full Bull Nose V30 - Coarse .....\$225.00



## Polishing Profile Wheel

These bits are perfect for polishing stone edges with your hand machine. Comes with 5/8"-11 thread attachment that fits most hand machines out there.

- 3/4" Ogee, Grit:50 .....\$39.00
- 3/4" Ogee, Grit:100 .....\$39.00
- 3/4" Ogee, Grit:200 .....\$39.00
- 3/4" Ogee, Grit:400 .....\$39.00
- 3/4" Ogee, Grit:800 .....\$39.00
- 3/4" Ogee, Grit:1500 .....\$39.00
- 3/4" Ogee, Grit:3000 .....\$39.00





## Diamond Finger Drum Bit: 5 Segment

Due to its shape, there should be less blow out on the bottom of the stone. The diamond portion of the bit is tapered so it becomes smaller towards the tip.  
Made in Korea

25mm x 35mm - 1/2"	.....\$85.00
25mm x 35mm - 5/8"	.....\$85.00
25mm x 40mm - 1/2"	.....\$99.00
25mm x 40mm - 5/8"	.....\$99.00



## Diamond Finger Drum Bit: 6 Segment

Outer Diameter: 1 inch  
Length: 40mm (35mm is also available upon request, please contact us)  
Number of Segments: 6  
Thread: 1/2" gas (male)

1" x 40mm - 1/2"	.....\$120.00
------------------	---------------

Made in Korea



## Diamond Finger Bit Replacement Tips

For radial arm replacement.  
20 x 20 x 12mm thread.  
Made in Korea

Replacement Tips	.....\$62.00
------------------	--------------



## Diamond Finger Bits

NEW SPECIAL LOW PRICING ON 40mm and 50mm OPTIONS!

Diamond finger bits perfect for countertop fabrication and sink edging. Made for granite, marble, and other natural stone.

1" - 35mm	.....\$75.00
1" - 40mm	.....\$45.00
1" - 50mm	.....\$49.00



## Ghines CNC Profile Bits

### NO MEASUREMENT REQUIRED

GTOOLS are manufactured with careful precision and tested before shipping; every wheel has ALWAYS the same dimensions, and no measurement has to be done, neither manually nor automatically. Furthermore, thanks to their building technique, the wheels do not change their geometry during use (except for the green one). Parameters are provided with tooling.

### EASY INPUT PROCEDURE

The setting is really easy: it does not require the input of real tool dimensions, but only the nominal diameter.

### EASY CHANGE OVER CNC

GTOOLS allow the operator to replace (on the same toolholder) any wheel with a new one, resuming the job without need of any further measurement nor setting adjustment.

### ONE SET FOR EVERY MATERIAL

Thanks to the unique technologies applied in the CNC GTOOLS manufacturing process, these tools can be used on every kind of material with no more need of specific sets. You just have to pick up the right tool combination according to the material you need to work (from 4 to 7 tools).

### NO TRUING REQUIRED

CNC GTOOLS never lose their profile shape. Throughout all their life, GTOOLS ALWAYS guarantees the same final result on the slab contour.

We carry the whole line of GHINES CNC Tools. Please call 800-342-3876 for details.

### UNMATCHED FINISHING OF DIAMOND TOOLS

The combination of different diamond-application-techniques into one single set of tools delivers unmatched results...On certain materials, the finishing level given by the yellow wheel makes needless the supplementary use of polishing wheels.

### PATENTED RUBBER WHEELS

GHINES only sells patented rubber wheels, where the diamond strips are volcanized into the very rubber bond.

### NO VIBRATIONS WORKING WITH POLISHING WHEEL

SRUBBER and SINTEX tools both include a rubber support which is not simply attached to the aluminum body; during work this specially anchored rubber coating does eliminate noisy vibrations and protects from consumption CNC machine bearings.

### RUBBER AND SINTEX WHEELS ARE INTER-CHANGEABLE

Polishing Rubber and Sintex wheel can freely replace each other. Depending on the worked material, you can get perfect polish by using either RUBBER or SYNTEX, or even combining them, always achieving striking results.





### 17 inch HONEYCOMB Diamond Floor Pad

Grits 50, 100, 200, 400, 800, 1500, or 3000.....\$75.00

The 17 inch HONEYCOMB Diamond Floor Pad for marble, limestone, or concrete is the most advanced diamond pad for floors we have seen. Imagine having the ability to hone, remove scratches, and polish marble, limestone and concrete without the fuss of traditional diamond pads, sponge risers, or hook and loop drive plates.

The Honeycomb Diamond floor pads have 12 hexagon diamond resin segments infused directly into the 17" nylon pad. They take you from aggressive cutting to final polish. It is as simple as switching out 17" nylon floor pads on your standard floor machine.

The spongy nature of these pads allow the diamonds to glide over the floor without being impeded by lippage or "picture framing"

No more messy powders or messy pastes. Try the Honeycomb diamond floor pads today. Available in 50, 100, 200, 400, 800, 1500, and 3000 grits



## Delivery Service

Available  
Upon Request

800-342-3876



### Nylon Pads

White, Grey, Brown, Green, Black, Blue, Hogs Hair, and more.....\$7.50

17 inch Nylon floor pads for stripping and buffing of marble and terrazzo floors. Other diameter sizes available upon request.

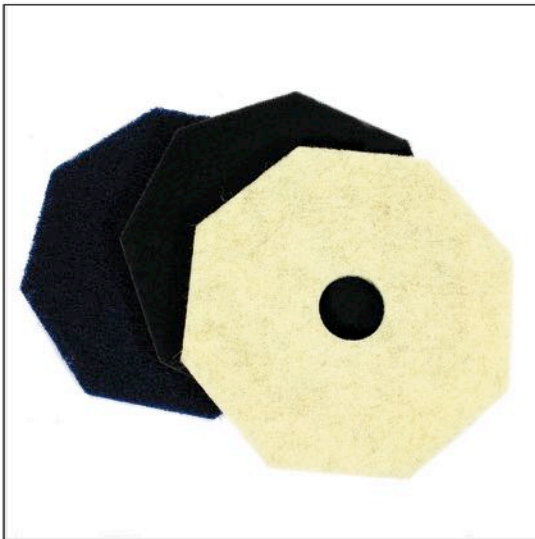

### Octagon Floor Pads

Pad Grit: Aqua Burnishing, Hair Blend Light, Tan Buffer, White Polishing, Beige Poly Thermal, Red Buffing, Blue Velvet, Buff White, Blue Cleaner, Buff Black, Brown Stripping, Green Scrubber, Black Stripping

17" 1 Pad.....\$4.50  
 17" 5 Pad Box.....\$20.00

ACS Scrubble Products division introduces a new line of patent pending, high efficiency octagon floor maintenance pads. These pads are cut so that you can utilize 8 leading edges to your advantage vs. the single radius of a round pad.

Octagon floor pads provide: deep scrub, fast strip, high shine.

The effective performance achieved and economical value is worth the try. The proof is in the performance. Octagon floor pads are available in all standard types and sizes.



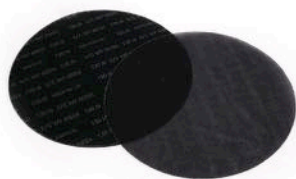

### Sand Screen

17" silicon carbide screen discs for polishing and honing of all types of marble floors and terrazzo, wet use.

Grit:60.....	\$8.44
Grit:80.....	\$6.80
Grit:100.....	\$6.80
Grit:120.....	\$6.80
Grit:150.....	\$6.80



### Metal Floor Disc - 3"

These adhesive backed metal discs stick directly on to the driver pad. Coarse grit for grinding floors

Grit:25.....	\$65.00
Grit:40/50.....	\$59.00



### Metal Floor Assembly

Metal assembly screws onto driver pad of the floor machine.

Metal Floor Assembly.....	\$57.00
---------------------------	---------

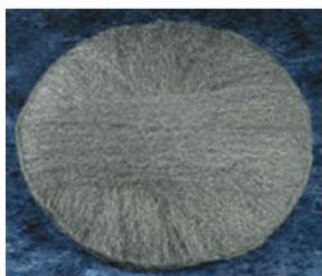

### Amifi-USA Steel Wool Floor Pads

Jumbo Floor Pads cling easily to existing disc-type rotary floor machines, so you do not need expensive adaptors. Competitively priced and larger area coverage means lower overall costs for users.

Grit:1.....	\$5.00
Grit:2.....	\$5.00



### Diamond Glass Densifier

The densifier/hardener is a water-based lithium product, some that contain Universal Polishing System's NANO glass technology. This is a concentrated formula available in 1, 5 and 55 gallon containers. While most densifiers are intended to be used as shipped, ours is concentrated so a single gallon will yield 5 gallons of densifier when used in the Diamond Glass system. Saves freight costs when concentrated and promotes GREENER projects.

Nano Densifier 82% solids (1 Gal).....	\$198.00
Nano Densifier 82% solids (5 Gal).....	\$948.00
Regular Lithium Densifier 18% Solids (1 Gal).....	\$28.00
Regular Lithium Densifier 18% Solids (5 Gal).....	\$129.00



## HTC TWISTER

2 Pads included.

5".....	\$38.00
8".....	\$40.00
10".....	\$45.00
11".....	\$49.50
12".....	\$60.00
13".....	\$61.00
14".....	\$70.00
15".....	\$72.50
16".....	\$75.00
17".....	\$78.00
18".....	\$84.00
19".....	\$86.00
20".....	\$92.00
21" (Please call to order).....	\$98.00
24" (Please call to order).....	\$120.00
27" (Please call to order).....	\$144.00
28" (Please call to order).....	\$150.00

### Black

For heavy duty cleaning of stained and dirty industrial coatings and raw concrete surfaces. Removes oil, grease, soot and truck marks. Twister™ Black is the problem solver for the industry. The Black Twister pad represents a 200 Grit.

### Red

For heavy duty cleaning of worn stone floors. Twister™ Red will effectively remove scratches and stains from the surface and leaves a clean, matt surface prepared for the subsequent Twister™ steps. The Red Twister represents 400 Grit

### White

Step 1 for the Standard or Intensive Twister™ method. Twister™ White will remove tiny scratches from the surface and leaves a silky matt, cleaned and well prepared surface for the subsequent Twister™ steps. The White Twister pad represents 800 Grit

### Yellow

Step 2 for the Standard or Intensive Twister™ method. This stage leaves a surface that is well prepared for the final step of the Twister™ method. The Yellow Twister pad represents 1500 Grit

### Green

Final step for the Standard or Intensive method and also for daily maintenance of the floor. This step will effectively maintain a high gloss on the surface when used regularly. Twister™ Green is ideal for use on all floor surfaces such as stone, vinyl and linoleum floors. For high-speed polishing of HTC Superfloor™, terrazzo and natural stone surfaces. Twister™ Green is also very effective in polishing polish-coated vinyl and linoleum floors. The Green Twister pad represents 3000 Grit.

Prices are subject to change.



## HTC Fenix

The Fenix II series is updated with a new formula and design giving the tools an increased performance.

Applications where Fenix II is suitable are grinding of screed products, concrete, natural stone and it can also be used in the HTC Superfloor™ process. The pads are easy to attach on Velcro holders under the HTC's machines. The tool series is available in sizes 5", 7", 9" and 11" and use a clear color coding which simplifies the grinding process.

- New design and optimal grinding result • New formula gives a better performance • Can grind most floor coverings
- Available in four sizes for each color
- A clear color-coding

5".....	\$44.95
7".....	\$49.95
9".....	\$64.95
11".....	\$77.95



## Pacific SeaRay 175 Floor Buffer



Pacific SeaRay 175 with 17" Plastic Plate.....\$635.00  
 Pacific SeaRay 175 with 17" Plastic Plate + Plastic Water Tank.....\$735.00

\*\*17" Plastic Plate included.

- User-friendly kick lever - no bending over to adjust handle setting
- Triple planetary gear unit with all metal gears
- Tote-A-Cap for convenient storage of pad driver or brush
- 20 Amp, 2 HP double pole switch
- 1.5 HP motor with low voltage start up down to 90 volts.
- Durable cast aluminum switch housing and metal switch levers.

The SeaRay 175 floor machine is an essential component for your floor care programs, designed to meet today's cleaning challenges. Built with durable cast aluminum housings, switch levers and bases, SeaRay's are workhorses you can depend on, year after year. The SeaRay 175 is equipped with a 17" cleaning surface and comes with a 1.5 HP motor and triple planetary gear boxes. This machine features an ergonomically-friendly kick lever for unlimited handle settings as well as the unique molded-in Tote-A-Cap feature for extending the life of pad drivers and brushes

Freight shipping charges apply. Please contact us for more details..

## Pacific SeaRay 175 HD Floor Machine



Pacific SeaRay 175 DH.....\$1,775.00

- Standard Features
- 17" brush/pad diameter
  - 7,000-9,000 sq ft per hour
  - 175 rpm
  - 1.5 hp tefc motor
  - 3 planetary gear box
  - 5" wheel diameter
  - 50' cable length
  - 14-3 cable size
  - safety lock included
  - dual switch lever

Pacific floor machines are known as the work horse of the floor machine industry with durable cast aluminum housings, switch levers and bases with triple planetary gear box that provide reliable service you can depend on year after year. The SeaRay line of floor machines come standard with a powerful 1.5 hp motor with dual capacitors, user friendly kick lever handle adjustment and convenient tote-a-cap pad driver / brush storage.

Freight shipping charges apply. Please contact us for more details.

# THE STRONGEST & SAFEST STONE HANDLING PRODUCTS AVAILABLE!

**NEW!**



Miter Up 200 advanced counter top lamination clamping system. Available in lengths of 6', 7', 8' & 10' **model: MU200-8**

**NEW!**



Heavy Duty Fabrication Table choose freestanding (F) or mobile (M) models 84" L x 25" W x 42" H **model: HDT84M / model: HDT84F**

**NEW!**



Economy Transport Cart 3,600 lb Capacity with durable powder coat finish and riveted rubber protection pads 84" L x 35" W x 60" H **model: ETC-8460**

**NEW!**



Secure A-Frame safety system holds slabs on A-frames with locking steel arms. Includes: 1 upright with locking arm 1 base with safety chains **model: SAF**



**model: TR-4482**

82" L x 44" W x 58" H

Heavy Duty Transport Rack 4,000 lb capacity

\* Shown with optional caster kit CK-4

**model: TR-4496**

96" L x 44" W x 70" H



Heavy Duty Transport Rack 10,000 lb capacity 96" L x 48" W x 88" H \* Optional caster kit CK-8000 available **model: TR-10**



Aluminum Install cart 36" Heavy duty 750 lb capacity 36" L x 24" W x 23" H **model: AIC-36**



Heavy Duty Shop Cart with 4,000 lb capacity 54" L x 38" W x 62" H **model: HDSC-48**



Fold Up A-Frame space & freight saving design patent pending. Set of two uprights and one cross bar. 24,000 lb total capacity. 60" L x 60" W x 58" H with 6" spread at top of A. **model: FAF-60**

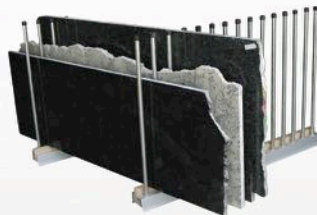

Universal Storage System 60" Aluminum rails with 30, 40" long steel posts. **model: USS-5**



Six wheeled Fabrication Carts, 2 models to choose from. FC48 48" L x 28" W x 47" H FC82 82" L x 28" W x 73" H **model: FC48 shown**



Bundle Racks 5' Long with 10 - 60" poles (Holds 4 bundles) **model: 4-W60**



Visit [www.groves.com](http://www.groves.com)

for our complete product listing!







## C Clamp 4"

Model: ACLM40D

C Clamp 4" .....\$6.50



## C Clamp 6"x3"

Model: ACLM63D

C Clamp 6"x3" .....\$8.20



## C Clamp 3"x8"

Model: ACLM38D

C Clamp 3"x8" .....\$8.20



## Abaco Carry Clamps (Two handed)

The weight of the slab exerts a sufficient clamping force for a such a simple lifting device. By eliminating the use of a forklift truck, the carry clamps help you to work more efficiently on smaller jobs. You can use multiple carry clamps to move larger slabs with ease. Full manufacturer's warranty.

Abaco Carry Clamps .....\$201.00

### Specifications:

- Grip range: 0 - 3cm
- Net weight: 3kg
- Dimensions: 285 x 120 x 240mm
- Lifting capacity per set: 200kg
- Available in set of 2



## Abaco Single-Handed Carry Clamps (Pair)

The Abaco Single Handed Carry Clamps are used to safely lift and carry stone slabs in an upright position. Just two people easily lift and position these heavy slabs using only one hand, leaving the other free. Rubber pad jaws are vulcanized to increase grip pressure and protect slabs from scratching. The handle is also rubber padded for added comfort. Full manufacturer's warranty.

Abaco Single-Handed Carry Clamps .....\$123.00

### Specifications

- Small, lightweight & sturdy, -Durable handle
- Reduce hand fatigue,
- One of the most versatile clamps

- Grip range: 0 - 2cm
- Dimensions: 215 x 120 x 200mm
- Net weight: 1.5kg
- Lifting capacity per set: 100kg
- Available in set of 2



## Aluminum Plate for SeaRay 175/175HD

Optional 17" aluminum plate for Pacific SeaRay 175/175HD Floor Polisher. Please contact us for more details.

The SeaRay 175 floor machine is an essential component for your floor care programs, designed to meet today's cleaning challenges. Built with durable cast aluminum housings, switch levers and bases, SeaRay's are workhorses you can depend on, year after year. The SeaRay 175 is equipped with a 17" cleaning surface and comes with a 1.5 HP motor and triple planetary gear boxes. This machine features an ergonomically-friendly kick lever for unlimited handle settings as well as the unique molded-in Tote-A-Cap feature for extending the life of pad drivers and brushes.

175/175HD.....\$299.00

\*\*Floor machine not included



## Plastic Plate for SeaRay 175/175HD

17" plastic driver plate for Pacific SeaRay 175/175HD Floor Polisher. Please contact us for more details.

The SeaRay 175 floor machine is an essential component for your floor care programs, designed to meet today's cleaning challenges. Built with durable cast aluminum housings, switch levers and bases, SeaRay's are workhorses you can depend on, year after year. The SeaRay 175 is equipped with a 17" cleaning surface and comes with a 1.5 HP motor and triple planetary gear boxes. This machine features an ergonomically-friendly kick lever for unlimited handle settings as well as the unique molded-in Tote-A-Cap feature for extending the life of pad drivers and brushes.

Plastic Plate.....\$90.00

\*\*Floor machine not included



## Water Tank for SeaRay 175/175HD

Optional 4 gallon water tank for Pacific SeaRay 175 Floor Polisher. Please contact us for more details.

The SeaRay 175 floor machine is an essential component for your floor care programs, designed to meet today's cleaning challenges. Built with durable cast aluminum housings, switch levers and bases, SeaRay's are workhorses you can depend on, year after year. The SeaRay 175 is equipped with a 17" cleaning surface and comes with a 1.5 HP motor and triple planetary gear boxes. This machine features an ergonomically-friendly kick lever for unlimited handle settings as well as the unique molded-in Tote-A-Cap feature for extending the life of pad drivers and brushes.

Water Tank.....\$140.00

\*\*Floor machine not included





## Suction Cup: 2 Pad

Use to easily handle fabricated pieces during installation.

Suction Cup: 2 Pad.....\$29.00

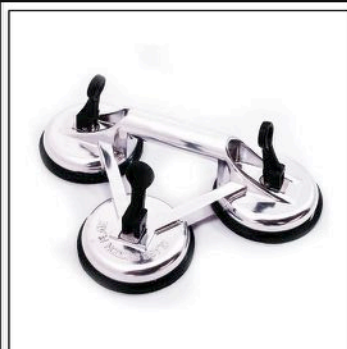

## Suction Cup: 3 Pad

Use to easily handle fabricated pieces during installation.

Suction Cup: 3 Pad.....\$40.00



## Hand Clamp 6"

Model: PHCLAM6

Hand Clamp 6".....\$13.50



## Abaco 90 M3 Degee Clamps

The Abaco 90° clamp is designed for securing and positioning slabs at a right angle. Its' jaw is adjustable to suit a variety of bench top thicknesses. Full manufacturer's warranty.

Abaco 90 M3 Degee Clamps.....\$143.00

Work capacity:  
Material Height: 180mm  
Material Thickness: 40mm

Dimensions: 213 x 136 x 305mm  
Net weight: 1.8kg

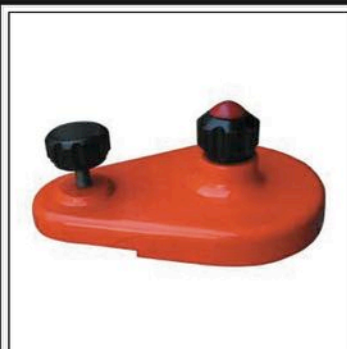

## Abaco Leveler (Pair)

- Efficient
- Accurate
- Light Weight
- Quick & Easy to Use

Abaco Leveler.....\$91.50

Abaco Levelers are designed to level the surface of your countertops.

Dimensions: 200 x 135 x 80mm  
Net weight: 1kg



## 8 Inch Suction Lifter

- 8" Diameter Vacuum Cup
- Tough light-Weight Plastic Body and barrel
- Excellent for lifting and carrying Stone Tiles, slabs and Glass
- Comes with heavy duty carrying case

8 inch Suction Lifter .....\$55.00



## Abaco Ratchet Seam Setter

The Abaco Ratchet Seam Setter provides a quick and easy solution for the accurate and safe positioning of countertops. The tool is lightweight and simple to use. No other device is this fast and convenient. Knob device allows precision vertical adjustment.

Abaco Ratchet Seam Setter .....\$240.00

Positioning /holding capacity: 60kg  
 Diameter of suction cup: 210mm  
 Length: 510mm - 584  
 Width: 220mm  
 Height: 254mm  
 Min. grip range: 510mm  
 Max. grip range: 584mm  
 Clamp weight: 6kg  
 Full manufacturer's warranty.



## Abaco Ratchet Seam Setter M2

- Specifications:
- Length : 16 3/4" - 18 3/8" (425mm - 465mm)
  - Width : 9 7/8" (250mm)
  - Height : 9 7/8" (250mm)
  - Diameter cup : 7 1/2" ( 191mm)
  - Holding capacity : 132lbs (60kg)
  - Net weight : 15lbs (7kg)

Abaco Ratchet Seam Setter M2 .....\$260.00



## Aardwolf Ratchet Seam Setter

Positions countertop horizontally & vertically. Dual-action ratcheting handle allows horizontal adjustments to tighten or loosen joint.

Aardwolf Ratchet Seam Setter .....\$305.00



## Abaco Arcturus Lifter

Designed for the thicker stone & the monument industry, larger grip range, Minimum load is 66 lbs. (30kg)

Abaco Arcturus Lifter .....\$421.25

- Length: 440mm/17.5inch
- Width: 210mm/8.25inch
- Height: 566mm/22.25inch
- Grip Range: 20mm-100mm/.75inch-4inch
- Net Weight: 80 lbs (Shipping weight)





### Abaco New Generation Lifter

The New Generation Abaco Lifter incorporates the proven "Clamping Principle". The slab will not SLIP, SNAP, CRACK or BREAK.

NGL30 (7.6"x7.6"x21.0", Grip:0.4"-1.1", Clamp: 50.2lb, W.L.L.:2640lb)	.....\$459.00
NGL40 (7.6"x8.0"x21.0", Grip:0.4"-1.5", Clamp: 50.6lb, W.L.L.:2640lb)	.....\$459.00
NGL50 (7.6"x8.4"x21.0", Grip:0.4"-1.9", Clamp: 50.6lb, W.L.L.:2640lb)	.....\$495.00
NGL60 (8.5"x10.0"x21.1", Grip:0.4"-2.3", Clamp: 77.0lb, W.L.L.:2640lb)	.....\$535.00
NGL75 (8.5"x10.6"x21.1", Grip:0.7"-2.9", Clamp: 79.2lb, W.L.L.:2640lb)	.....\$535.00



### Abaco Arcturus Lifter

Designed for the thicker stone & the monument industry, larger grip range, Minimum load is 66 lbs. (30kg)

Length: 440mm/17.5inch  
 Width: 210mm/8.25inch  
 Height: 566mm/22.25inch  
 Grip Range: 20mm-100mm/75inch-4inch  
 Net Weight: 80 lbs (Shipping weight)

Abaco Arcturus Lifter .....\$421.25



### Abaco Little Giant Slab Lifter

The compact design of the Abaco Little Giant Lifter will help solve the problem where head room is an issue. Application - For lifting 15 to 75mm thick material. (SWL 1200kg)

These clamps with their rubber-lined jaws have been developed to handle material in slab or sheet form, stacked in racks, without damaging the material's surface. They have a number of advantages over the common clamping devices.

ALG50 (8.4"x6.3"x14.2", Grip:0.5"-1.9", Clamp: 48.5lb, W.L.L.:2640lb)	.....\$481.00
ALG60 (8.4"x8.0"x16.0", Grip:0.7"-2.3", Clamp: 60.5lb, W.L.L.:2640lb)	.....\$535.00
ALG75 (8.4"x8.4"x16.0", Grip:1.1"-2.9", Clamp: 60.5lb, W.L.L.:2640lb)	.....\$535.00



### Abaco Scissor Clamp

Specifications

Grip range: 3/8-4 inches  
 Work load: 1650 pounds  
 Light weight clamp: 46 pounds  
 Dimensions: 21 1/4 X 7 X 15 3/8  
 Auto lock for easy release.  
 Long lasting fully vulcanized rubber pads.  
 All natural rubber provide a better grip.  
 Protected rubber across jaws (prevents chipping).  
 Swivel eye. Bow shackle included. Replacement pads available. Full manufacturer's warranty.

Abaco Scissor Clamp .....\$210.25



### Aardwolf Scissor Lifter 350

Rubber contact pads protect load. Clamps are gravity operated with the jaw clamping force being a factor of the load weight.

Aardwolf Scissor Lifter 350 .....\$495.00

Clamp weight: 101 lbs  
 Grip range: 6" - 14"  
 Work load: 2,200 lbs  
 Dimensions: 21 11/16" x 22" x 8"  
 Auto locks & unlocks  
 Vulcanized rubber pads

## Weha T1500/750 3300lb Capacity Air Power Tilt



The Weha T1500 Pneumatic Air Vacuum Lifter is a very diverse Vacuum lifter.  
 Powered by an air venturi system.  
 Requires a minimum of 58 PSI at 4 CFM or 4 bar  
 5 fully adjustable vacuum cups.  
 The cups have multiple locking stops along the bar for smaller or larger pieces  
 Each cup can swivel to 90 degrees.  
 Power vertical/horizontal tilt from 0-90 degrees  
 Large pressure gauge directly in front of operator to continually monitor air pressure at all times.  
 Galvanized Steel construction.

\$6588.00

Load Capacity Horizontal: 1500 KG (approx 3300 lbs)  
 Load Capacity Vertical: 750KG (approx 1600 lbs)  
 Height with power tilt: 39"  
 5 Suction Pads Each: 21.3" X 6"  
 Length of Crossrail: 59"  
 Length of Operating Arm: 23"  
 Weight: 203 lbs)

## Weha T900 Vacuum Lifter 2000lb capacity



The Weha T900 Vacuum lifter is an easy, fast lifting and setting Vacuum Lifter for moving stone slabs. Perfect for fitting and removing from CNC machines, saws or indoor transport.  
 Designed to lift all natural and engineered stone slabs and cut countertop pieces.  
 Works with continual air via a venturi system for constant vacuum.  
 With this Power Tilt version, the slabs or countertops will go from horizontal to vertical (vice versa) simply by pushing/pulling the lever.  
 Galvanized steel framework

\$4790.00

Minimum 4cfm@60PSI required  
 Load Capacity Horizontal: 900 KG (approx 2000 lbs)  
 Load Capacity Vertical: 450KG (approx 1000 lbs)  
 Height with Power Tilt: 39.4"  
 3 Suction Pads: Each: 21" X 6"  
 Length of Crossrail: 59"  
 Length of Operating Arm: 22.8"

## Weha T1600/800 8 SV Pneumatic Power Tilt Vacuum Lifter



The Weha T1200/800 Pneumatic Air Vacuum Lifter is a very diverse Vacuum lifter.  
 Powered by an air venturi system.  
 Requires a minimum of 58 PSI at 4 CFM or 4 bar  
 4 fully adjustable vacuum cups.  
 Large pressure gauge directly in front of operator to continually monitor air pressure at all times.  
 Galvanized Steel construction.  
 Once the foam rings for the rough surfaces are worn, simply pull them out, turn them over and insert them for double use. Once those are worn out, all you have to replace are the inexpensive foam rings-not the entire cup.

\$9443.78

- 8 - 12" Vacuum-Suction Pads (individually shut-off)
- Quick adjustment of suction pads in length and cross direction
- Operation via an external Vacuum-Unit
- Galvanized frame construction
- Safety-vacuum tank of aluminum (rust free)

## Weha EP300 Unipad Handpump



The EP 300 comes with both Handpump and Air connection. This means that it will build and maintain pressure without air or external power.  
 It also comes with an air connection. This can be connected to an air compressor that operates via a venturi system.

\$2339.00

Comes with a multi-filter and water trap  
 Prevents the penetration of dust and moisture.  
 Protects the pneumatic structural parts against premature wear

- Comes with 6 month warranty
- Load Capacity Horizontal: 661 lbs
- Load Capacity Vertical: 331 lbs
- Suction Plate: 21.3" x 6"

## Weha EP800 Unipad Pneumatic Vacuum Lifter



EP800 Unipad Handpump and Air Connection  
 Designed to be attached to a compressor with the Air Connection.  
 But also can be used free standing by means of the Handpump. Simply pump the hand pump a few times to create vacuum and strong suction.  
 The onboard tank reservoir stores extra air for long suction times.  
 Powered by an air venturi system.

\$2369.00

- ☒ Load Capacity Horizontal: 1764 lbs
- ☒ Load Capacity Vertical: 882 lbs
- ☒ Suction Plate: 28" x 12"
- ☒ Weight: 73 lbs





## Wood's Powr-Grip 8 Cup Vacuum Lifter

Standard Vacuum Pad Spread:  
21" x 77" [532 x 1956 mm]  
Number / Size of Vacuum Pads:  
8 / 10" [254 mm] dia. lipped vacuum pads  
Load Capacity:  
1200 lbs [545 kg]  
Weight of Vacuum Lifter:  
104 lbs [48 kg] without power system

Wood's Powr-Grip 8 Cup Vacuum Lifter.....\$3,340.00

Available Power Systems:  
DC power system (MT8HV11DC).....\$3810  
Air (venturi) power system (MT8HV11AIR).....\$3165  
AC power system (MT8HV11AC).....\$3345  
120 volts AC, 50/60 hertz, 6 amps  
(240 volts AC, 50/60 hertz, 3 amps also available)



## Wood's Powr-Grip Variable Position Vacuum Lifter

Closed Cell Foam Pad Rings are available for any of Powr-Grip's below-the-hook lifters that are equipped with HV11 vacuum pads. This option is indispensable for lifting stone slabs or other materials with surface texture: The rougher the surface, the more difficulty vacuum pads have sealing against it, thus allowing air to leak under the pads. Smooth surfaces, such as polished stone, generally seal well with standard vacuum pads. However, saw-cut and honed surfaces have some texture that can make sealing more difficult. For rougher surfaces, such as flame-cut stone, foam rings are essential to attain a good seal. The flexible foam rubber in these rings helps vacuum pads conform to rough surfaces and reduces the vacuum flow needed to overcome leakage.

Wood's Powr-Grip Vacuum Lifter.....\$3,800.00

Number / Size of Vacuum Pads:  
MRT49DC - 4 / 9" [229 mm] diameter vacuum pads  
MRT411LDC - 4 / 11" [280 mm] dia. lipped vacuum pads  
MRT4HV11DC - 4 / 10" [254 mm] dia. lipped vacuum pads

Load Capacity:  
MRT49DC - 500 lbs [225 kg]  
MRT411LDC - 700 lbs [320 kg]  
MRT4HV11DC - 600 lbs [270 kg]



## Aardwolf 2 Cup Vacuum Lifter

Designed to lift smooth or rough stone. Features rugged construction with the added ability to lift and then tilt the stone. Powered by either air or electricity.  
• Pneumatic vertical-horizontal tilting from 0 to 90° by pneumatic pistons.  
• Either electrically operated vacuum pump, 220 V single-phase or 12/24 V direct current or compressed air operated vacuum pump at a pressure of 6-7 Bars.  
• Stainless steel vacuum tank ensuring safe pickup in the event of a sudden power break to the vacuum pump.  
• Acoustic and visual alarm system. Independently powered by a rechargeable battery.  
• Pickup handle featuring pickup and material detachment controls. Suction pads can be rotated 90° to change configuration

Aardwolf 2 Cup Vacuum Lifter.....\$2,995.00

MODEL AVL P 2  
Pad size:19.65" x 11.80"  
Load capacity: 1,102 LBS.

With Stand: +\$200.00



## Aardwolf 4 Cup Vacuum Lifter

Designed to lift smooth or rough stone. Features rugged construction with the added ability to lift and then tilt the stone. Powered by either air or electricity.  
• Pneumatic vertical-horizontal tilting from 0 to 90° by pneumatic pistons.  
• Either electrically operated vacuum pump, 220 V single-phase or 12/24 V direct current or compressed air operated vacuum pump at a pressure of 6-7 Bars.  
• Stainless steel vacuum tank ensuring safe pickup in the event of a sudden power break to the vacuum pump.  
• Acoustic and visual alarm system. Independently powered by a rechargeable battery.  
• Pickup handle featuring pickup and material detachment controls

Aardwolf 4 Cup Vacuum Lifter .....\$3,495.00

MODEL AVL P 4  
Pad size:19.65" x 11.80"  
Load capacity: 2,204 LBS.



## Anver Powered Vacuum Lifter

Compressed Air Powered Vacuum Lifter and Powered Tilter with Three In-Line Vacuum Pads  
Max Sheet Size: Lifting and Tilting Stone 10 ft x 6 ft (3.1 m x 1.8 m) up to 1500 lbs (680 kg)

Anver Powered Vacuum Lifter .....\$3,500.00

### Wood's Vacuum Loss Warning Buzzer

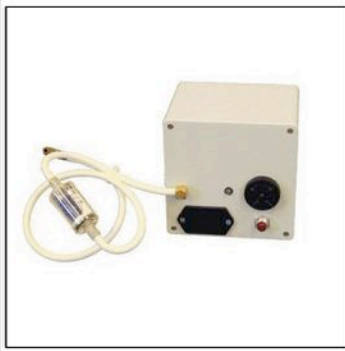

Powered independently by a long-lasting 9-volt battery, the Vacuum Loss Warning Buzzer is available for all of Powr-Grip's below-the-hook vacuum lifters. This optional device automatically monitors the lifter's vacuum and sounds an alarm if the lifter does not reach or maintain a level that is sufficient for lifting. Unlike buzzers that sound whenever the lifter is not attached to a load, the Vacuum Loss Warning Buzzer uses advanced logic circuitry to warn the operator only when insufficient vacuum poses a hazard.

Wood's Vacuum Loss Warning Buzzer .....\$485.00

Alarm volume (variable): maximum of 103 dBa at 2' [60 cm]  
 Enclosure dimensions: 4-3/4" [120 mm] width x 4-3/4" [120 mm] height x 3-3/4" [95 mm] depth  
 Power source: 9-volt lithium battery  
 Weight: 1.1 lbs [0.5 kg]  
 Supplied with mounting bracket (specify lifter type when ordering)

### Abaco Swing Arm Forklift Boom



The Abaco Swing-Arm Forklift Boom is ideal for hard to reach slabs. It has a large swing area and a long extendable arm. Ideal for small factories where space is an issue. Teamed with the Abaco Lifter make this the best way to unload containers.

Abaco Swing Arm Forklift Boom .....\$651.00

Length: 60-94 inches  
 Width: 35.4 inches  
 Weight: 275

Fully extends to 98 1/2" (2500mm)  
 Arm swings with five locking points  
 Locked angles make it easy to reach loads  
 Teamed up with an Abaco lifter is the best way to unload containers  
 Slots for forks measure 6 1/2" x 2 1/2" (165mm x 63mm)

### Abaco Forklift Boom



Designed for use on 2 & 2.5 ton forklift trucks. With its telescopic boom it offers versatility with maximum visibility for the driver. Fully extended it reaches up to 94.5" (2400mm).

Abaco Forklift Boom .....\$530.00

Length Range:60-94", Width: 22", Height: 14.4"  
 Maximum Load: 1100 lbs,  
 Net Weight: 225 lbs,  
 W.L.L.: 3300 lbs

### Abaco Spreader Bar



Specifically designed for the stone industry. This Spreader Bar is an invaluable piece of equipment where stone is required to be rolled over. Slings are suspended on crowned aluminum rollers. Width 440mm to 1440mm.

Abaco Spreader Bar .....\$367.00

Length: 106-1/4 inch  
 Width : 5-7/8 inch  
 Height: 10-1/4 inch  
 Weight: 101 lbs

### Groves Fork Lift Boom



Boom is designed for use on 2 & 2.5 ton fork lift trucks. The boom's telescopic boom offers versatility with maximum operator visibility. When fully extended the boom has a reach of 98" Boom extension design prevents the complete pullout of the boom extension. Capacities: Fully retracted 3,306 lbs. - Fully extended 1,102 lbs  
 Weight: 235lbs

Groves Fork Lift Boom .....\$635.00





## Groves Slab Dolly

- Maneuvers easily indoors and out.
- 3" wide neoprene rubber is easy to clean, prevents slippage and lasts for years.
- Pneumatic tires reduce breakage caused by vibration.
- 12" width measured from outside of wheels adds stability.
- 1,000 lb. capacity using 10" tires and 4" casters.
- 500 lb. capacity using 8" tires and 3" casters.

SD-36 (Length:36", Trim:10", Caster:4", Channel:6.5", Weight:25).....\$166  
 SD-48 (Length:48", Trim:10", Caster:4", Channel:6.5", Weight:30).....\$195  
 SD-72 (Length:72", Trim:10", Caster:4", Channel:6.5", Weight:40).....\$230



## Abaco 3 Wheel Slab Dolly

The 3 Wheel Glass Dolly is designed to facilitate the handling and transporting of glass sheets on the work site. The rubber vulcanized channel protects glass sheets from chipping and scratching. It comes with pressurized wheels and a heavy duty locking brake swivel caster to provide additional stability and maneuverability in confined spaces.

Abaco 3 Wheel Slab Dolly.....call for price

Made in 2 sizes to meet your needs.



## Aardwolf Load Master Slab Trolley

20" SLAB TROLLEY with 13" PNEUMATIC RUBBER WHEELS

Aardwolf Load Master Slab Trolley.....\$215.00

- 2 Pneumatic rubber tires: 13", 1 swivel caster 5-5/10"
- Bottom, sides & top edges of channel are rubber padded.
- Loading capacity: 880 lbs
- Weight : 33 lbs
- Support plate: 1' - 7-7/10" wide channel



## Abaco Self-Locking Dolly M2

Abaco Self-Locking Dolly M2.....\$341.00

Designed, with self-locking jaws, for maneuvering glass and stone slabs around the shop, warehouses or on work sites. The rubberized jaw and base protects slabs against chipping and scratching while transporting. The self-locking jaws clamping strength is proportional to the weight of the slab, hence the heavier the slab the larger the clamping force.

The Dolly has 14" x 4" (350mm x 100mm) diameter pressurized wheels and a 5" (125mm) heavy duty swivel caster that increases stability and flexibility in narrow and rough surfaces

Grip range : 3/8" - 4" (10 - 100mm)  
 Loading capacity : 880 lbs (400kgs)  
 Seat length : 19 1/4" (490mm)  
 Net Weight : 59 lbs (27kgs)  
 Length : 19 1/4" (490mm)  
 Width : 20 1/2" (520mm)  
 Height : 18 1/2" (470mm)



## Abaco Self-Locking Dolly M3

Abaco Self-Locking Dolly M3.....\$320.00

Heavy trolley with two pneumatic tires wheels 13 3/4" x 4" (350mm x 100mm) in diameter or optional pressurized rubber types and self-locking jaws. It is an all terrain trolley. The rubber is vulcanized to the bottom, sides and top sides of trolleys to avoid chipping edges of finished work piece.

M4 model comes with 2 solid rubber wheels.

Grip range : 3/8" - 4" (10 - 100mm)  
 Loading capacity : 880 lbs (400kgs)  
 Seat length : 19 1/4" (490mm)  
 Net Weight : 59 lbs (27kgs)  
 Length : 19 1/4" (490mm)  
 Width : 20 1/2" (520mm)  
 Height : 18 1/2" (470mm)



## Grove AIC-36 Aluminum Install Cart

Uses (4) 8" all terrain pneumatic casters, 2 swivels, and 2 rigid with brake that provides a dampening effect, when going over rough terrain.

Heavy duty 750lb. capacity.

High ground-clearance for stairs thresholds, and curbs.

Wheels can rest on the stairs treads.

The AIC uses four easy to use clamps secure material to cart, While the AIC uses 2.

Grove AIC-36 Aluminum Install Cart.....\$490.00

Length 36"  
Width 20"  
Height 22..5



## Grove AIC-68 Aluminum Install Cart

Uses (4) 8" all terrain pneumatic casters, 2 swivels, and 2 rigid with brake that provides a dampening effect, when going over rough terrain.

Heavy duty 750lb. capacity.

High ground-clearance for stairs thresholds, and curbs.

Wheels can rest on the stairs treads.

The AIC uses four easy to use clamps secure material to cart, While the AIC uses 2.

Grove AIC-68 Aluminum Install Cart.....\$545.00

Length 68"  
Width 20"  
Height 27"  
Weight 53"



## Groves Single-Sided Shopping Cart

Holds Fabricated parts.

Easy clean-up with hose.

Removable top A-frame for economical shipping.

7" Ledge depth

10" diameter pneumatic tires.

5" diameter swivel locking casters.

2,000lbs capacity.

Groves Single-Sided Shopping Cart.....\$325.00



## Abaco V-Cart

The Abaco V-Cart is a utility cart designed for storing and transporting slabs easily. Its compact structure is designed with 4 heavy duty polyurethane swivel casters for easy maneuvering in narrow areas.

The V-Cart enables positioning of slabs in any direction for any purpose. The poles can be repositioned to meet your needs. The poles and base are rubber lined to protect your material from scratching and chipping. Its durable construction adds stability when handling heavy slabs.

Abaco V-Cart.....\$571.00

Dimensions: 37 3/8 x 35 3/8 x 47 1/4"  
W.L.L.: 2200 lbs (1000kg)  
Net Weight: 160 lbs (73kg)



## Abaco Fabrication Stand (Set of 2)

The Abaco Fabrication Stand is designed to support slabs for polishing, sharpening, cutting and many other purposes.

The height is adjustable from 31 1/2 - 39 3/8" (800 - 1000mm), and it accommodates all slab lengths and shapes by adding more stands. The top is covered in rubber which protects slabs from being damaged. It folds easily for carrying from job to job.

Abaco Fabrication Stand (Set of 2).....\$208.00

Net Weight: 28.6 lbs (13kg)  
Loading Capacity: 660 lbs (300kg)  
Dimensions: 26 x 18 1/4 x 31 1/2 - 39 3/8"  
(660 x 465 x 800 - 1000mm)





## Groves Fabrication Stand

Fabrication stand can be used in the shop or on the job. Adjustable to any height from 36" to 42". Stackable for transporting or storage. Rubber mounted on top prevents sliding and scratches. Set up your entire job to ensure correct fit to templates and continuity of polish.

Groves Fabrication Stand .....\$88.00



## Groves Foldable A-Frame

Base arms fold up for ease of shipping and storage when frames are not in use.

Groves Foldable A-Frame .....\$169.00

12,000 pound total capacity, 6,000 per side. 60" long x 60" wide x 58" high with 6" spread on top of A. Ships knocked down for lower freight cost.

Hot dip galvanized finish.



## Abaco Standard A-Frame

Comes as a set of two. Designed for the storage of slabs. It is constructed of 2" square steel tubing and a 4" channel base, therefore it is a sturdy structure when compared to other A-Frames on the market. Includes angled timber base blocks to protect material.

Abaco Standard A-Frame .....\$268.00

Loading Capacity: 3000 lbs (1363kg) Per Side.  
 Length: 60" (1524mm)  
 Width: 4" (100mm)  
 Height: 60" (1524mm)  
 Net Weight: 66 lbs (30kg)



## Groves Truck Mounted A-Frame

24,000 lb. total capacity. Holds up to 12,000 lbs. per side. Six mounting plates used for bolting to truck or trailer. Bottom U-channel is 4" wide with 2" side ledges and is designed to hold wood 4x4's to support the load. Customer furnishes the wood. Rubber-lined uprights help prevent scratches. Removable X and cross braces bolt together for ease of transporting, and reduces shipping costs. Galvanized finish for long-lasting durability.

Groves Truck Mounted A-Frame .....\$1,315.00



## Grove Econo A-Frame

Heavy duty, 146lb. Steel A-Frame Rack.

Grove Econo A-Frame .....\$235.00

Holds up to 12,000 lbs per side. 60" long x 60" wide x 58" high with 6" spread on top of A. Ships knock down for lower freight cost. Hot dip galvanized finish. Bottom U-channel is 4" wide with 1" side ledges and is designed to hold wood 2 x 4's to support the load. Customer furnished the wood



## Abaco Universal A-Frame M2

This Universal A-Frame M2 is designed for safe and easy access to all of your slabs. This heavy duty A-Frame can handle more than 24,000lbs per side (W.L.L. = 48,000lbs total) and comes with 4 safety securing bars where slabs can be leaned against for frequent retrieval of slab(s) safely and with minimal labor. This must have A-Frame not only saves workers' time, but also prevents unnecessary and excessive moving of slabs by keeping them organized and secured in one area.

Abaco Universal A-Frame M2.....\$865.25

Between Posts, Max Capacity: 1100 lbs (500kg)  
 Loading Capacity Per Side: 24,000 lbs (11,000kg)  
 Length: 106 1/4" (2700mm)  
 Width: 68" (1725mm)  
 Height: 63" (1600mm)  
 Net Weight: 380lbs (173kg)  
 Length of Safety Bar: 51 1/8" (1300mm)



## The Powr-Grip® SD1 Stone Dolly

The Powr-Grip® Stone Dolly eases the burden of moving stone up and down stairs or anywhere within the shop and on the job site. Wide, stable wheel base. Can transport loads in either horizontal or vertical orientation. Vertical transport allows easier maneuverability in hallways and elevators. Large pneumatic tires make it easier to roll over uneven surfaces. Accommodates stone and other materials in widths up to 2" [5 cm]

The Powr-Grip® SD1 Stone Dolly.....\$1,590.00

Load Capacity:  
 700 lbs [320 kg]  
 Unit Weight:  
 83 lbs [38 kg]  
 Dimensions:  
 Width: 26" [664 mm]  
 Length: 48-1/2" [1230 mm] to 67" [1705 mm]  
 Height: 12-3/4" [323 mm] to 39-3/4" [1008 mm]



## Aardwolf Lite Stone Panel Carriers with Cable

- Easy to use
- Locks on panel automatically
- Lifting cap. per set : 330lbs
- Designed for manual lifting only
- Rubber lined spring loaded heads
- Non-marking rubber pads
- Aluminum body & molded rubber hand grips
- Grip range 0" to 2 1/2"

Aardwolf Lite Stone Panel Carriers.....\$69.00



## Aardwolf Swivel Shackle and Lifting Lug

- Designed by Aardwolf specifically for its range of Aardwolf lifting clamps. Forged from high grade aluminium.
- Combination lifting lug, chain and Aardwolf swivel shackle.
- Weight - 3 lbs
- Allows flex between the boom and load.
- Prevent slab breakage when traversing rough terrain.

Aardwolf Swivel Shackle and Lifting Lug.....\$87.00



## Groves Display Racks

3,000 lb. capacity, 350 lb. maximum per ledge. Displays eight full size tops up to 3 cm thick. Black enamel finish. Use 1/2" holes located on the bottom for securing to the floor.

Groves Display Racks.....\$600.00

Length: 72", Width: 50", Height: 78"  
 Ledge: 26.5", Weight lbs.: 230





## Groves Fabrication Stand

Designed to support sink cutouts during fabrication.  
12" x 12" base to support material.  
Ships UPS for freight savings.

Adjustable Height: 23.5" to 40"  
Weight: 8lbs

Groves Fabrication Stand.....\$110.00



## Groves Sample Display Rack

Safely display 26 - 10" x 10" product samples.  
Durable black powder coat finish. Easy assembly and ships knocked down for Freight savings.  
21" wide, 74" High and weighs 53lbs.

Groves Sample Display Rack.....\$220.00



## Groves Heavy Duty Shop Cart

- Rugged 4000 lb. capacity.
- Rubber is mounted on base and upright supports to help protect material.
- Six ratchet straps are included to secure load.
- The HDSC-48 uses 5" casters, two rigid and two swivel with brake rated at 1000 lbs. each.
- The HDSC-8448 and HDSC-8472 use 8" casters, two rigid and two swivel with brake rated at 1000 lbs. each.

HDSC48 (Length:54", Width:38", LoadHeight:48", Height:59", Weight:215).....\$605  
HDSC8448 (Length:84", Width:40", LoadHeight:48", Height:63", Weight:360).....\$810  
HDSC8472 (Length:84", Width:40", LoadHeight:72", Height:87", Weight:460).....\$985



## Groves Six Wheeled Fabrication Cart

Raised material supports for ease of loading, and will keep the finished material high off the ground.  
Holds up to 3,200 pounds.  
Heavy duty rubber is mounted on the base and the uprights to help prevent slipping and damage to the material.  
Forklift-able to help with the loading and unloading of delivery equipment, and moving raw material to fabrication area.

FC48 - 48" Long x 25" Wide x 53" High with a 42" Load Height.....\$470  
FC82 - 82" Long x 25" Wide x 73" High with a 60" Load Height.....\$655



## Groves Heavy Duty Transport Rack-10,000lbs

10,000lbs.capacity designed to hold all size slabs. Optional caster package consists of 8" diameter roller bearing wheels rated at 2000lbs each. Two swivels coasters with brakes on one end and two rigid on the other lift with overhead crane using four base mounted lifting rings. Four hold down ratchet straps secure load. CAPACITY OF THE TR-10 IS REDUCED TO 8,000 lbs WITH THE USE OF THE CK-8,000 CASTER KIT.

Groves Heavy Duty Transport Rack.....\$2,199.00



## Groves Stacking Racks

Designed to be Stacked Three High with a Stationary Bottom. Wheels can only be used when not stacked. Maximum capacity is 3,000 lbs. total. One rack can hold 3,000 lbs. If stacked three high, each rack can only hold 1,000 lbs.

Groves Stacking Racks.....\$480.00

Length: 37.5"  
Width: 29.5"  
Height: 42"  
Ledge: 20.5"  
Weight: 200lbs

SRCK-5 Caster Kit: Weight: 35lbs.....\$55

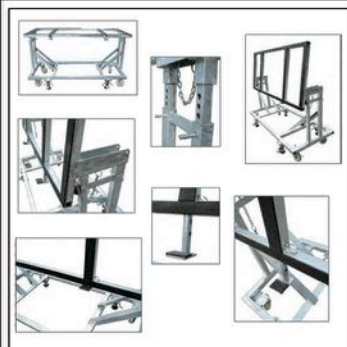

## Groves Tilt Table Cart

Dual purpose work bench and transport cart. Adjustable length material stops. Adjustable height 36" to 42"  
Four swivel 5" diameter casters, 1000 lb. capacity each. Four heavy duty foot operated locks prevent movement while fabricating. Hot dip galvanized finish. Ships knocked down for freight savings.

Groves Tilt Table Cart.....\$875.00

Part No.....	Trim Size....	Width....	Adj.Height....	Weight-lbs
TT3272.....	72"	32"	36"- 42"	250



## Groves Heavy Duty Transport Rack-10,000lbs

10,000lbs.capacity designed to hold all size slabs. Optional caster package consists of 8" diameter roller bearing wheels rated at 2000lbs each. Two swivels coasters with brakes on one end and two rigid on the other. Lift with overhead crane using four base mounted lifting rings. Four hold down ratchet straps secure load. CAPACITY OF THE TR-10 IS REDUCED TO 8,000 lbs WITH THE USE OF THE CK-8,000 CASTER KIT.

Groves Heavy Duty Transport Rack.....\$2,199.00



## Groves Heavy Duty Transport Rack-4000lbs

Designed for transporting and storing product in your shop or on the job. Fork lift hoops mounted on sides. Bottom pads and uprights have full length rubber strips. Quick release mounting pins change the transport rack from mobile to stationary in less than a minute. Hot dip galvanized

TR4482 (Length:82", Width:44", LoadHeight:48", Height:58", Weight:540).....\$1,265

TR4496 (Length:96", Width:44", LoadHeight:60", Height:70", Weight:740).....\$1,595



## Groves Economy Transport Rack-2,000lbs

Economical cart designed for transporting and storing product in your shop on the job. 2,200 total capacity and fork lift hoops mounted on the sides. Includes hold down straps to secure material to cart. Bottom pads and uprights have full length rubber strips. Included casters with quick release mounting pins change the economy transport cart from mobile to stationary in less than a minute.

Groves Economy Transport Rack.....\$990.00

ETC8448 (Length:84", Width:36", LoadHeight:48", Height:57", Weight:301)

ETC8460 (Length:84", Width:36", LoadHeight:60", Height:69", Weight:321)

call for price





## Groves Single-Sided Truck Racks

Two sizes available, designed to transport all sizes of fabricated product. Rubber strips mounted on the bottom and back supports. Uprights mount in slotted holes for full depth adjustments. Upright have full length rubber strips and quick release hold down straps. Hot dip galvanized finished. Mounting pads front and back for bolting to truck floor. Heavy duty construction fabricated with 1 half inch square steel tubing. Ships knocked down, top A frame assembly is one piece bolted to the frame to save on the freight costs.

Groves Single-Sided Truck Racks .....call for price

- TRSS2482 (Length:82", Width:24", LoadHeight:48", Height:50.5", HodDowns:4, Weight:340)
- TRSS2496 (Length:96", Width:24", LoadHeight:60", Height:6.3", HodDowns:5, Weight:375)



## Groves Heavy Duty Shop Carts

- Rugged 4,000 lb. capacity.
- Rubber is mounted on bottom and upright supports.
- Ratchet straps are included to secure load.
- 8" diameter casters rated 1,000 lbs. each. Two rigid and two swivel with brake.
- Pull handle mounted on one end for maneuverability.
- Galvanized finish for long lasting durability

- HDSC48 (Length:54", Width:38", Load:48", Height:62", Weight:215) .....\$605.00
- HDSC8448 (Length:84", Width:40", Load:48", Height:63", Weight:360).....\$810.00
- HDSC8472 (Length:84", Width:40", Load:72", Height:87", Weight:460).....\$985.00



## Abaco Kitchen Processing Table

This processing table is designed to make your work more efficient. The table top tilts from being flat to varies degrees for you to work more comfortably. It can handle 1/2" slab easily. Its height can be adjusted from 29" to 39", length to 79" and tilts at 2 angles either 45 degree or 76 degree. It comes with removable casters that make the transportation easier. The collapsible designed to save on freight costs.

Abaco Kitchen Processing Table.....\$703.00

- Length: 79
- Width: 24
- Height: 39
- W.L.L.: 660
- Net Weight: 213



## Riold Cutting Table

While working with a professional such as you, we discovered that a multitude of problems around stone cutting, which cause material waste, missed deadlines and lost orders, stem from incorrectly designed or improperly build tables. We have designed our tables to support your business and not to hinder it.

- With hydrolic tilt .....\$9500
- With manual tilt .....\$7000

Dimensions: Width 10 ft, Height 32 in. (frame)  
 Power: 240V, 10Amps, 3Phs  
 Motor: 2Hp hydraulic pump motor  
 Easy installation and adjustment

Delivery: 6 weeks from the time of order placement  
 Shipping & Handling: Please contact us



## Wood's Powr Grip Stowaway Tilt Table

A GREAT SPACE SAVER IN THE SHOP  
 A FULL-SIZE CUTTING TABLE  
 The Stowaway features a generous work surface of 72-1/4" x 96-1/2" [1835 x 2450 mm] with a rugged, long-lasting felt top designed to reduce vacuum stick when used for cutting glass or other nonporous materials. High-strength construction provides durability without excess weight. Crossed support legs ensure a rigid and stable, 35" [889 mm] high work surface with a 500 lb [225 kg] load capacity.

Wood's Powr Grip Stowaway Tilt Table .....\$4,655.00



## 96in x 72in Crank Operated Slab Cart

- Heavy duty 8" rubber cast Tires with brakes, 500 lbs. capacity each
- 80° tilt with two safety pin locks
- Four slab holder wedges included
- 36" to 40" height adjustment
- 1,500 lbs. capacity
- Middle stabilizer bar on top is removable to use cart as a work table for sink cut outs.

Crank Operated Slab Cart .....\$1,995.00



## 96 by 72 inch Crank Slab Cart with Rollers

- Heavy duty 8" rubber cast tires with brakes, 500 lbs. capacity each
- 80° tilt with two safety pin locks
- Four slab holder wedges included
- Middle stabilizer bar on top is removable to use cart as a work table for sink cut outs.
- 36" to 40" height adjustment
- 1,500 lbs. capacity

Crank Slab Cart with Rollers .....\$2,499.00



## Abaco Working Table

Built in brackets allow you to create different work stations.  
Independent adjustable feet.  
Collapsible for ease of transport.  
Constructed of 18 gauge 2" x 2" square tubing

Abaco Working Table .....\$431.64

Dimensions:  
76 1/8 x 24 1/4 x 39 3/4 - 40 1/2"  
(1935 x 615 x 1010 - 1030mm)  
Loading Capacity: 660 lbs (300kg)  
Net Weight: 138 lbs (63kg)  
Net Weight With Casters:160 lbs (73kg)

MODEL WITH CASTORS COSTS AN ADDITIONAL \$75.00  
MODEL WITH CASTORS COSTS AN ADDITIONAL \$75.00



## Groves Adjustable Work Table

Two methods of leveling adjustment. Adjustable working height from 40" to 44". Ships knocked down for freight savings. Rubber mounted top to protect material. Large 36" opening provides easy access for grinding and polishing hard to reach sink cutouts.

Groves Adjustable Work Table .....\$655.00

Length 96"  
Width 28"  
Adj. Height 40-44"  
Weight 296



## Groves Stone Fabrication Table

- Lay out complete kitchens by attaching the tables together lengthwise or by attaching them on a 90 degree angle.
- Two built-in end clamps hold the tables together.
- Rubber is mounted on top and the sides where the carts clamp together.
- Four heavy duty 5" diameter swivel casters rated at 1,000 lbs. each.
- Four foot operated locks hold the table in place.
- Galvanized finish for long lasting durability.

DT2560 (Length:60", Width:25", Height:42", Weight:176)  
.....\$600





## Abaco Slab Rack

This Slab Rack is ideal for shops with limited storage as it can handle many pieces of different sized materials. The rack consists of two 10ft. steel bases and 20 poles with rubber caps to protect the stored material. Square Pole: 2 x 2 x 59" (50 x 50 x 1500mm), Between poles, Max Capacity: 6000 lbs (2727kgs)

- Loading Capacity Per Set: 30,000 lbs (14,000kgs)

Abaco Slab Rack.....\$1,097.00

Length : 118 5/8" (3012mm)  
 Width : 6 3/4" (172mm)  
 Height : 59 3/8" (1510mm)  
 Distance Between Poles: 7 inches (180mm)  
 Between Posts, Max Capacity : 6000 lbs (2727kgs)  
 Loading Capacity Per Set : 30,000 lbs (14,000kgs)  
 Weight Per Set With Rubber : 720 lbs (327kgs)  
 Weight Per Set Without Rubber: 651 lbs (296kgs)



## Abaco Adjustable Backsplash Brackets

Brackets are designed for storing and displaying backsplash slabs. The Brackets come in a set of 2 that fit perfectly onto the Abaco Slab Racks. With easy to turn knobs, these brackets are adjustable at various heights that will accommodate all sizes of backsplash slabs.

Abaco Adjustable Backsplash Brackets .....call for price

Length: 22 5/8  
 Width: 5 1/8  
 Height: 7  
 Net Weight: 4.4 lb  
 W.L.L.: 396 lb

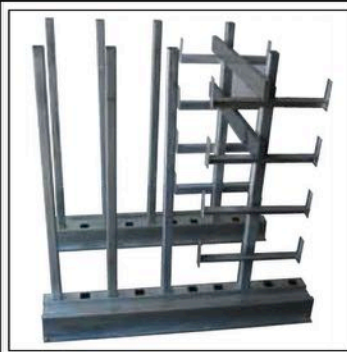

## Groves BSBPKG-1 Back Splash Bracket Package

One row with four levels of back splash storage. Three posts on each rail provide two 12" wide sections between the posts for stone storage. Parts included in the package: 2 Bundle Rails, 8 Back Splash Brackets, and 8 60" Posts. Total weight 350lbs.

Back Splash Bracket Package .....\$656.00



## Universal Storage System

Outside rails are constructed of extruded aluminium, to provide a strong but lightweight storage solution. Easily store cutoffs, finished products, remnants, and vanity tops in a convenient organized manner. Outside rails are designed with slots to hold 2 x 4's. Rails are 6" wide x 3" high x 60" long and can butt together for desired length. Posts are 1" in diameter steel, coated with a galvanized finish. Post can be removed for easy unloading of product.

Universal Storage System.....\$325.00

Length 60"  
 Openings 14  
 Description 2 Outside Rails and 30 Posts

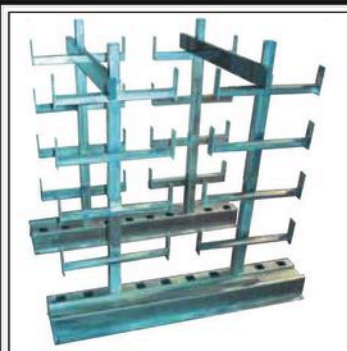

## Groves BSBPKG-2 Back Splash Brackets Package

Two rows with four levels each provide eight levels of back splash storage. Parts included in the package. 2 Bundle Rail, 16 Back Splash Brackets, 4 60" Post.

Back Splash Brackets Package.....\$768.00



## Omni Cubed : Mega-Jaw™ Carry Clamp

The Mega-Jaw™ Carry Clamp has been designed for easier and safer carrying of countertops. The lightweight clamp (only 2.6 pounds) opens wide enough to accommodate tops up to 2.6" (66mm) thick! The clamp features high-strength aluminum arms, and non-marking, tear resistant rubber gripping pads. To distribute the weight of very heavy countertops, two installers per clamp can be used on each side of the top (four people total). The tension in the clamp is adjustable to allow the clamp to "hold on" to the top when not in use (won't fall off). Each pair of clamps has a rated capacity of 500 pounds, and the more weight lifted, the tighter the clamps grip. All Omni Cubed products are engineered, manufactured, and assembled in the USA and are covered by a one-year manufacturer's limited warranty.

\$265



## Omni Cubed : Aqua-Jaw™ Carry Vise Pair

The Aqua-Jaw™ Carry Vise™ has been designed for easier and safer carrying of countertops. Making it's debut at Coverings this year, the new Aqua-Jaw™ Carry Vise™ by Omni Cubed is the only "all-weather" carry vise that won't slip off wet (or dusty) countertops. Not the typical carry clamp, the Aqua-Jaw™ is also usable on stairs and other slanted install terrains (won't slip at any angle). Dual, "quick-spin" tightening handles quickly secure the product, and two to four installers are able to safely lift and carry countertops up to 2.7 inches thick (800 pound capacity per pair). The Aqua-Jaw™ Carry Vise™ is manufactured and assembled in the USA and is covered by a one-year manufacturer's limited warranty.

\$475



## Omni Cubed : Pro-Cart AT1

The Pro-Cart AT1 provides a solution to the challenges associated with large and cumbersome countertop installation carts. The cart is constructed from aluminum tubing, so it is strong and lightweight at less than 50 pounds. Important for climbing stairs, the cart stays attached to the countertop when lifted and the 8" casters allow resting on stair treads. Pneumatic casters dampen vibrations and enable travel across rough terrain such as gravel or lawns. The wheelbase makes the cart very stable, even with large tops, and the cart's high ground-clearance allows "popping of wheelies" over larger curbs. In many cases, one person can push and maneuver the cart by themselves.

\$650



## Omni Cubed : Pro-Cart AT2

The Pro-Cart AT2 is Omni Cubed's new generation all-terrain countertop installation cart! The AT2 includes the same features as the popular AT1 model, with even more benefits. The AT2 features collapsible clamp uprights for easy countertop removal and tilting of large stone pieces onto cabinets. Climbing stairs with the AT2 is even easier due to the innovative adjustable wheel base (the distance between the cart's front and back wheels has 4" of sliding adjustment to match varying depths of stair treads). For ease of storage and sliding down the center of A-frames, the included folding kit and collapsible uprights enable folding of the AT2 into a very compact design. The AT2 features large 10" casters, has a rated weight capacity of 1,000 pounds, and still weighs in at less than 65 pounds!

\$1125



## Omni Cubed : Pro-Dolly

The Pro-Dolly provides easier transport and installation of countertops, and is especially helpful when used in pairs for very tall, extremely heavy, or extra large countertops. This square-tube aluminum dolly features a lightweight and compact design which weighs only 20 pounds, yet has a rated capacity of 750 pounds (1500 pounds when used in pairs for very large tops). The low profile dolly (only 5.25" from the support rail surface to the ground) allows rolling of tall tops through doors. The dolly features four, 8", flat-free, closed-cell polyurethane tires which exhibit excellent shock absorption. The support rail is lined with durable rubber to prevent chipping, and countertops are secured with an integrated clamp (useful when climbing stairs, the dolly stays attached).

\$350





## Omni Cubed : Seam Setter VCA with Auto Pump

The automatic Seam Setter VCA is a worry-free solution for achieving high-quality seams. Large 6" cups handle heavy stone tops with ease. The powerful, yet compact, vacuum pump maintains pressure for all cups and operates on AC Power or a single 9V battery (for installations where electricity is not available). The working area is easily accessible while the seam setters are in place, so removal is not needed in order to apply epoxy or scrape the seam. The seam levelers slide on rails for custom placement on both sides of the seam, and feature non-spinning feet to prevent scratching of surfaces.

\$725



## Omni Cubed : Seam Setter VCM

The Seam Setter VCM is an installation tool used for joining seams, leveling seams, and stabilizing backsplashes. Please be cautious of cheaply made "look-alike" copies of our seam setters. Omni Cubed is unmatched in quality, price, warranty, and service.

\$265

- One tool investment, three uses!
- Achieve high-quality, even seams
- Durable, long-lasting components
- Reliable, full-contact vacuum cups
- Non-spinning, leveling feet with vinyl caps prevent scratching of surfaces
- Deeper 6" cups provide longer and stronger holding power



## Omni Cubed: Automatic Stealth Seamer™

The product features strong 8" vacuum cups which provide full-contact reliable hold, and the powerful, yet compact, vacuum pump maintains pressure for all cups and operates on AC Power or a single 9V battery (for installations where electricity is not available). Countertop seams easily open and close by use of a smooth-turning knurled roller, and the working area is open and accessible with the units in place (removal is not needed in order to apply epoxy or scrape the seam). Four leveling components per seam setter allow "fine-tune" adjustment on both sides of the seam, and they feature non-spinning, leveling feet with vinyl caps to prevent scratching of countertop surfaces. The eight leveling points provide total control along the entire seam to eliminate the unevenness caused by crowned countertops.

\$995



## Omni Cubed: Automatic Stealth Seamer™

The Sink Hole Saver™ by Omni Cubed is an innovative stiffening device that protects finished stone pieces from breakage during lifting, transport and installation.

The Concrete Edition Sink Hole Saver™ clamps thicker 1.25" to 2.5" edges. The product is an ideal solution to strengthen countertops and backsplashes, especially fragile stone pieces.

The Sink Hole Saver™ features mechanical clamps, which stay secure around finished edges. Large, easy-grasp clamp knobs make the clamps effortless and quick to tighten. The stiffening rail is very strong, yet light-weight, and features a convenient sliding channel for custom placement of each clamp. Sink Hole Savers can be applied in the shop and left on the countertop all the way to and through the install!

Available in 4, 6, and 8 ft. lengths



4'	.....	\$220
6'	.....	\$295
8'	.....	\$330



# GET THE **AARDWOLF** AADVANTAGE

The worlds safest Lifter is even safer with the support bracket



12" Jaw  
Auto Grip  
Lift 3,300 lbs  
Monumental

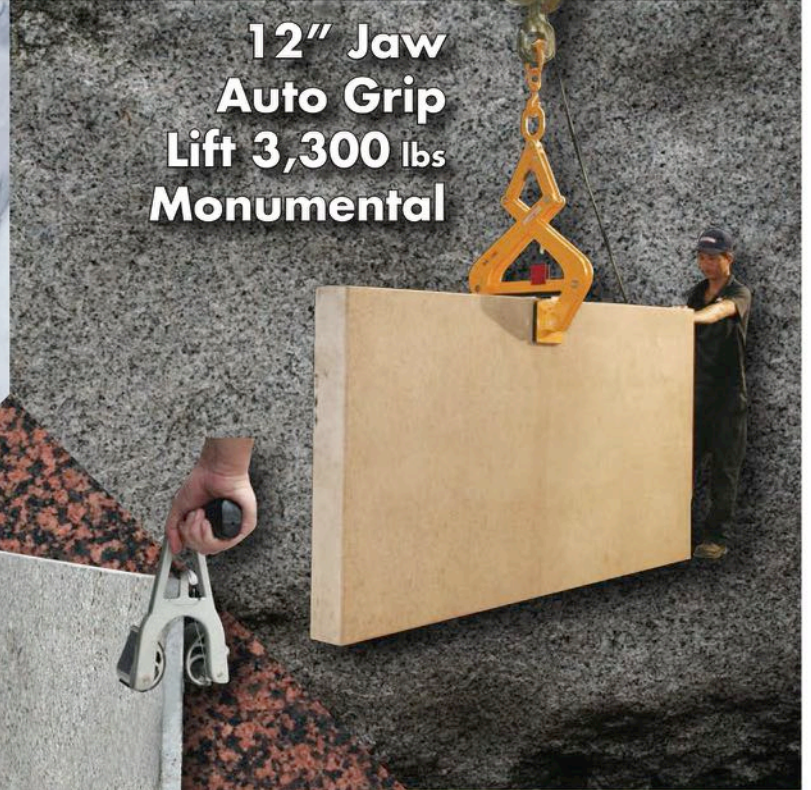

Polished or  
Rough Stone.  
Horizontal or  
Verticle Lift  
2200 lbs

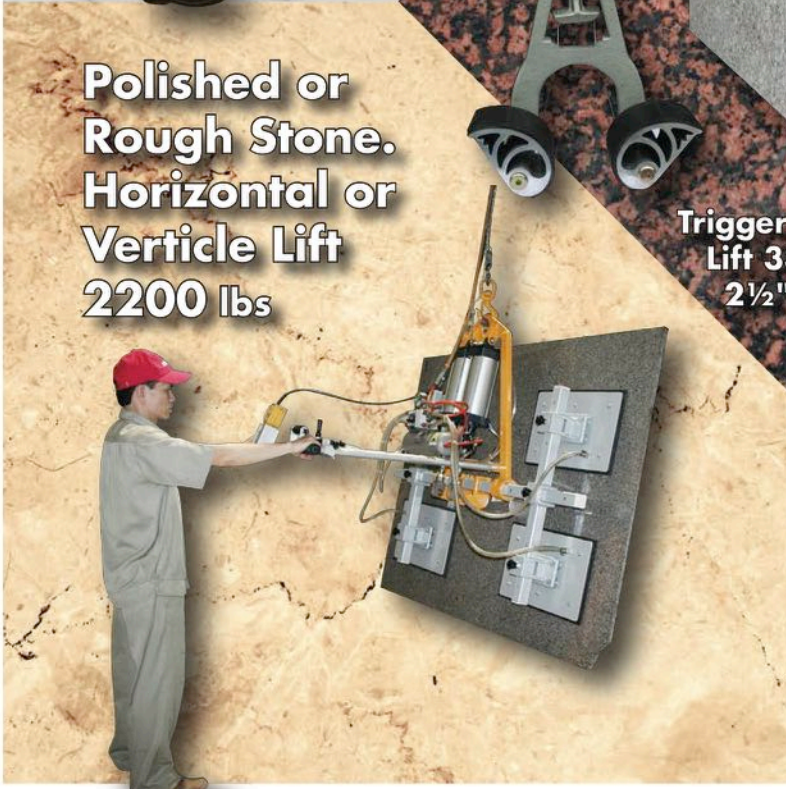

Trigger Grip  
Lift 330 lbs  
2½" Jaw

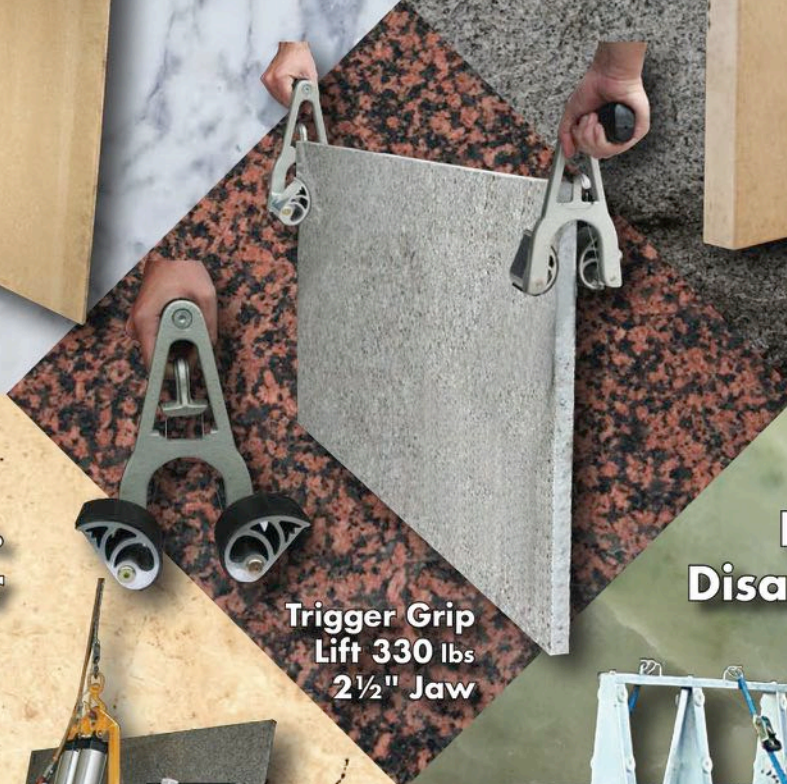

Economic  
Lightweight  
Disassemblable



**Made from the highest quality materials & processes for maximum safety, without compromise.**





## MK Diamond MK-1503 Air Polisher

MK Diamond's rear exhaust pneumatic polishing tool is designed for continuous production applications. Lightweight and compact, the MK-1503 Air Polisher is one of the most durable tools of its kind on the market for polishing stone. The water-tight sealed bearings provide long life and smooth rotational speeds. The water and air controls on the tool are simple to use and located for operator convenience. This tool's versatility allows for 3, 4, and 5 inch discs to be used. The air vent is at rear of tool so that exhaust is carried away from operators' hands by the hose protector. The MK-1503 Air comes comes with 25' water hose, 5' air hose, 3' air/water hose protector, and side handle, wrenches. The MK-1503 Air kit also includes 4" resin polishing disc set, hard rubber back plate disc, and carrying case.

Call for price

Air Consumption 16 cfm / 0.45cmm  
 Air Pressure 90 psi, RPM 5,500 (free speed)  
 Shaft 5/8"-11, Air inlet 1/4" Npt  
 Length 10-1/4 in. (261mm), Vibration 2.5 M/Se  
 Sound (Min.) 92.3 db, Sound (Max) 104.9 db  
 Air Compressor Required 5 HP (min.)  
 Max. Pad Diameter 5" (127mm)



## Alpha® AIR-658 Air Polisher

Alpha® AIR-658 is a lightweight tool that accepts 3", 4" or 5" discs. It is a "plug and play" tool, which includes the side handle, a splashguard, pneumatic lubrication oil, and the hoses for air, water and exhaust along with the appropriate fittings. With sealed bearings to increase life and a rear exhaust system, Alpha® AIR-658 is designed to last a long time. Requirements for this tool are a cast iron 2 stage compressor, a large reservoir, 5 HP for each tool. Air consumption is 15 CFM and required air pressure is 85-95 PSI. With a weight of only 2.64 lbs, Alpha® AIR-658 is the best addition to any stone shop.

Call for price

Air Consumption:15CFM, Air Pressure:85-95 PSI  
 Speed (no load):3,500RPM, Weight:2.64lbs/1.2kg  
 Spindle:5/8"-11, Air Inlet:1/4"Npt

Equipment Included: • Air Lead Hose - 10' (3m) • Exhaust Muffler • Side Handle (reversible) • Lubrication Oil • Faucet/Garden Hose Adapter • Wrenches/Splash Guard • C-Handle



## Alpha Air-300 Pneumatic Polisher

Introducing the Alpha AIR-300, designed for unique applications that are difficult to accomplish using conventional polishers. A smaller version of the well-known Alpha® AIR-658, the AIR-300 is ergonomically designed to fit comfortably in your hand and only weighs 1.6 pounds reducing fatigue from long hours of polishing. The smaller design is easy to maneuver and produces flawless sink rims and bowls. The Alpha® AIR-300 accepts 3" and 4" discs along with 2" and 3" rubber pads. It requires a 3HP compressor with air consumption of 10 CFM and air pressure between 85-95 PSI. The Alpha® AIR-300 Polisher easily converts from in-shop to on-site; a must have for all fabricators!

Call for price

Air Consumption 10cfm  
 Air Pressure 87psi  
 Max. Speed with no load 5800 rpm  
 Weight 1.60lbs  
 Spindle 5/8"-11 thread  
 Air Inlet 1/4"  
 Water Inlet 1/4"



## Barranca BD-2321WR Air Polisher

This rear exhaust, pneumatic wet polishing tool is designed for continuous production applications and improved safety. Lightweight and compact, this tool provides the operator with increased comfort and reduced fatigue. Cast from aircraft aluminum, the BD-2321WR is one of the most durable tools of its kind on the market for polishing stone. The water-tight sealed bearings provide long life and smooth rotational speeds in all operating conditions. The water and air controls are simple to use and conveniently located. Exhaust is vented at the rear of the tool and carried away from the operators' hands by the hose protector. The BD-2321WR comes with 25' water hose, 5' air hose, 3' air/water hose protector, D-handle, wrenches. (Backer pad not included). Full manufacturer's warranty.

Call for price

Air Pressure 90 psi, RPM 250 to 5500  
 Shaft Thread 5/8"-11, Air Inlet 1/4" Npt  
 Output 320 W, Length 10-1/4 in.  
 Air Consumption 16 cfm (min)  
 Air Compressor Required 5 HP min.  
 Max. Disc Size 5", Weight 4 lbs.



## Oscillating Multifunction Power Tool

This easy-to-use multifunction hand tool oscillates 2100 times a minute. Perfect granite and marble countertop finishing. You can get this tool in to surface corners that other radial hand machines could not reach. Durably made with die cast aluminum gear housing. Comes with sealed bearing for longer life.

Oscillating Multifunction Power Tool.....\$39.00

- 2100 oscillations per minute
- 1/4 horse power
- 1.8 amps
- 120 volts
- 6ft power cord
- 9" x 3" dimensions
- 3.3lbs weight

**FLEX**  
Das Original

## Flex Hand Machines

FLEX Power Tools manufactures heavy-duty power tools for all types of natural stone (granite, marble, slate, onyx, limestone) concrete, asphalt, brick and cinder block, as well as grinders and polishers for the metals and automotive industries.

FLEX has the industries most complete line of wet and dry products for angle grinding, flat grinding, edge milling, drilling, core drilling, sawing, sanding and polishing.



Flex LDC 1509 FR 5" Concrete Grinder



Flex L 3406 VRG 5" Variable Speed Grinder



Flex LW 1509 4-1/2" Wet Grinder



## Amigo S9 Pneumatic Water Polisher



We think that the Amigo S9 Air polisher is the most economical and functional air polisher on the market today. Operating on only 8 CFM of air pressure, the Amigo S9 is light weight, ergonomic, and durable.

This versatile pneumatic water polisher can be used for any hard or soft material and can easily profile sand stone to granite and everything in between.

FREE Ground Shipping available

\$143

Includes side handle, water hose, oil, wrench, and 3" backer pad.

- Air pressure : 6~7kg/cm2 (8cfm at 90psi)
- Speed : 4,500 rpm
- Grinding Wheel : 3-1/8"
- Spindle : 5/8 - 11 thread



## Weha QB9 Rear Exhaust Air Polisher

\$276.00



Made with upgraded premium bearings for extra life. Light weight. Comes with Wrench, side handle, front handle water guard, air hose, and water hose. 90 day warranty.

- Rear exhaust muffler
- Reversible side handle
- Spindle-thread: 5/8-11"
- Air required: 16cfm @ 90 psi
- Weight: 3.5 lbs
- Front handle T-Grip
- Center water feed
- Max speed: 4500 rpm



## Amigo B10 Orbital Polisher

Amigo Orbital Water Sander & Polisher will give swirl-free finish on concrete counter tops or floors. This unit will grind, sand, polish, or buff using diamond polishing pads or any other adhesive-backed diamond products.

Power: 3hp/110V  
RPM: 2200  
Weight: 40bs

Amigo B10 Orbital Polisher.....\$1,440.00



## Makita Sander GV5000

- \* Lightweight for easy operation
- \* Powerful motor for maximum sanding
- \* Ball and needle bearing construction for long life
- \* Double insulated. INCLUDES : 1 Each Abrasive disc. #80(742109-9), Plastic pad (743025-8), Side handle (273406- 7), Hex wrench (783203-8).

Makita Sander GV5000.....Call for Price

- \* Sanding disc. 5" (12mm)
- \* No Load speed 4,500 rpm
- \* AMPS(115V) 3.6
- \* Overall length 7-1/8" (180mm)
- \* Net weight 2.6 lbs (2.2kg)
- \* Shipping weight 4lbs. (3.4kg)



## Makita 5 inch Angle Grinder 9564CV

5 stage variable speed control dial for matching the RPM to the work. Improved 12 AMP motor design for increased output power in a more compact tool. Larger and improved carbon brush material for longer tool life. Electronic limiter stops the motor and prevents accidental motor overload and burnout. "Tool-less" wheel guard adjustment for easy clamping. Labyrinth construction seals and protects the motor and bearings from dust and debris by creating a complex set of channels.

Full manufacturer's warranty.

Makita 5 inch Angle Grinder 9564CV.....Call for Price

INCLUDES:  
5" Grinding Wheel  
Lock Nut Wrench (782412-6)  
Side Handle (152490-4)  
Lock Nut (224566-8)  
Inner Flange (224368-2)



## Makita PW5001C Wet Stone Polisher

3 holes at the spindle top evenly spread water to the pad and prevents the pad from clogging. Overload switch to protect armature failure. Includes a ground fault circuit interrupter (GFCI) plug. Pre-setting dial (2,000 - 4,000 RPM) for optimum rotating speed. Powerful 7.9 AMP motor and lightweight (4.6 lbs.), High power-to-weight ratio (1.72) for reduced operator fatigue. Soft-Start feature for smooth start-up; variable speed. Housing cover protects the industrial die cast aluminum gear housing.

Makita PW5001C Wet Stone Polisher.....Call for Price

Polishing Disc  
4", No Load RPM 2,000 - 4,000  
AMPS 7.9,  
Spindle Thread (11 UNC) 5/8  
Length 12-1/4"



## MK-1503-SS Wet Polisher

MK-1503SS wet polisher is ideal for handheld grinding and polishing of gemstones, rock materials, marble and granite. The handheld grinder easily attaches to a standard hose to enable the unit to dispense a steady flow of water through a control valve to the work piece. The MK-1503-SS comes with water hose, GFCI, D-handle, side handle, gear box cover, carrying case and spanner wrenches. The MK-1503SS Kit also includes 4" resin polishing disc set and a 4" rubber backer pad

MK-1503-SS Wet Polisher.....Call for Price

Power 800W , 120V  
Amps 7.9  
RPM 3,200  
Shaft 5/8"-11"  
Max. Pad Diameter 5"  
Weight 6lbs





## TEQ-SHINE Wet Polisher

The Diamond Tool Store brings you the best selling combination for wet hand polishers with DITEQ's TEQ-SHINE Wet Polisher. With its powerful 650W, variable speed 800-3600rpm motor, you can use it for any stone fabrication job that is big or small. This high quality wet polisher is made in Korea.

- ☐ Variable Speed
- ☐ Professional grade
- ☐ Powerful 650W motor
- ☐ Heavy-duty components
- ☐ Wear resistant die-cast aluminum gear cover
- ☐ Crack-resistant engineered nylon body
- ☐ Convenient spindle lock
- ☐ Lightweight and compact design
- ☐ Easy-to-change carbon brushes

Outside Dia. of Disc: 4"  
 Watt/AMPs: 650W/6AMPs  
 No load speed: 800-3600/min  
 Spindle: 5/8"-11unc 7/8" arbor  
 Model: TS4V  
 Spindle: 5/8"-11  
 Weight: 6.17 lbs  
 Part #: M00019

TEQ-SHINE Wet Polisher.....\$199.00



## Alpha® VSP-120 Variable Electric Polisher

Once again, Alpha® has set a new standard for the wet polishing application. As an option, our newest wet polisher comes with step-down gear set to reduce spindle RPMs. Together with the variable speed control switch, you can set any speed range between 500 RPMs to 2,800 RPMs.

Unlike competitive products in the industry, there is no limit on the usage of slow RPMs. Alpha® researched the polishing application of engineered stone and realized the benefits of slower RPMs to avoid the risk of burning resin. Every engineered stone fabricator should try our new variable speed wet polisher to achieve the next level of quality and performance.

Call for price

Rating:110/220 Volts, Amperage:7.8/3.9, Power:800 W  
 Speed (Variable):500~2800 RPM, Weight:6.96lbs  
 Spindle:5/8"-11

Included:• Ground Fault Circuit Interrupter • Water Valve and Hose • Faucet/Garden Hose Adapter • Wrench • C-Handle • Side Handle (reversible) • Extra Carbon Brush Set • Ventilation Cap • Carrying Case



## Alpha AWP-158 Electric Polisher

This 7.8 amp, 800-watt, 3,000 RPM machine is a powerful work-horse suitable for use in the shop or on the job site. The AWP-158 features several improvements over previous generations of polishers. In addition to the increased power and spindle speed, there are two types of handles included: a side handle for edge profiling and polishing and a "C" handle for core drilling and flat surface polishing. There is a flat polishing caster designed to improve stability during scratch removal operations for a better final finish. The AWP-158 is double insulated and equipped with a power cord that is 10 feet long and has a built-in GFCI (Ground Fault Circuit Interrupter) for safety.

Call for price

Rating:110/220 Volts, Amperage:7.8/3.8  
 Power:800 W, Speed (no load):3,000 RPM  
 Weight:6lbs/2.72 kg, Spindle:5/8"-11/M14

Equipment Included: • Ground Fault Circuit Interrupter • Water Valve and Hose • Faucet/Garden Hose Adapter • Wrenches • C-Handle • Side Handle (reversible) • Extra Carbon Brush Set • Caster Assembly



## Alpha® Ecoguard Type G

Dust Collection Cover for Grinding

Alpha® introduces a new Ecoguard designed for collecting dust when using the Alpha® HSG-125 or other High-Speed Angle Grinder. The Ecoguard Type G is intended for use when grinding with wheels up to 5" in diameter. It is made of high-quality construction for heavy-duty applications. This dust collection cover creates a virtually dust-free environment when connected to a vacuum. Available Now!

Ecoguard Dust Collection Cover Type G .....\$99.20  
options  
with Flexible Connector Hose 18" .....add \$14.95  
Ecoguard G + Connector Hose Kit .....add \$5.77

## Your Safety When Using Diamond Tools

**WARNING:** Comply with all cautions and warning provided by the saw manufacturer. All diamond blades should be used in compliance with ANSI Safety Code B7.1: Wear eye protection, examine all machinery and equipment for beginning operation and handle ALL equipment and machinery according to the manufacturer's regulations.

**WARNING:** Careless or improper used of a diamond blade could cause personal injury. Observe the following precautions and tool manufacturer's instructions for using tools and diamond blades.



1. Before use, examine all blades for cracks and other damage. Do not use if damage is suspected. Damaged, incorrectly mounted and/or misused blades are extremely dangerous to use.
2. Always wear proper safety equipment i.e. safety footwear, safety goggles, snug fitting clothing, hearing and head protection and proper respiratory equipment.
3. Always use wheel guard and check for proper function of all guards on the tool. Never pull guards back, remove them, or leave them in open position.
4. Be sure that the arrow on the blade points in the same direction of rotation of the tool.
5. Be sure that the blade washers/flanges are correctly assembled on the shaft and that the blade is properly supported. Do not use blades that rattle or wobble on the tool.
6. Do not alter the hold in the blade. This creates an unbalanced blade rotation resulting in wobbling, pounding or cracking which is hazardous.
7. Inspect flanges for warpage, cleanliness, burrs, and flatness.
8. For safe operation, use flanges which are at least 1/4 diameter of the blade.
9. Make sure the no-load RPM on the tool's name plate does exceed the speed marked on the blade.
10. Before performing any cutting operations let the tool run for few seconds without load. If the blade wobbles, vibrates or unusual noise occurs, stop the tool immediately. Examine the blade for damage or incorrect mounting.
11. Do not stand in line with the blade or the stream of hot particles.
12. Keep bystanders and/animals out of the work space.
13. Maintain a firm grip on the tool during cutting operation.
14. Slow feed speeds are recommended. Do NOT force the tool.
15. The diamond blade is intended for straight line cutting only. Cutting curves will cause stress cracks for fragmentation on the blade, resulting in possible injury to people in the vicinity.
16. Do not use side pressure or grind with the side of the diamond blade.
17. Examine blades carefully before each use for proper alignment and possible defects.
18. Make sure all users of the blade comply with safety regulations.





## Core Drill Presser

Heavy duty core drill stand is made with metal and has suction cups under the base for steady drilling. 4" hole is made to be filled with water to be used while drilling. The motor swivels 90 degrees allowing access to hard to reach corners.

Power: 110v/6amp, RPMs: 750, Maximum bit diameter: 4 inch, Maximum bit depth: 4 inch, Weight: 22lbs.

Core Drill Presser .....\$730.00



## Core Drill Stand

Comes with suction cup base. Easily attach and hand drilling machine.

Core Drill Stand .....\$270.00



## Multiquip CDM1H Hand-Held Core Drill

The CDM1H serves as a multiple application unit. Use it for wet drilling jobs up to 3 inches (75 mm) in diameter, or with our Cobra bits (wet or dry) up to 5 inches (127 mm).

Multiquip CDM1H Hand-Held Core Drill .....\$570.00

- Convenient adjustable shoulder rest
- Three-position hand grip
- Internal water feed
- Internal slip clutch
- Carry case and tools included
- External circuit breaker



## Hellcat CSN-3AH 3 inch Core Drill

- Powerful 2400W motor.
- Dual high performance speed 1400/2100 rpm.
- 2"-3" holes at 1400 rpm.
- 1"-1.5" holes at 2100 rpm.
- U.S Patented full 120° (+-60°) Angle Column Base (optional).
- Light-weight durable aluminum frame.
- Durable wear-proof Teflon sliding plate carriage.
- Ceiling Jack frame for easy setting and removal of motor.

Standard Column .....\$1,370.00  
 120 Deg Angle Column .....\$1,620.00

Capacity 1" - 3", Current (A) / Input (W) 20.0 A/2400 W,  
 Frequency 50/60 HZ, Revolutions / Min (RPM)  
 Low: 1400/min, High: 2100/min  
 Motor Weight (lbs) 32.68 lbs  
 Column Height (lbs) 30.9"  
 Column Weight (lbs) 14.2 lbs.



## Hellcat CSN-6A 6 inch Core Drill

- Powerful 2100W motor.
- High performance speed 820 rpm.
- 6" holes at 820 rpm.
- U.S Patented full 120° (+-60°) Angle Column Base (optional).
- Light-weight durable aluminum frame.
- Durable wear-proof Teflon sliding plate carriage.
- Ceiling Jack frame for easy setting and removal of motor.
- Easy to read horizontal gauge.

Standard Column .....\$1,150.00  
 120 Deg Angle Column .....\$1,450.00

Capacity 6", Current (A) / Input (W) 17.5 A/2100 W  
 Frequency 50/60 HZ, Revolutions / Min (RPM) 820/min  
 Column Height 30.9", Motor Weight (lbs)24.9 lbs.  
 Column Weight (lbs) 14.3 lbs.



## Hellcat CSN-10A 10 inch Core Drill

- Powerful 2400W motor.
- Dual high performance speed 470/1100 rpm.
- 10" holes at 470/1100 rpm.
- U.S Patented full 120° (+-60°) Angle Column Base (optional).
- Light-weight durable aluminum frame.
- Durable wear-proof Teflon sliding plate carriage.
- Ceiling Jack frame for easy setting and removal of motor.
- Easy to read horizontal gauge.

Standard Column.....\$1,400.00  
 120 Deg Angle Column.....\$1,690.00

Capacity 10", Current (A) / Input (W) 20.0 A/2400 W  
 Frequency 50/60 HZ, Revolutions / Min (RPM) Low: 470/min, High: 1100/min  
 Column Height 33.9", Motor Weight (lbs)34.2 lbs.  
 Column Weight (lbs) 17.6 lbs.



## Hellcat CSN-12A 12 inch Core Drill

- Powerful 2500W motor.
- Dual high performance speed 360/850 rpm.
- 12" holes at 360/850 rpm.
- U.S Patented full 120° (+-60°) Angle Column Base (optional).
- Light-weight durable aluminum frame.
- Durable wear-proof Teflon sliding plate carriage.
- Ceiling Jack frame for easy setting and removal of motor.
- Easy to read horizontal gauge.

Standard Column.....\$1,860.00  
 120 Deg Angle Column.....\$2,180.00

Capacity 12", Current (A) / Input (W) 20.8 A/2500 W  
 Frequency 50/60 HZ, Revolutions / Min (RPM) Low: 360/min, High: 850/min  
 Column Height 38.6", Motor Weight (lbs) 40.1 lbs.  
 Column Weight (lbs) 33.5 lbs.



## Hellcat CSN-14A 14 inch Core Drill

- Powerful 2700W motor.
- Dual high performance speed 300/700 rpm.
- 14" holes at 300/700 rpm.
- U.S Patented full 120° (+-60°) Angle Column Base (optional).
- Light-weight durable aluminum frame.
- Durable wear-proof Teflon sliding plate carriage.
- Ceiling Jack frame for easy setting and removal of motor.
- Easy to read horizontal gauge.

Standard Column.....\$2,090.00  
 120 Deg Angle Column.....\$2,280.00

Capacity 14", Current (A) / Input (W) 22.5 A/2700 W  
 Frequency 50/60 HZ, Revolutions / Min (RPM) Low: 300/min, High: 700/min  
 Column Height 38.6", Motor Weight (lbs)41.0 lbs.  
 Column Weight (lbs) 33.5 lbs.



## MK-130/3 3-Speed Wet Core Drill

- Three-speed gearbox
- Slip clutch
- Built-in water swivel
- Thermal overload switch
- Overload indicator light
- Ground Fault Interrupter
- Metal carrying case

MK-130/3 3-Speed Wet Core Drill.....\$1,595.00

Motor 110V / 16 Amps, Load Speed 1st Gear 600 RPM  
 Load Speed 2nd Gear 1,300 RPM  
 Load Speed 3rd Gear 2,800 RPM  
 Connecting Threads 1-1/4"-7 5/8"-11 G1/2"  
 Weight 16 lbs. (7.5 kg)  
 Drilling Capacity 3" (hand-held)  
 6" (rig mounted)



## Multiquip CDM2CSA Core Drill

Core drill rigs are designed to work with heavy-duty core drills. These column and base assemblies feature wheels for easy movement. They can be bolted to a wall or floor or be used with optional vacuum system for added versatility. Smaller bases excel in confined drilling areas while angled bases are used anywhere angled drilling is required.

Multiquip CDM2CSA Core Drill.....\$580.00

Lightweight drill rig for confined drilling areas and smaller applications  
 Aluminum column  
 Adjustable angle base capable of 45 degrees  
 Left- or right-hand operation  
 Can be used with optional vacuum pump (CDMVP) or bolt down  
 Recommended drill for this stand: DM15A9C





### Multiquip CDM3CS Core Drill

Core drill rigs are designed to work with heavy-duty core drills. These column and base assemblies feature wheels for easy movement. They can be bolted to a wall or floor or used with optional vacuum system for added versatility. Smaller bases excel in confined drilling areas while angled bases are used wherever angled drilling is required.

Multiquip CDM3CS Core Drill.....\$655.00

Full size drill rig with quick release motor mounts  
 Aluminum column  
 Straight mast  
 Left- or right-hand operation  
 A 10-inch (254 mm) core bit capacity or 12 inches (305 mm) with use of optional adapter block CDM3SP  
 Can be used with optional vacuum pump (CDMVP) or bolt down. Recommended drill for this stand: Milwaukee 4096; Milwaukee 4094 or DM15A9C with optional CDM3SP adapter block



### Multiquip CDM3CSA Core Drill

Core drill rigs are designed to work with heavy-duty core drills. These column and base assemblies feature wheels for easy movement. They can be bolted to a wall or floor or used with optional vacuum system for added versatility. Smaller bases excel in confined drilling areas while angled bases are used wherever angled drilling is required.

Multiquip CDM3CSA Core Drill.....\$800.00

Full size drill rig with quick release motor mounts  
 Aluminum column  
 Adjustable angle base capable of 45 degrees  
 Left- or right-hand operation  
 A 10-inch (254 mm) core bit capacity or 12 inches (305 mm) with use of optional adapter block CDM3SP  
 Can be used with optional vacuum pump (CDMVP) or bolt down  
 Recommended drill for this stand: Milwaukee 4096; Milwaukee 4094 or DM15A9C with optional CDM3SP adapter block



# ABACO MACHINES

Abaco Machines, the leader in stone and glass lifting equipment. With years of research and development, our products are engineered to be the safest, easiest to use and most reliable in the industry.



## Amigo MX1250 Mini Profiling Router

Now with MAKITA 9565CV!

Looking for an ultra light portable router for your profiling needs? Then this might be the perfect mini router for you, weighing only 20lbs! Just like all our other Amigo profiling routers, this features a Hydro-Float base that gets rid of troublesome rollers. The Makita 9565CV is proven to be reliable!

Power: 12A/120V  
Rev. speed: 2800-10500rpms  
Weight: 20lbs

FREE Ground Shipping on ALL Amigo Routers.

Amigo MX1250 Mini Profiling Router.....\$899.00

## Amigo M2 Stone Router

The ORIGINAL AMIGO M2 STONE ROUTER is first the light duty router machine on the market to offer ~3 horsepower with TRUE Variable Speed Control. It's TRUE 0-8500rpm range makes it perfect for polishing as well as cutting & grinding. Weighing only 35lbs & with a simple three prong power adapter, the Amigo M2 is very easy to use at any job site. The power of the ORIGINAL AMIGO M2 STONE ROUTER will allow you to profile stone up to 3 inches thick, this capability is unrivaled in the fabrication trades.

Voltage: 110V  
Power: ~3hp/2000w/16amps,  
No Load Rev Speed: 0-8500 TRUE Variable Speed Control  
Max. Stone Thickness: 40mm,  
Max. Bit Diameter : 100mm,  
Weight: 35lbs

FREE Ground Shipping on ALL Amigo Routers.

Amigo M2 Stone Router.....\$1,880.00



## Amigo CP1 "THE TANK" Stone Router

**INDESTRUCTIBLE ROUTER!**

Amigo offers variety of stone profiling routers for your different stone edging needs. Amigo CP1 is a special router targeted towards customers who need a reliable router with a single speed motor. Of course, Amigo CP1 stone router has a widely known Hydro-Float base that gets rid of mechanical rollers.

Input: Single Phase 110v  
 Output: 2hp  
 Rotation: Single Speed 3450 rpm's  
 Weight: 78lbs

FREE Ground Shipping on ALL Amigo Routers.



Amigo CP1 "THE TANK" Stone Router.....\$1,750.00

## Amigo M4S Stone Router

Amigo M4s Edging Machine is perfect for almost all of your profiling needs. It takes 1 PHASE 220V power input and produces continuous 2 horsepower 3 PHASE heavy duty output. 3 PHASE, 2 horsepower output produces smooth torque from initial startup to higher revs and last longer with extreme abuse than any other 1 PHASE motor in the market. Amigo M4s is the only router machine in the market to offer 0-9500 true variable rpm's in it's class. This makes it perfect for polishing as well as cutting.

Input: 220V/1 PHASE  
 Output: 2HP/3 Phase  
 No Load Rev Speed: 0-9500rpms with TRUE Variable Speed Control  
 Max. Stone Thickness: 60mm  
 Diamond Grinding Wheel External Diameter Under: 100mm  
 Weight: 48lbs

FREE Ground Shipping on ALL Amigo Routers.



Amigo M4S Stone Router.....\$2,500.00

## Amigo M5 Stone Router



Amigo M5 Heavy-Duty Edge Profiler Machine is our most powerful router machine. It takes 1 PHASE 220V power input and produces continuous 3 horsepower 3 PHASE heavy duty output. 3 PHASE, 3 horsepower output produces smooth torque from initial startup to higher revs and lasts longer with extreme abuse than any other 1 PHASE motor in the market.

Amigo M5 is the only router machine on the market to offer 0-9000 true variable rpm's in it's class. This makes it perfect for polishing as well as cutting.

Amigo M5's revolutionary HYDROFLOAT base is extremely easy to operate. The machine glides on water with a simple touch without even touching the stone. No need to cover up the stone before use or no replacing rollers!

Amigo M5 has the industry's lightest converter box in it's class, and it's top mounted handle makes carrying it very easy from one job to another. Easily screw out knobs at the top gives the user easy access to internals.

Input: 220V/1 PHASE  
 Output: 3HP/3 Phase  
 No Load Rev Speed:0-9000rpms with TRUE Variable Speed Control  
 Max. Stone Thickness: 60mm  
 Diamond Grinding Wheel External Diameter Under 100mm  
 Weight: 77lbs

FREE Ground Shipping on ALL Amigo Routers.

6 month warranty included

Amigo M5 Stone Edge Profiler.....\$3,760.00

## Red Ripper Stone Router



The Red Ripper Router is a unique machine. It has the only non-slip belt drive system on the market. It features a hydrofloat base. This is and all inclusive unit (no boxes, pumps, or converters needed).

Technical Specifications:

- 10,000 RPM Spindle Speed
- TEFC Lincoln Induction Motor
- Unique NWS Belt System
- Soft Rubber Non-Contact Hydroplane Base
- Quick Water Disconnect
- Standard 7/8" Router Bits
- All Connections Mounted Vertical
- NEW - Easy-Adjust Locking Spindle!
- Only 65 Pounds in Weight!
- Full manufacturer's warranty.

2hp/110V.....\$3,019.00  
 3hp/220V.....\$3,292.00  
 3hp/220V Variable Speed.....\$4,069.00



# Largest Online Fabrication Tool Store...

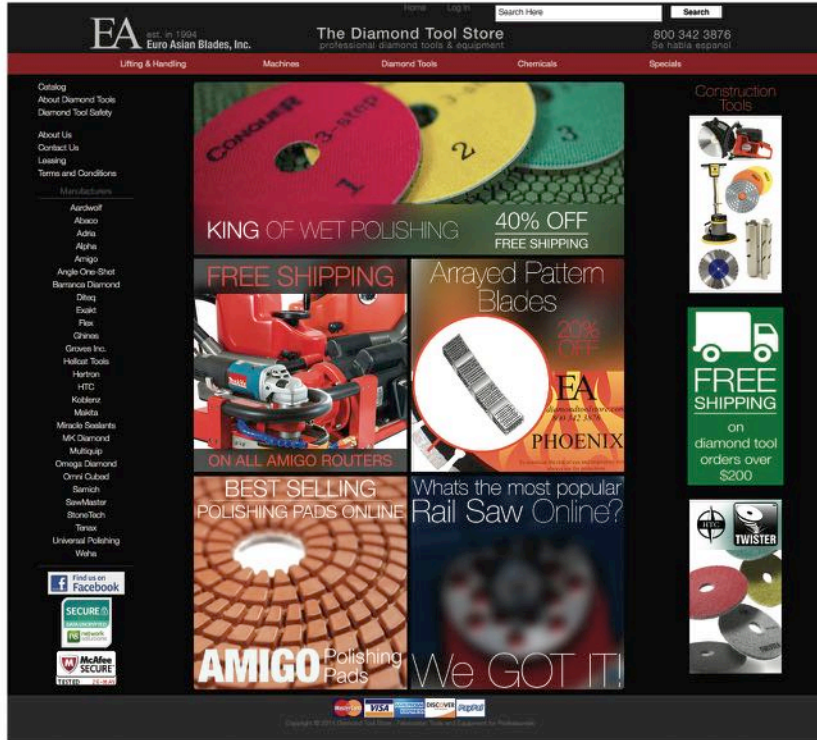

- Special Online Pricing
- Fast Processing
- Quick Delivery
- Special Package Deals

[www.DiamondToolStore.com](http://www.DiamondToolStore.com)

## Amigo Q1 Curve Cutting Machine



The Q-1 Sink Cut Out Machine was developed to fill the need for a reasonably priced machine to easily and accurately cut out the holes for sinks in countertops. Whether it is an offset sink, a regular sink, or a custom designed sink, the Q-1 Sink Cut Out Machine will make your work easy.

The Q-1 Sink Machine can do the job of other machines that cost thousands more. Designed by Professionals for Professionals.

Voltage: 110V  
 Power: 2000W  
 No Load Rev Speed: 12000 rpm  
 Max Wheel Thickness: 40mm  
 Weight: 45lbs

Amigo Q1 Curve Cutting Machine.....\$2,310.00

[www.diamondtoolstore.com](http://www.diamondtoolstore.com)



## Red Ripper Jr. Edging Router for Sink Edging

Built for profiling sinks and edges. Perfect for pre-fabricated natural and engineered stone. Patent Pending. Again we were searching... Searching for a router that was small, light weight and strong. It needed to have an adjustable, coolant through spindle for working sinks, it needed to float lightly on a protective barrier of water, and an adjustable speed motor for getting from high grinding speed to nice and slow polishing speeds. Again we could not find one on the market that stood up to our strong sense of duty to provide the best tools and service to our customers. And so we went ahead and built the Red Ripper Jr. with as much, or more, industrial strength and reliability as our other offerings to the stone industry.

Red Ripper Jr. Edging Router for Sink Edging .....\$2,195.00

110v 12Amp Makita Motor, 2,800-10,500 Motor RPM  
 2,400-8,800 Spindle RPM, Fits Standard 7/8 Bore Bits  
 One Hand Water Disconnect, Easy-Adjust Locking Height Adjustment  
 Only 18 Pounds in Weight!, Full manufacturer's warranty.

Includes These:  
 10 Feet of Water Line

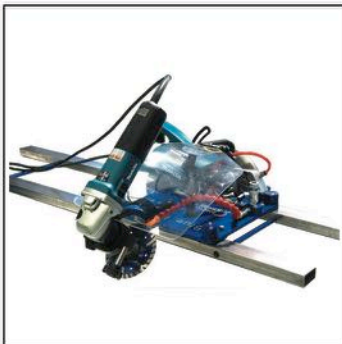

## Omega Eagle Edger Jr

Bevel, shape, flat grind & polish linear edges with the Eagle Edger Jr™ attachment for the Blue Ripper Jr™ Rail Saw. Many of our customers have asked "Can the Blue Ripper Jr cut 45's?" Now it can: With the Eagle Edger Jr™ attachment. This innovative tool gives any owner of a Blue Ripper Jr™ the opportunity to have a mini linear edge machine. Indicator marks are scribed at both 45 angles, and at 0 degrees. (0 degrees meaning the spindle is perpendicular to the surface of the stone.)

Capable of any angle between 46 degrees forward, and 46 degrees back, you can cut a perfect beveled edge, or even a bevel-miter lamination edge!

Omega Eagle Edger Jr .....\$944.00

Cuts 45° angles on top or bottom, Up to ±46° standard, and 90 to 91° with included extension  
 Standard 7/8 inch mount fits most router bits, Mounts onto the Blue Ripper Jr™ Rail Saw  
 Designed to use a Makita 9564CV or 9565CV, right-angle grinder, Light and easy to use  
 Options: Grinder motor pre-installed

Included Items:

Eagle Edger Arm, Eagle Edger Nose & Spindle, Eagle Edger 90° Extension, Flush-Cut Blade Adapter,  
 Flush-Cut Blade, Snail-Lock Adapter, Water Shield, Replacement Water Manifold for Blue Ripper Jr



Made with Pride in the USA

## PitBull BigDog Hydraulic Stone Chiseler

Portable hydraulic stone chiseler, works on almost any stone type - including engineered stone! Capable of up to 3½ inch (8cm) thick laminated stone!

The PitBull BigDog™ Hydraulic Stone Chiseler has a five+ ton rated hydraulic piston providing more than enough power to shear through the hardest of stones. We have tested it on several types of engineered stone, volcanic stone, granite, even marble!

With the PitBull BigDog™ Hydraulic Stone Chiseler's 3 inch wide teeth you can create a perfect edge by overlapping the bites, or you can turn the machine at an angle and create a ragged "mountainous" look. To help create those perfect straight edges, you can clamp a section of angle aluminum on the slab (perhaps with our powerful suction clamps,) and use the guide pins to keep the PitBull BigDog™ Stone Chiseler in perfect alignment for every bite.

PitBull BigDog Hydraulic Stone Chiseler .....\$3,144.00

Up to 5 TONS of pressure, Full range of 0.4 inch (0.9 cm) to 3.3 inch (8.5 cm) stone thicknesses, including laminated and man-made stone

Hand held, Inexpensive mining-grade carbide teeth, Quick-change jaws, 3 inches wide for faster job completion  
 Breaks all stone types, Weighs only 18 pounds

Manufactured with PRIDE in the USA!





## Exakt Saw 330

The New Generation Exakt Saw EC330 is the result of years of fine tuning the original model. The new model is orange in color while the original is green. The pictures shown are the original model in action and represent the tools abilities. The EC 320 features a profiled body shape for easier handling, a more comfortable switching system and a comfort grip. Depth of cut is 12mm / .47 inch.

NOTE: This is the NEW model Exakt Saw, don't confuse it with the older green colored Exakt Saw.

Exakt Saw 330 .....\$139.95



## Exakt Saw DC280

The DC280 Deep Cut Plunge Saw is the "Big Brother" to the EC330. It's not as agile but it makes up for it in power and ease of use. The saw can be operated with one or two hands and the plunge guard makes it super safe to operate. The depth of cut is set in millimeter increments allowing the operator to "just cut through" the material, great for working off a stack of sheet goods.

Exakt Saw DC280 .....\$199.95



## Makita Hand Saw 4200H

- \* High power to weight ratio for fast cutting in a variety of materials
- \* Ball & needle bearing construction for smooth operation & long tool life
- \* Well balanced and light for easy handling
- \* Safety lock-off button to reduce accidental starting
- \* Double insulated. INCLUDES:
- \* Carbide blade (A-90093), Rip fence (164095-8)
- \* Socket wrench (782209-3), Spanner wrench (781011-1).
- \* Full manufacturer's warranty.

Makita Hand Saw 4200H .....\$194.00

\* Blade diameter 4-3/8", \* Arbor 20 mm Max. cutting capacities, \* At 90 degrees 1-1/4" (32 mm), \* At 45 degrees 3/4" (21 mm), \* No Load speed 11,000 rpm, \* AMPS (115 v) 7.8, \* Overall length 9" (230 mm), \* Net weight 6.6 lbs. (3.0 kg), \* Shipping weight 7.4 lbs. (3.4 kg)



## Alpha® AWS-110

The AWS-110 Wet Stone Cutter is ideal for those working with natural and engineered stone, tile, concrete, masonry and glass. It was designed to produce straight and true cuts as required by professional fabricators and installers. Equipped with one of the most powerful motors in its class, the AWS-110 has the strength to power through hard dense materials, such as, porcelain, hard red granites and engineered stone. The water-feed supply eliminates the harmful dust particles common in dry cutting applications. The included self-stick felt strips can be applied to the base plate to protect the work surface from scratches.

Alpha® AWS-110 .....\$128.00

- Equipment Included:
- Ground Fault Circuit Interrupter
  - Water Valve and Hose • Faucet/Garden Hose Adapter
  - Wrench • Straight Cutting Guide (reversible)
  - Extra Carbon Brush Set • Self-Stick Felt strips



## Alpha AWS-125

The AWS-125 Wet Stone Cutter is designed for use in the stone, tile and glass industry. This machine is able to provide perfect straight cuts which is required for quality fabrication and installation. Equipped with one of the most powerful motors in its class, the AWS-125 has the strength to power through tough materials, including porcelain and engineered stones. When used with the proper blade, this wet stone cutter is also equipped with a high quality water-feed system that eliminates the harmful dust particles which are common in dry cutting applications. Another safety feature included is a built-in GFCI (ground fault circuit interrupter).

Alpha AWS-125 .....193.09

- Equipment Included:
- Ground Fault Circuit Interrupter
  - Water Valve and Hose • Faucet/Garden Hose Adapter
  - Wrench • Straight Cutting Guide (reversible)
  - Extra Carbon Brush Set • Self -Stick Felt Strips

## MK Diamond Saws series



MK-1280 Brick Saw



Hand-Held Saw



MK-2007K Masonry Saw

Precision, Ergonomic design and Heavy-duty

We carry the whole line of MK Diamond Saws including Masonry Saw, Brick Saw, Brick & Block Saw, Wet Block Saw, Tile Saw and Tile & Stone Saw.

Check our web site for more information.

MK-1080 10"  
Wet Cutting Masonry Saw

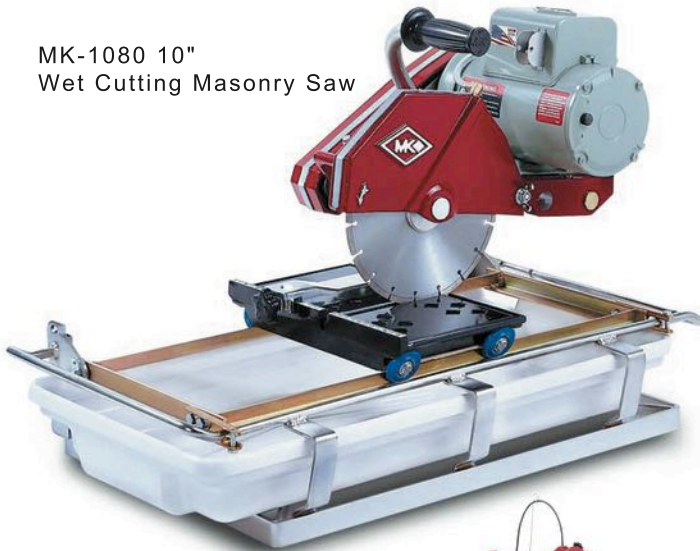

MK-2001SV Brick &amp; Block Saw



MK-100 Tile Saw



MK-212 Wet Stone Saw



# Omega Diamond, Inc.

Omega Diamond, Inc.



Made in the USA  
with USA and foreign parts/materials



[omegadiamond.com](http://omegadiamond.com)



The Blue Ripper Sr. Rail Saw

The Red Ripper Sr. Stone Router

The Blue Ripper Mitler Master Rail Saw

The PitBull BigDog Stone Shear

The Red Ripper Ultralight Stone Router

The Blue Ripper Jr. Rail Saw



## Blue Ripper Rail Saw



Fastest portable rail saw on the market today! Do you want the speed, the accuracy, and the quality of work of multi-thousand dollar bridge saws at a FRACTION of their cost. The Blue Ripper rail saw delivers that and much more. This saw can cut through 2cm of Absolute Black at the amazing speed speed of 10ft. per MINUTE! Full manufacturer's warranty.

- 14 inch blade
- 8 inch flange.
- Standard 3/4 inch quick disconnect water fittings with 10ft of hose!
- Cuts next to rail, needs no gags, no shims or off set measurements!

2 Horse Power-110V-NO RAILS.....	\$3,805.00
3 Horse Power-220V-NO RAILS.....	\$3,805.70
5 Horse Power-230V-NO RAILS.....	\$3,978.70
13ft rail.....	\$595.00
7ft rail.....	\$322.00
4ft rail.....	\$184.00

## Blue Ripper Jr. Rail Saw



Want a powerful, lighter weight Rail Saw? HERE IT IS! Takes full plunge cuts! The Blue Ripper Jr. Rail Saw delivers the speed, accuracy and quality work at your jobsite. It makes full plunge cuts up to 4cm in depth. By using the rail system there is no need to use gages, shims or offset measurements. Full manufacturer's warranty.

Makita, Milwaukee, Skil, or Bosch motors to choose from.

- 8 1/4" Worm Drive Saw
- 120v 13 amp 4300RPM Type 2Motor
- 8" Blade

With blade (no rails).....	\$1505.70
With rails and blade: 7ft and 13ft.....	\$2195.00
13ft rail.....	\$595.00
7ft rail.....	\$322.00
4ft rail.....	\$184.00





## SawMaster Saws

SawMaster offers a complete line of saws to suit the needs of professionals and consumers in the tile, stone, and masonry industries. Unique, innovative ideas and patented technologies make our products stand out above the competition, providing you with the tools you need to get the job done quickly, effectively, and flawlessly. Our saws are manufactured at exacting specifications and undergo a stringent QA process to ensure that they perform optimally at the high standards we set for them, so that they are able to deliver the smooth, precision cuts demanded of any professional saw. Our engineers are among the best and are currently working on next generation saws, many of which you can expect to see in the near future.



SawMaster SDT-1037 Stone Saw

SawMaster SDT-1030 Tile Saw



SawMaster SDT-1025 Stone Saw



SawMaster SDT-35XL Stone Saw



Barranca BD-2014 Tile Saw

## Barranca Diamond Saw Series

Powerful, smooth, accurate and Heavy-duty

We carry the whole line of Barranca Diamond Saws including Tile Saw, Tile & Stone Saw and Wet Cutting Rail Saw.

Check our web site for more information.



Barranca BD-1272 Wet Cutting Rail Saw



Barranca BD-3624 Tile &amp; Stone Saw



BD-1813 Tile Saw





## Husqvarna K 760 Saw

The Husqvarna K 760 is a powerful all-round power cutter with features that make it one of the best power cutters on the market. Equipped with the new generation Active Air Filtration™, one of the market's most efficient centrifugal air cleaning systems that delivers up to one year's operation without a filter change and SmartCarb™, a built-in automatic filter compensation and a highly efficient vibration dampening system. The K 760 is outfitted with an X-Torq® engine that reduces emissions up to 75% and lowers fuel consumption by 20%. Other important features include DuraStarter™, a dust-sealed starter that boosts reliability and product life, Air Purge and a decompression valve with makes the power cutter easy to start. The K 760 is ideal for cutting concrete and stone in alterations, renovations and new construction. It is also perfect for cutting smaller holes and adjusting window and door openings, as well as some pipe, asphalt and metal cutting.

Call for price



## Stihl TS 420 Saw

The TS 420 STIHL Cutquik® cut-off machine — one of the best we've ever built. Helping you work longer and more comfortably, this cut-off machine comes with a 14" wheel, delivering a unique blend of performance and efficiency so you get the job done right. With the revolutionary X2 air filtration system, an anti-vibration system and lightweight design, you get low maintenance and more maneuverability. Its advanced engine technology also increases fuel efficiency and reduces emissions.

Call for price



## Multiquip HS62A Saw

Multiquip's Side Winder high-speed cut-off saws are versatile tools that are ideal for numerous cutting applications. This model combines user friendly features, lightweight design and power-on-demand performance.

Multiquip HS62A Saw .....\$1,105.00

With so many benefits, this saw is a clear choice for the professional and do-it-yourselfer.



## Multiquip HS81A Saw

Multiquip's Side Winder high-speed cut-off saws are versatile tools that are ideal to tackle numerous cutting applications including most masonry and concrete materials. The HS81A's benefits of power-on-demand performance, and ergonomic comfort make it the popular choice for construction professionals and demanding cutting contractors.

Multiquip HS81A Saw .....\$1,300.00



## Abaco Tile Saw

This Abaco Tile Saw TS-1 has a cast aluminum machined working table guided by dual linear bearings on an induction hardened chrome bar (Rust Free).

Accurate cuts time and time again. Cutting range from 90°- 45°.

The TS-1 is now available with wheels for ease of transportation.

Abaco Tile Saw .....\$2,210.44

Blade Capacity 10, Arbor Size 1  
 Depth of Cut at 90° 2  
 Depth of Cut at 45° 1.2  
 Length of Cut 24  
 Working Table 31 x 22  
 Saw Dimensions L x W x H 39 3/8 x 27 9/16 x 48  
 Crated Dimensions 44 x 28 x 26  
 Water Tray 36 x 22 x 6, Water Tray Capacity 18G



## Abaco Site Saw Mod S1

The powerful Abaco Site Saw Mod S1 features a 3Hp motor and is guided by dual linear bearings on induction hardened chrome bar (Rust Free).

The cast aluminum machined working table for accurate cutting of all types of natural and artificial stone. Suitable for construction site and work shops. Incorporated in the Mod S1 are wheels and rollers for effortless single-handed transportation.

Abaco Site Saw Mod S1 .....\$3,319.06

Blade Capacity 10 x 12 x 14, Arbor Size 1  
 Depth of Cut at 90° 2 x 3 x 4, Length of Cut 47  
 Cutting Table 48 x 19  
 Saw Weight Uncrated 275lbs  
 Saw Weight Crated 350lbs  
 Crated Dimensions LxWxH 63 x 29 x 39  
 Saw Dimensions LxWxH 59 x 19 x 51  
 Water Tray 55 x 19 x 6, Water Tray Capacity 24G



## Abaco Site Saw S2

The powerful Abaco Site Saw MOD-S2 features a 3HP motor and is guided by dual linear bearing on induction hardened chrome bars.

The cast aluminum, machined working table is for accurate cutting of all types of natural and artificial stone. The S2 Saw is suitable for construction sites and workshops. Incorporated in the S2 Saw are wheels and rollers for effortless, single-handed maneuvering. This Saw has an electric, direct drive, submersible water pump. This saw ships with a Euro Type 2 wall plug that needs to be replaced by NEMA L6 20 Amp plug available at any hardware store

Abaco Site Saw S2 .....\$3,995.23

Dimension: 82 1/4 x 82 5/8 x 55  
 Cut Depth @ 90°: 2,3,4  
 Cut Depth @ 45°: 1,2,3  
 Cut Length: 61



## Abaco Dehydrator DEH100

The Abaco Dehydrator is a dehydration system for the fast collection and trapping of the abrasive mud produced by machining and finishing marble, granite and other stones. The Abaco dehydrator is an economical, one step method in separating and dewatering sludge's and slurries. The dehydrator is constructed of stainless steel and consists of four basic components: pump, mud holding tank, clean water tray and filter bags. The Abaco dehydrator has no moving parts, requires minimal labor, and is very economical to use. And since it is constructed out of stainless steel, it requires extremely low maintenance.

Abaco Dehydrator DEH100 .....\$4,525.00

Dimension (mm) 2270 x 2220 x 600  
 Weight (kg) 280  
 Power 230v 60Hz / 240v 50Hz  
 Weekly Output Capacity of Dry Mud 22 cu. Feet

Included: 4 Plastic Curtains, 2 Stainless Steel Curtain Rod, 1 5m length Industry water Hose, 3 Industry Hose Clamps, 20 Polypropylene Bags, 1 Pit Cleaning Tool / Air Stick, 1 Solid Rubber Drain Plug





## HTC EZ BB Series

New Super Resin tools with extended life. These new Super Resin tools are a further development of the SR Series (Super Resin). The tools are made from a completely new formula and include other innovations which will make a huge difference for the grinding capacity. The main benefit of these tools is the extended life. They also leave a more uniform scratch pattern compared to other tools which speeds up the grinding process. The tools are available in two versions, SB (Small Block) and BB (Big Block).

BB 3 Grey - 30 grit .....	\$44.00
BB 4 Brown - 60 grit .....	\$44.00
BB 5 Black - 100 grit .....	\$44.00
BB 6 Blue - 200 grit .....	\$44.00
BB 7 Red - 400 grit .....	\$44.00
BB 8 White - 800 grit .....	\$44.00



## HTC EZ C Series

**Soft floors:**  
Floors of loose or porous material. A high rate of removal is achieved with these floors, but with higher tool wear.  
**Medium-hard floors:**  
Normal building concrete. This includes marble and terrazzo floors.  
**Hard floors:**  
Usually refers to steel trowelled floors or certain types of cement. This includes granite. The floors usually require "soft" segments.

C 2 Gold - 25 grit .....	\$79.00
C 3 Grey - 40 grit .....	\$79.00
C 4 Brown - 80 grit .....	\$79.00
C 5 Black - 150 grit .....	\$79.00



## HTC EZ CA Series

The new, improved CA Series. Faster in the beginning and lasts longer in the long run!

The CA Series is a complete line of floor grinding tools for use on normal to soft concrete, natural stone and terrazzo. The course segments in the CA series are ideal for removing a variety of floor coatings such as epoxy paints, adhesives, self-leveling compounds and more...

EZ CA DS 0 Purple - 6 grit .....	\$51.00
EZ CA SS 0 Purple - 6 grit .....	\$30.00
EZ CA DS 1 Silver - 16 grit .....	\$51.00
EZ CA SS 1 Silver - 16 grit .....	\$30.00
EZ CA DS 2 Gold - 25 grit .....	\$51.00
EZ CA SS 2 Gold - 25 grit .....	\$30.00
EZ CA DS 3 Grey - 40 grit .....	\$51.00
EZ CA SS 3 Grey - 40 grit .....	\$30.00
EZ CA DS 4 Brown - 80 grit .....	\$51.00
EZ CA SS 4 Brown - 80 grit .....	\$30.00
EZ CA DS 5 Black - 150 grit .....	\$51.00
EZ CA SS 5 Black - 150 grit .....	\$30.00
EZ CA DS 6 Blue - 300 grit .....	\$51.00
EZ CA SS 6 Blue - 300 grit .....	\$30.00



## HTC EZ FP Series

Resin-bond diamond tools for floor polishing  
HTC's resin-bond diamond tools are many times used after the use of metal-bond diamond tools for floor polishing. However, in some cases a resin-bond diamond tool can be used as a starting tool on smooth flat floors.

FP 10 Black - 100 grit .....	\$8.00
FP 20 Blue - 200 grit .....	\$8.00
FP 30 Red - 400 grit .....	\$8.00
FP 40 White - 800 grit .....	\$8.00
FP 50 Yellow - 1500 grit .....	\$8.00
FP 60 Green - 3000 grit .....	\$8.00



## HTC EZ MR Series

The MR series diamonds are being phased out and being replaced by the SR and FP series. While we may have some of the MR's, quantities are extremely limited.

4 BROWN #80 GRIT .....	\$12.00
5 BLACK #100 GRIT .....	\$12.00
6 BLUE #200 GRIT .....	\$12.00



## HTC EZ SF Series

The EZ SF tools are recommended when grinding a HTC Superfloor™.

The SF Series comes both as double segments and single segments. Below you find the double segments.

SF 0 DS Purple - 6 grit .....	\$51.00
SF 0 SS Purple - 6 grit .....	\$30.00
SF 1 DS Silver - 16 grit .....	\$51.00
SF 1 SS Silver - 16 grit .....	\$30.00
SF 2 DS Gold - 25 grit .....	\$51.00
SF 2 SS Gold - 25 grit .....	\$30.00
SF 3 DS Grey - 40 grit .....	\$51.00
SF 3 SS Grey - 40 grit .....	\$30.00
SF 4 DS Brown - 80 grit .....	\$51.00
SF 4 SS Brown - 80 grit .....	\$30.00
SF 5 DS Black - 150 grit .....	\$51.00
SF 5 SS Black - 150 grit .....	\$30.00
SF 6 DS Blue - 300 grit .....	\$51.00
SF 6 SS Blue - 300 grit .....	\$30.00



## HTC EZ SR Series

HTC extends the MR-series with a step for more coarse grinding.

HTC extends the new generation of resin tools with a step for more coarse grinding which have throughout across-the-board improvements. Better cutting capacity and longer life increase the efficiency and financial flow. The MR tools replace the first steps in the SR Series (Super Resin)

30 RED #400 GRIT .....	\$12.50
40 WHITE #800 GRIT .....	\$12.50
50 YELLOW #1500 GRIT .....	\$12.50



## HTC EZ Grind Series

The tool for everything from coarse grinding to polishing HTC's completely new tools for grinding of natural stone, terrazzo and concrete. Suitable for edge grinding and preparation of surfaces difficult to reach. Can be used for both dry and wet grinding.

The ultimate edge tool from heavy surface removal to polishing, Can be used for both dry and wet grinding, Long life & outstanding performance

EZgrind™ 5" Black - 100 grit .....	\$45.95
EZgrind™ 5" Blue - 200 grit .....	\$45.95
EZgrind™ 5" Brown - 60 grit .....	\$45.95
EZgrind™ 5" Green - 3000 grit .....	\$45.95
EZgrind™ 5" Grey - 40 grit .....	\$45.95
EZgrind™ 5" Red - 400 grit .....	\$45.95
EZgrind™ 5" White - 800 grit .....	\$45.95
EZgrind™ 5" Yellow - 1500 grit .....	\$45.95



## HTC SX Series

HTC extends the MR-series with a step for more coarse grinding.

HTC extends the new generation of resin tools with a step for more coarse grinding which have throughout across-the-board improvements. Better cutting capacity and longer life increase the efficiency and financial flow. The MR tools replace the first steps in the SR Series (Super Resin)

EZ SX 2 .....	\$39.00
EZ SX 3 .....	\$39.00
EZ SX 4 .....	\$39.00



## HTC T-Rex Series

T-Rex™ is intended for removal of coatings, not for conventional grinding! The tools have an extremely high removal capacity and can remove even the thickest coatings such as paint, lacquer, epoxy, acrylic, and residues of adhesive and screed.

### T-Rex™ Gold

This model does not allow you to adjust the grinding pressure, but you get more uniform removal if the surface is very uneven.

### T-Rex™ EZchange™ Gold

The EZchange™ variant of T-Rex™ gives greater freedom of choice when choosing the required removal rate and grinding pressure with either the full set or half set fitted.

T-Rex™ Ezchange™ Gold .....	\$129.00
T-Rex™ Gold Ring (420) .....	\$369.00
T-Rex™ Gold A Ring (650/500) .....	\$459.00
T-Rex™ Gold A Ring (950/800) .....	\$599.00
T-Rex™ Gold A Ring with C1 Protection Segment (950/800)	\$745.00
T-Rex™ Gold B Ring (650/500) .....	\$459.00
T-Rex™ Gold B Ring (950/800) .....	\$599.00
T-Rex™ Gold B Ring with C1 Protection Segment (950/800) .....	\$745.00



## HTC Floor Polishing Machines

HTC 800 HDX Floor Grinder



HTC 950 RX - Three phase / 460 v

The complete range of diamond floor grinders. Perfect for the large area, Patented well-known drive system.

We carry the whole line of HTC Floor Polishing Machines including Industrial Floor Grinder, Floor Grinders and Dust Extractors.

Check our web site for more information.



HTC 500 Floor Grinder



HTC 10 iAD Dust Extractor



**HTC GREYLINE™ 400**



HTC 2500 iX Industrial Floor Grinder

## The Green Polishing Machine



The Green Polishing Machine.....\$6,900.00

The "LIL" Green Polishing Machine - Model# 36-LGPM5HP

This is the most versatile machine, ideal for commercial and residential use. High-performance/ergonomic design gives this smaller machine the advantages of many larger, high cost machines.



The ideal grinding/polishing machine for the beginner or experienced professional on concrete, natural stone and terrazzo surfaces.

### Uses:

Concrete: Preparation of concrete, leveling uneven surfaces, removal of coatings, clean glues and mastics, polishing.

Natural Stone: Clean and/or removal of grease, dirt or scuff marks and light scratches.

Grind and/or polish.

Terrazzo: Clean and/or removal of grease, dirt or scuff marks and slight scratches.

Grind and/or polish.

- String 5hp, 220v, single phase, 16amp motor
- Planetary grinding heads with variable speed control
- 19" polishing width provides almost 3 sq ft of polishing surface
- 0-800rpm drum revolution
- 0-2200rpm revolution
- Dual. 1-1/4" diameter exhaust ports
- 375lbs. with hydraulic pressure control gives ideal polishing/grinding control to a lighter weight machine.
- Wet or dry polishing, 4.75 gallon interpreted liquid delivery system
- 3 Planetary heads for up to 9 pads
- Dual dust extraction ports
- 19" width, 38" height
- Completely gear-driven, no belts to tighten or break





## MK Floor Grinders

Smoother finish, Wide ergonomic design and Power.

We carry the whole line of MK Floor Grinders including Double Disk Grinders and various Floor Grinders.

Check our web site for more information.



MK-DDG-11 Double Disk Grinder

MK-DDG-13 Double Disk Grinder



MK-SDG-7 Grinder



MK Sawtec 7" Grinder



MK-SDG-3 Floor Grinder



### Diamond Construction Blade

These durable blades offer top performance, long life and excellent value for masonry, bricks, pavers, block, cured concrete, green concrete, and asphalt.

Made in Korea

12".....	\$132.00
14".....	\$159.00
16".....	\$195.00
18".....	\$246.00

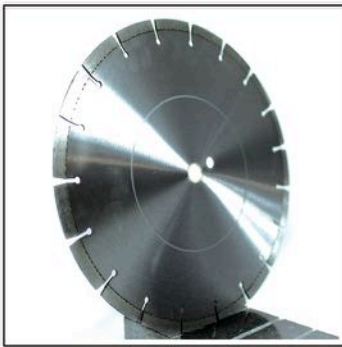

### GS Concrete Blade - Segmented

This blade is laser welded and to be used with water or without water. With 12mm segment height, durability is better than other blades in this category. This blade is made for harder materials, such as block, concrete, hard concrete, pavers, and brick.

Made in Korea

Please contact us for more sizes and options.

4".....	\$19.59
4.5".....	\$29.04
5".....	\$33.15
7".....	\$39.24
12"x.125x1"-20mm, 12mm rim.....	\$149.00
14"x.125x1"-20mm, 12mm rim.....	\$169.00

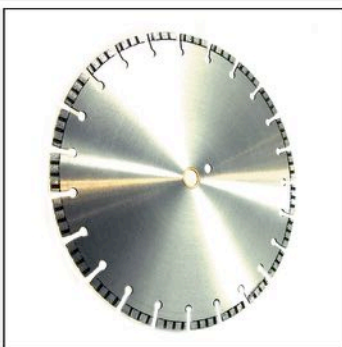

### Turbo Segmented Diamond Blade

New design cuts fast through the hard stone. This blade is laser welded for safety with a diamond height of 10mm. Use wet or dry to cut granite, concrete, and marble.  
1"-20mm Arbor.

Made in Korea

10".....	\$98.00
12".....	\$132.00
14".....	\$158.00



## MK Construction Blades



MK-7710W Pro Blade.....Starting at: \$538.31  
 MK 7501 Concrete Blade.....Starting at: \$576.58  
 MK CX-10 Cured Concrete Blade.....Starting at: \$147.58  
 (More models are available on our website)

We carry the whole line of MK Construction Blades.

The MK-Pro Series is designed and engineered for use on high horsepower, flat saws. This Professional Series is for contractors who insist on optimal performance. All Pro Series blades are available in a variety of bond hardnesses to assure maximum performance no matter what your job.

## Multiquip Construction Saws



Multiquip MP3 Masonry Saw.....\$1,080.00  
 Multiquip SP118 Concrete Saw.....\$2,807.25  
 (More models are available on our website)

We carry the whole line of Multiquip Construction Saws.

The Multiquip offers a powerful motor, portability, and accurate sawing performance. Ergonomically designed, it excels in cutting a wide variety of materials including bricks, blocks, interlocking pavers, stone, terra cotta, and roofing tile. A great investment for the Professional Mason, General Contractor, and DIY operator.

MK-2013HE Self-Propelled Concrete Saw



MK-4036HY Gas Concrete Saw

## MK Construction Saws

MK Diamond Products is a recognized world leader in the manufacturing of precision diamond blades and equipment for cutting, coring and polishing all types of masonry, concrete, tile and stone products.

We carry the whole line of MK Construction Saws. For more information, please visit our website.

MK-4030KB Diesel Concrete Saw



MK-2013HE Self-Propelled Concrete Saw



MK-3030V Self-Propelled Concrete Saw







## Hertron VitreGel

This series of products is used for removing scratches and traffic patterns from marble and terrazzo when diamond honing is not possible. Vitre Gel is a cost effective process for producing a beautiful polished floor. On an extremely scratched floor, start with VG/80, followed by VG/220, VG/320, VG/500, then VG/POLISH. On a lightly worn floor, start with VG/500 followed by VG/POLISH. On a dull floor, start with VG/POLISH.

An abrasive Liquid Diamond process used on heavily worn surfaces and followed by Vitre Gel 220, 320, 500 and Vitre Gel Polish.

VG/80 .....	Quart:\$40.86/Gallon:\$107.17
VG/220 .....	Quart:\$40.86/Gallon:\$107.17
VG/320 .....	Quart:\$40.86/Gallon:\$107.17
VG/500 .....	Quart:\$40.86/Gallon:\$107.17
VG/Polish .....	Quart:\$40.86/Gallon:\$107.17
VG/Enhancer .....	Quart:\$40.86/Gallon:\$107.17

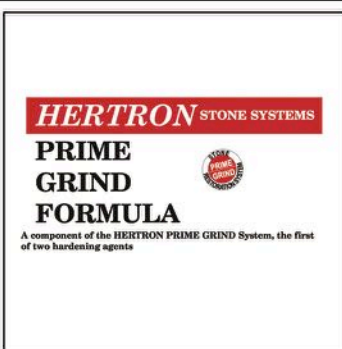

## Hertron Prime Grind

The Prime Grind System is a premium marble and terrazzo restoration system that focuses on leveling, deep cutting and grinding techniques to restore a wide range of stone surfaces. Designed for use by restoration contractors and other specially trained professionals.

1.....	Gallon:\$69.90
2.....	Gallon:\$69.90
A.....	Gallon:\$60.40
M.....	Gallon:\$69.90



## Hertron Marble Supreme

Marble Supreme Polishing Compound with Hardening Agents

### Details/Specifications

- Ready mixed polishing paste for polishing marble, travertine, limestone, and terrazzo, that has been diamond cut to 400 or 800 grit.
- Can be used to restore worn marble , travertine, limestone, or terrazzo, and also helps to provide initial water/stain resistance.
- Easy to use. Requires very simple instructions to produce beautifully polished stone with great depth.
- Produces a deeper, clearer polish, 15 to 20 percent faster than competitive products tested.

10lb.....	\$162.00
25".....	\$420.00



## Mira Polish

MiraPolish is a unique, natural, non-wax crème compound for the polishing and restoration of most marble, travertine, limestone, terrazzo, granite and other calcium base natural stone surfaces. When used properly, MiraPolish™ will give a long lasting luster, while removing scratches and etch marks. MiraPolish™ is great for easy ongoing maintenance, as well as the final polishing step in any stone restoration procedure. Heavy scratches and etch marks may need to be removed using Miracle Sealants' Pre-Dust, Mira Hone or with Pyramid Diamond Abrasives.

4.5lbs .....\$51.75  
 10lbs .....\$88.92



## Miracle 511 Concrete Surface Treatment

"CST" Concrete Surface Treatment is a unique polymerized formulation designed for the protection of all concrete products. "CST" forms an invisible barrier that is resistant to moisture and stains while allowing vapor to escape. Concrete surfaces are protected from spalling and damage by salt water intrusion in addition to excellent Freeze-Thaw performance.

1 Quart .....\$36.75



## Miracle 511 Grout Sealer

Grout Sealer is a sealer designed for the protection of all sanded and non-sanded grout joints. Grout Sealer forms an invisible barrier that is resistant to moisture and stains while allowing vapor to escape. Grout Sealer is not a surface coating and will not alter the natural look. Grout Sealer comes with a unique Applicator Tip for easy application.

Miracle 511 Grout Sealer .....\$4.87



## Miracle 511 H2O Plus

511 H2O is a water base penetrating sealer designed for the protection of all surfaces. 511 H2O is not a surface coating and will not alter the natural look. 511 H2O is VOC compliant and does not produce a strong odor. 511 H2O does not contain P.F.O.S. or P.F.O.A.

1 Gallon .....\$94.50

INDEPENDENT TESTS SHOW 511 H2O OUT PERFORMS COMPETITIVE PRODUCTS. (Test results are available upon request).



## Miracle 511 Impregnator

511 Impregnator is the original penetrating sealer designed for the protection of all medium to dense porous surfaces. 511 Impregnator forms an invisible barrier that is resistant to moisture and stains while allowing vapor to escape. 511 Impregnator is not a surface coating and will not alter the natural look. All surfaces treated are harder and less slippery. INDEPENDENT LABORATORY TESTS SHOW 511 IMPREGNATOR OUTPERFORMS COMPETITIVE PRODUCTS.

1 Quart .....\$25.90  
 Contractor Pack .....\$84.00





## Miracle 511 Marble Conditioner

Marble Conditioner is a recrystallization treatment designed to maintain the polish of marble, terrazzo and agglomerate surfaces.

1 Gallon .....\$31.00

A floor or hand buffer is necessary for this procedure. We recommend using a Marble Master MM 1000 (150 lbs & 175 rpm) floor machine or hand machine with the appropriate steel wool pads.



## Miracle 511 Tile & Stone Cleaner (Formerly Mira Clean)

A concentrated cleaner designed for all surfaces. Strong enough for the professional, yet gentle enough for the do-it-yourself specialist. Mira Clean #1 is a nontoxic cleaner that can handle the most difficult stains, yet is gentle enough for everyday use

1 Quart Spray .....\$8.40  
1 Gallon .....\$17.50



## Miracle 511 Porous Plus

511 Porous Plus is a penetrating sealer designed for the protection of the most porous surfaces. 511 Porous Plus forms an invisible barrier that is resistant to moisture and stains while allowing vapor to escape. 511 Porous Plus is not a surface coating and will not alter the natural look. All surfaces are harder and less slippery. INDEPENDENT TESTS SHOW 511 POROUS PLUS OUT PERFORMS COMPETITIVE PRODUCTS. (Test results are available upon request).

1 Quart .....\$58.00  
1 Gallon .....\$170.00



## Miracle 511 Residue Remover

Residue Remover is a unique solvent-base formula designed to remove accumulated residue build-up on the surface, due to over applying solvent-base penetrating sealers/impregnators. Residue Remover is also useful for cleaning application tools for re-use.

1 Quart .....\$9.90  
1 Gallon .....\$22.50



## Miracle 511 Seal & Enhance

511 Seal & Enhance is a unique, solvent-base formula designed to eliminate the need to use an impregnator before using a color enhancer for maximum stain protection and superior color enhancement. 511 Seal & Enhance is safe for use on granite, marble, limestone, natural stone, slate, ceramic tile, quarry tile, grout, concrete and masonry surfaces. 511 Seal & Enhance will enhance the color and rejuvenate the appearance of tumbled, honed, acid-washed, sandblasted, flamed, textured, even polished stone and tile surfaces. In addition, 511 Seal & Enhance revitalizes old and worn stone and tile installations. It can be used successfully in both interior and exterior environments and is freeze/thaw resistant.

1 Quart .....\$49.00  
1 Gallon .....\$162.00



### Miracle 511 Stone Polish

Stone Polish nourishes and enriches the natural beauty and polish of marble, granite, agglomerate, terrazzo and stone counter tops, vanities, fireplaces and walls. Stone Polish is not recommended for floors. Stone Polish is easy to use, with no machinery necessary for removal. Not for floors.

- 1 Quart .....\$16.00
- 1 Gallon .....\$57.00



### 511 Kleen & Reseal

511 Kleen & Reseal is a unique formula designed to remove dirt and soil from natural stone and tile, including vanities, showers and furniture and reseals in one easy step. Kleen & Reseal will cut through dirt and soil with no rinsing, no streaking and no soapy residue left behind. 511 Kleen & Reseal is safe for all types of surfaces.

- 511 Kleen & Reseal .....\$11.60



### 511 Spray-On Grout Sealer

Miracle 511 Spray-On Grout Sealer is a new fast & easy way to seal tile grout. This unique spray-on sealer provides an invisible barrier that is resistant to oil, stains and water absorption.

- 511 Spray-On Grout Sealer .....\$9.50



### 511 Counter Clean

Counter Kleen is a unique formula designed to remove dirt, dust and light stains from polished natural stone and ceramic tile counters, vanities and furniture.

Container size: 32 oz. spray bottle.

- 511 Counter Clean .....\$9.50



### Epoxy Grout Film Remover

Epoxy Grout Film Remover is a non-acid cleaner designed for the removal of epoxy grout film from tile, concrete and stone surfaces.

Coverage: 50 - 150 square feet per gallon (4 - 14 square meters per 3.785 liters).

- 1 Quart .....\$20.00
- 1 Gallon .....\$53.95





## Granite Brite

Granite Brite is a no-wax compound designed for the polishing or color enhancement of new and worn granite surfaces, primarily floors. Granite Brite contains only high quality abrasives.

Used as directed, Granite Brite will cover approximately 160 square feet per 1-pound container (15 square meters).

1lbs .....\$17.90



## Grout Color Kit

Grout Color Kit comes complete with a scrub pad and unique Applicator Tip for changing the color of grout. This is an easy, inexpensive way to renew old grout without having to cut out and replace it. Grout color will also seal and protect grout from moisture and stains. Great for counter tops, walls and floors.

Antique White .....\$16.50  
 White .....\$16.50  
 Bright White .....\$16.50  
 Light Gray .....\$16.50  
 Dark Gray .....\$16.50  
 Gray .....\$16.50  
 Sand Beige .....\$16.50  
 Terra Cotta .....\$16.50  
 Rose .....\$16.50



## Grout & Concrete Film Remover

GCFR (Grout & Concrete Film Remover) is a fast acting, heavy duty acid cleaner for textured, unpolished, natural and manufactured surfaces. GCFR removes sanded grout & mortar residue, joint cement, lime & hard water deposits, efflorescence, rust and other heavy dirt and grime.

1 Quart .....\$9.50  
 1 Gallon .....\$20.00



## Finish Sealer Stripper (Formerly H2O Strip)

H2O Strip is a fast acting, high potency stripper designed to remove exaggerated build up of wax finish or acrylic emulsions. H2O Strip is recommended for removing Mira Shine or High Gloss Finish when necessary. H2O Strip is also an effective cleaner for removing some epoxy grout films, heavy soil, dirt, tar, grease and other stains from porous surfaces..

1 Quart .....\$13.00  
 1 Gallon .....\$34.00



## Mira Dust

Mira Dust is a unique, fast acting polishing powder designed to enhance the natural shine of natural stone surfaces. Mira Dust will remove light scratches and acid etch marks in addition to polishing. Mira Dust can be used for the final polish of a restoration process or for use as an easy ongoing maintenance procedure.

1lbs .....\$21.40



### Mira Matte

Mira Matte is a unique product designed to enhance the natural color of all flamed, sandblasted, split faced, tumbled and textured surfaces. When used with one of our penetrating sealers, Mira Matte seals and protects while leaving a beautiful, low maintenance, color enhanced satin sheen. Mira Matte allows vapor to escape while offering a scuff and weather resistant surface. Mira Matte is U.V. transparent, will not yellow and can be used on both interior and exterior applications.

Mira Matte.....\$14.40



### Mira Shine

Mira Shine is formulated for interior use as a high gloss surface sealer. The combination of Mira Shine with the appropriate Miracle Sealants penetrating sealer provides durable protection.

1 Quart.....\$18.60  
1 Gallon.....\$37.50



### Mira Strip

Mira Strip is a fast acting stripper designed to remove traditional solvent base coatings and waxes for preparation of one of our penetrating sealers and/or color enhancing products. Mira Strip is recommended for removing Mira Matte color enhancer when necessary and may be effective as a cleaner for removing some food greases, tar and other hard to remove stains from porous materials.

1 Quart.....\$18.60  
1 Gallon.....\$37.50



### Poulitice Plus Powder

Poulitice Powder is an easy to use, fine, non-acidic absorbent powder designed to work with different cleaners/chemicals to draw out most stains from most absorbent surface materials.

1lbs.....\$7.00



### Porcelain & Ceramic Tile Cleaner

Porcelain & Ceramic Tile Cleaner is a unique penetrating scouring compound that quickly and easily removes stubborn stains, grease, soap scum, heel and scuff marks, dirt and everyday grime. Porcelain & Ceramic Tile Cleaner can be used by hand or with a floor machine and will also clean grout very well. Porcelain & Ceramic Tile Cleaner will also remove hard water deposits and soap scum on stone showers.

1 Quart.....\$9.50  
1 Gallon.....\$20.00





## Water Ring & Etch Remover

Water Ring & Etch Remove is a unique, fast acting polishing powder specially formulated to remove water rings, light scratches and etch marks.

Water Ring & Etch Remover .....\$11.00



## Miracle Haze b Gone

Miracle Sealant pleased to introduce a new revolutionary product, Haze b Gone. A safe, environmentally friendly and easy-to-use method for removing grout haze. No more acids or other dangerous and time consuming methods. Never has grout haze removal been so easy.

\$12.95

PROTECT

Protect your natural stone,  
tile and masonry

CLEAN

Formulated specifically for cleaning  
stone, tile and masonry

TRANSFORM

Restores luster and enhances stone's natural beauty

**DuPont™ StoneTech® Professional**  
 THE SCIENCE BEHIND KEEPING STONE, TILE AND MASONRY BEAUTIFUL

1-877-786-6383 [www.stonetechpro.com](http://www.stonetechpro.com)

Copyright © 2014 DuPont. The DuPont Oval Logo, DuPont™, The miracles of science™, and StoneTech® are registered trademarks or trademarks of E.I. du Pont de Nemours and Company or its affiliates. All rights reserved.



### StoneTech Stone Sealer

- Advanced penetrating microbond protection
- Standard protection against all stains
- Makes cleaning stone easier
- Preserves natural look
- Water-based low-solids coating
- Interior & exterior

**Where to Use**

Natural stone such as marble, granite, limestone, slate, terrazzo, travertine & sandstone.

1 Quart.....	\$15.84
1 Gallon.....	\$47.61



### StoneTech Bulletproof Stone Sealer

- Advanced penetrating microbond protection
- Maximum protection against all stains
- Makes cleaning stone easier
- Preserves natural look
- Water-based low-solids coating
- Interior & exterior

**Where to Use**

Natural stone such as marble, granite, limestone, slate, terrazzo, travertine & sandstone.

1 Quart.....	\$34.00
1 Gallon.....	\$112.00



### StoneTech Heavy Duty Stone Sealer

- Advanced penetrating microbond protection
- Heavy duty protection against all stains
- Makes cleaning stone easier
- Preserves natural look
- Water-based low-solids coating
- Interior & exterior

**Where to Use**

Natural stone such as marble, granite, limestone, slate, terrazzo, travertine & sandstone.

1 Quart.....	\$23.79
1 Gallon.....	\$71.55



### StoneTech Heavy Duty Exterior Sealer - Solvent Based

- Heavy duty protection against water-based stains
- Natural look
- Solvent-based, exterior use

**Where to Use**

Natural stone such as limestone, granite, slate, flagstone, sandstone & bluestone. Masonry & concrete.

1 Gallon.....	\$50.00
5 Gallon.....	\$220.00



### StoneTech Grout Sealer

- Heavy duty protection against all stains
- Protects grout & makes cleaning easier
- Natural look
- Water-based low-solids coating
- Interior & exterior

**Where to Use**

Grout for ceramic & porcelain tile.

1 Quart.....	\$11.97
--------------	---------





## StoneTech Grout Release & Water Repellent

- Makes grout clean-up easy
- Reduces grout staining
- Water-based low-solids coating
- Interior & exterior

1 Gallon .....\$19.36

### Where to Use

Natural stone such as marble, limestone, travertine, slate, sandstone & tumbled stone. Masonry & concrete.



## StoneTech Impregnator Pro Sealer

- Heavy duty protection against all stains
- Original fluorochemical technology
- Natural look
- Solvent-based, interior & exterior

1 Quart .....\$26.00

1 Gallon .....\$102.00

### Where to Use

Natural stone such as marble, granite, limestone, slate, terrazzo, travertine & sandstone. Best suited for the most porous stone surfaces.



## StoneTech Revitalizer Cleaner & Protector

- Mold & mildew resistant protector
- Cleans everyday messes while reinforcing protection
- Built-in sealer makes surfaces easier to clean
- Neutral, gentle formula
- Great for stone countertops and everywhere else

Spray.....\$8.48

Wipes.....\$8.48



## StoneTech Stone & Tile Cleaner

- Cleans everyday messes
- Neutral, gentle formula
- Great for stone & ceramic tile floors

1 Quart .....\$8.50

### Where to Use

Natural stone such as marble, granite, limestone, travertine, slate, terrazzo & sandstone. Ceramic tile, porcelain tile & grout.



## StoneTech Klenz All

- Powers through stubborn grease & soils
- Safe on stone, will not etch
- Professional strength, alkaline formula

1 Quart.....\$8.48

### Where to Use

Natural stone such as marble, granite, limestone, travertine, slate, terrazzo & sandstone. Ceramic tile, porcelain tile & grout. Masonry & concrete.



### StoneTech Restore

- Renews tile & grout
- Cleans away hard water deposits, grout haze, efflorescence & soap scum
- Professional strength, acidic formula

1 Quart .....\$8.48

Where to Use  
Ceramic tile, porcelain tile & grout. Masonry & concrete.



### StoneTech Professional Lacquer

- Topical high gloss look & enriches color
- Maximum protection against most stains
- Solvent-based, interior & exterior

1 Gallon .....\$47.69

Where to Use  
Natural stone, masonry & concrete (outdoor patios, walkways, driveways, garage floors, concrete slabs, sidewalks, retaining walls & BBQ areas). Not intended for use on dense, glazed, polished, or non-absorbing surfaces (ceramic tile, porcelain tile), wood floors & decks.

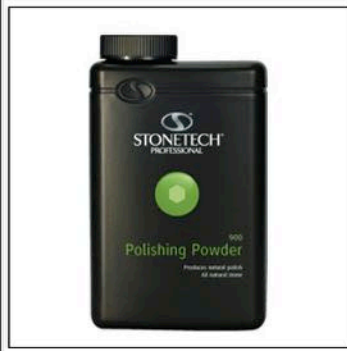

### StoneTech Polishing Powder

- Creates smooth, satin finish
- Eliminates etch marks & light wear patterns
- Non-acidic

1 Quart .....\$31.93

Where to Use  
Natural stone such as marble, limestone, travertine & terrazzo.



### StoneTech Marble Shining Powder

- Creates high shine finish
- Brings back luster of polished stone
- Non-acidic

1 Quart .....\$32.36

Where to Use  
Natural stone such as marble, limestone, travertine & terrazzo.



### StoneTech Enhancer Pro

- Richens color
- Heavy duty protection against all stains
- Solvent-based, interior & exterior

1 Quart .....\$42.00

1 Gallon .....\$139.00

Where to Use  
Natural stone such as marble, limestone, slate, travertine, sandstone, flagstone, tumbled stone, flamed stone & textured stone. Masonry & concrete.





## Adria Bond

Glue for Stone

Use to glue, repair, fill marble, granite, or other stones including engineered stone.

Hardner included

Buff Knife Grade

1 liter.....\$11.00  
4 liter.....\$41.00  
17 liter.....\$145.00

Buff Flowing

1 liter.....\$11.00  
4 liter.....\$41.00  
17 liter.....\$145.00

White Knife Grade

1 liter.....\$11.00  
4 liter.....\$41.00  
17 liter.....\$145.00

White Flowing

1 liter.....\$11.00  
4 liter.....\$41.00  
17 liter.....\$145.00

Transparent Knife Grade

1 liter.....\$11.00  
4 liter.....\$41.00  
17 liter.....\$145.00

Transparent Flowing

1 liter.....\$11.00  
4 liter.....\$41.00  
17 liter.....\$145.00

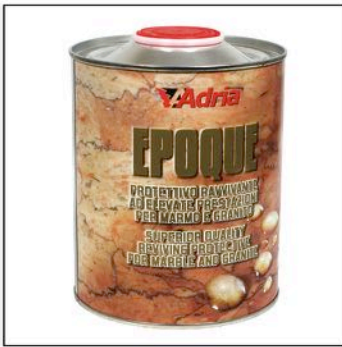

## Adria Epoque

Color enhancer

1 liter.....\$52.00



## Adria Krisspay

Liquid wax

\$17.50



## Adria Plus Black

Enhancer for darker colors

1 liter.....\$45.00



### Tenax Polyester Resin

Mastic to fill and glue marbles and stones.

Hardner Included.

Color: trasparente, white, buff  
Type: flowing, solid

1 Quart.....	\$11.30
1 Gallon.....	\$42.00
4.5 Gallons.....	\$149.00



### Tenax Hardner

Tenax Harder

45ml.....	\$3.00
180ml.....	\$6.00

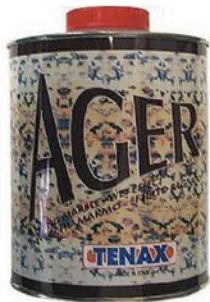

### Tenax Ager Color Enhancer

- Enhances color
- Leaves a permanent wet look on stone surfaces
- 1 Liter covers 160 - 180 square feet
- Drying time is about 60 minutes
- Water-repellent effect within 24 hours from application

Tenax Ager Color Enhancer.....	\$57.00
--------------------------------	---------



### Colors for TENAX Stone Glue

Colors for TENAX Stone Glue

Black.....	\$5.40
White.....	\$5.40
Brown.....	\$5.40
Red.....	\$5.40
Beige.....	\$5.40
Blue.....	\$5.40
Green.....	\$5.40



### Paste Wax

Made in Italy.

Black.....	\$20.00
Transparent.....	\$20.00
Red.....	\$20.00
Green.....	\$20.00
Yellow.....	\$20.00





## Camie 300 General Purpose Spray Adhesive

Camie® 300 general purpose spray adhesive provides instant tack, high strength, temporary and permanent bonds. 14 ounce can.

Camie 300.....\$7.00

Perfect for plain back sand paper use!



## Acetone

Acetone

1 Quart.....\$11.00  
1 Gallon.....\$26.30



## VMC 5X Polishing Powder

This powder is used as a final step in achieving the high reflectivity finish that is seen on polished marble tiles and slabs. Used with water and a buffing pad, one can get excellent results.

VMC 5X Polishing Powder.....\$52.00



## Pre-Stardust Powder 1lb

Use before polishing with Stardust Powder. This powder removes light scratches that cannot be removed by normal polishing. Not for use on granite or green marble.

Pre-Stardust Powder 1lb.....\$23.00



## Star Dust Powder 1lb

This powder removes superficial scratches and etch marks caused by certain acids in fruit juices, spirits, vinegar, etc. For use on marble, limestone, terrazzo, travertine, and onyx. Not for use on green marble or granite.

Star Dust Powder 1lb.....\$23.50



## VMC Natural Stone Sealer

A few benefits of using this silicone free impregnator are water and oil repellency, stain resistance, mildew resistance, and easy application. It can be used on polished, framed, or honed finishes without changing the look of the stone. It is great for granite, marble, limestone, and slate. cures fast (10-15 min.)

VMC Natural Stone Sealer.....\$92.00



## Granite Polishing Powder 1lb

Use on light and dark granite to remove scratches and restore gloss and color.

Granite Polishing Powder 1lb.....\$37.00



## Green Marble Polishing Powder

This polishing powder is formulated for the unique qualities of green marble (serpentine). Use this product to remove superficial scratches and dulling from high traffic areas. It restore gloss and color in a single step. Designed for maintenance use, this polish will not remove deep abrasions or restore badly damaged surfaces without proper honing operation.

Green Marble Polishing Powder.....\$33.00



## VMC V1 Crystallization Polish 1.5 Gal

V-1 vitrification liquid(white)-for use on dark, non-porous marbles such as Negro marquina, grey paloma, emperador, rosso levanto and all greens. It can also be used for high crystalline materials.

VMC V1 Crystallization Polish 1.5 Gal.....\$56.00



## VMC V2 Crystallization Polish 1.5 Gal

V-2 vitification liquid (pink)-general purpose. Recommended for light colored materials, worn areas, and maintenance.

VMC V2 Crystallization Polish 1.5 Gal.....\$63.00





## Rhino Polishing Powder

Rhino Polishing Powder removes fine scratches. Made of the finest ingredients on the market and is proven for its polishing power for light and dark marble. When using this product, you will experience the fastest polishing results on floors, walls, tables and counter-tops. Ideal for Marble Limestone and Onyx. Coverage: 1000-1500 square feet per 5 lbs container.

5 lbs/2.27 kg

Rhino Polishing Powder.....\$37.00



## Rhino Crystallizer

The Rhino Crystallizer gives floors an incredible shine.

Coverage: 2000 sq. ft. per 1 gallon when using first time.  
4000 sq ft. per 1 gallon when used for maintenance.

1 Gallon/ 3.78 Liters.

Rhino Crystallizer.....\$48.00



Professional's Choice



## Stone, Tile, Grout & Masonry Care Products

Miracle Sealants Company is one of the world's leading manufacturers of premium quality, professional grade care products for tile, grout, marble, limestone, natural stone, concrete and masonry surfaces. We have surpassed the industry standard for more than 30 years satisfying thousands of customers in the tile, stone, masonry, design, architectural, janitorial and private label industries. Products include: penetrating sealers, cleaners, color enhancements and grout additives.



12318 Lower Azusa Road, Arcadia, California 91006 • 1-800-350-1901 • [miraclesealants.com](http://miraclesealants.com)

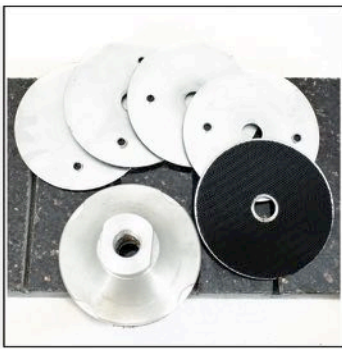

### Magnetic Adhesive Backing Pad Set

3", Holder + 6-Piece Set.....	\$65.00
3", Holder.....	\$31.00
3", 6-Piece Plate Set.....	\$44.00
4", Holder + 6-Piece Set.....	\$73.00
4", Holder.....	\$39.00
4", 6-Piece Plate Set.....	\$52.00

This new backing system for polishing pads are revolutionary! The main holder is magnetic and has the most popular 5/8-11 thread attachment. There are 6 plates that would attach to the hold magnetically. These plates are self-adhesive hook-and-loop.

Having these 6 plates attached to different grits of polishing pads would make your workflow easier and faster! You can switch between pads easily without damaging the actual used polishing pads.



### Backing Pad - 7 inch Spongy

Perfect for those 7 inch polishing pads. Comes with 5/8"-11 thread pattern.

Backing Pad - 7 inch Spongy.....	\$15.00
----------------------------------	---------



### Premium Flexible Backing Pads

Higher quality than our regular backing pads. Unique grooves give it a smoother flex and longer last.

5/8"-11 thread size

3".....	\$14.00
4".....	\$16.00
5".....	\$17.00





### Extra Thick Spongy Backing Pad - 4 Inch

Has 5/8" - 11 thread to be used with most grinders/cutters.

Extra Thick Spongy Backing Pad - 4 Inch.....\$10.00



### Snail Lock Backing Pads

These backer plates are for low speed polishers and Commandulli systems.

Snail Lock Backing Pads.....\$48.00



### Core Connection for 5/8"-11 Thread

Need to use your core bits with your regular power drill? This is the solution!  
Has 5/8" - 11 thread pattern to be used with most regular diamond core bits.

Core Connection for 5/8"-11 Thread.....\$18.00



### Dressing Wheel

Used to dress the grinding stone.

Dressing Wheel.....\$16.30



### 5/8"-11 to 10mm M10 Adapter

You have a 5/8"-11 thread polisher or router and want to use router bits with 10mm? This makes it possible!

5/8"-11 to 10mm M10 Adapter.....\$39.00

Perfect to use on routers such as Amigo MX1250 for 10mm M10 connections.



### Adaptor for Cup Wheels

Threaded connection hubs.

Adaptor for Cup Wheels.....\$18.00



### Flush mount flange Adaptors for Blades

Having one side of the blade flush is very popular for sculptors, stone & finish cutters, using right angle grinders for surface relief cutting, pitching lines, and intricate cutting.

4-Hole.....\$18.00  
8-Hole.....\$69.00

Has 5/8"-11 thread female thread.



### Replacement Bolt for Profile Bits

Replacement Bolt for Profile Bits

10mm.....\$15.00  
8mm.....\$15.00



### Replacement Ball Bearing for Profile Bits

These blades are ideal for cutting hard granite. The close separation allows fast, chip free cutting. Best when used wet!  
Made in Korea

Replacement Ball Bearing for Profile Bits.....\$25.00

available size: 3/4", 1-1/4", 1-1/2"  
available shape: Full Bull Nose, Ogee, Bevel



### Shank Adapter for Profile Bit

Shank Adapter for Profile Bit

Shank Adapter for Profile Bit.....\$25.00





### 5/8"-11 To Sector Adapter

5/8"-11 To Sector Adapter

5/8"-11 To Sector Adapter.....\$59.00



### Omega Q-Jig

The Omega Q-Jig™ (Quirk Miter Jig) allows the easy production of accurate "quirk" miter seams.

Omega Q-Jig.....\$150.00

The Q-Jig™ is designed for extreme versatility in use; you can use it as a simple square, draw a 45 degree line, mark a line perfectly parallel to the edge for your sink cut-out, and many more uses! The removable pins are long enough to allow perfect alignment on a 4cm (1.5 inch) bull-nose!

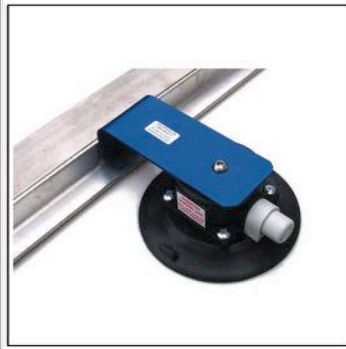

### Blue Ripper Rail Suction Grip Add-on

If you find that you just can't find a spot to clamp the rail down, or that your rails wander while cutting, this is perfect for you!

Blue Ripper Rail Suction Grip Add-on.....\$60.00

Simple to install in just 6 easy steps!



### Sink Setter - For Undermounting Sinks

Easier to Install: With a socket & screwdriver, thanks to our patented system  
 Used by professional sink installers  
 Stronger: Heavy gauge steel leveling bolts, bolt caps & brackets, support any sink  
 Adjustable: No shimming or sawing  
 Removable: Without removing the counter  
 Fast: Installs in minutes – saves money  
 Dependable: Providing trouble-free sink installations for over 10 years.

Sink Setter - For Undermounting Sinks.....\$23.00

Three sizes of sink brackets  
 PW-99 front to Back installations 14" to 26"  
 PW-104 Side to Side installations 25" to 47"

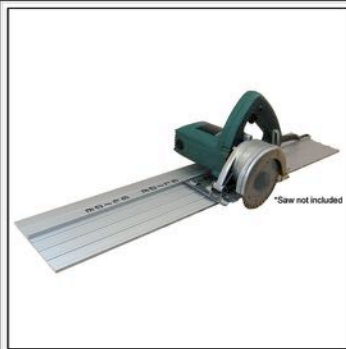

### Glide Guide

The GLIDE-GUIDE elevates the saw above the finished surface. The only moving part that touches your work piece is the blade. **MADE IN THE USA!** (Saw not included)  
 Lightweight for easy transport and alignment.  
 Rubber treads on bottom help prevent slippage.  
 Easily clamp along flange to secure work piece.  
 Works with virtually any circular saw.  
 Quick fixes in the field: No more taping of the stone to prevent scratches or expensive rail saws in the trucks.  
 Truing up to 4CM laminations.  
 Cleaning up seam edges  
 Rodding

Glide Guide 34.....\$55.00  
 Glide Guide 48.....\$75.00  
 Glide Guide 72.....\$125.00  
 Glide Guide 96.....\$160.00



### Backing Pads

Flexible Backing pad : for contours, edges and surfaces

Firm Backing pad : for straight edges and surfaces

5/8"-11 thread pattern

3".....	\$10.00
4".....	\$12.00
5".....	\$15.00

Options: Flexible, Rigid



### MK Diamond Flexible Rubber Back Plate Discs

Hook & Loop backed rubber disc for attaching polishing pads to hand-held polishing tools.

Nut Size: 5/8"-11

3" (76mm).....	\$20.00
4" (102mm).....	\$26.00
5" (127mm).....	\$30.00
7" (178mm).....	\$90.00



### MK Diamond Aluminum Back Plate Discs

Aluminum Hook & Loop backed disc for attaching polishing pads to hand-held polishing tools. Max 4,000 RPM.

Nut Size: 5/8"-11

3" (76mm).....	\$42.00
4" (102mm).....	\$44.00
5" (127mm).....	\$72.00



### Rigid Back Plate Discs

Rigid Hook & Loop backed disc for attaching polishing pads to hand-held polishing tools. Max 4,000 RPM.

Nut Size: 5/8"-11

3" (76mm).....	\$20.00
4" (102mm).....	\$22.00
5" (127mm).....	\$33.00



### MK Diamond Snail Lock Back Plate Discs

Hook & Loop backed disc for attaching polishing pads to Snail Lock clamshell backer.

4" (76mm).....	\$16.00
5" (102mm).....	\$28.00





### Diskit Backer Pads: 5 inch

10000 Maximum RPMs.

5268with M8(IT) adapter, canvas face.....	\$17.90
5272 with M8(IT) adapter, vinyl face.....	\$17.30
5281 with 5/8"-11 adapter, canvas face.....	\$17.30
5282 with 5/8"-11 adapter, vinyl face.....	\$17.30



### Silicon Carbide Sand Paper

Dia-Plus silicone carbide flexible sandpaper is perfect for all your sanding & polishing needs on marble, granite, metal, wood, and other hard surfaces. Adhesive back is easier to use by peeling off the back and sticking on a backer pad. Plain back is used with spray adhesive.

Grit: 60, Backing: Plain.....	\$19.00
Grit: 80, Backing: Plain.....	\$17.00
Grit: 120, Backing: Plain.....	\$16.00
Grit: 220, Backing: Plain.....	\$16.00
Grit: 320, Backing: Plain.....	\$16.00
Grit: 400, Backing: Plain.....	\$16.00
Grit: 500, Backing: Plain.....	\$16.00
Grit: 600, Backing: Plain.....	\$16.00
Grit: 1000, Backing: Plain.....	\$16.00
Grit: 60/80/120/220/320/400/500/600/1000 Set.....	\$18.00



### Grinding Stone Wheels for Granite or Marble

Silicone Carbide. Perfect for natural stone. Has 5/8"-11 thread.

Grit:16, Size: 3".....	\$8.50
Grit:24, Size: 3".....	\$8.50
Grit:36, Size: 3".....	\$8.50
Grit:46, Size: 3".....	\$8.50
Grit:60, Size: 3".....	\$9.50
Grit:80, Size: 3".....	\$9.50
Grit:100, Size: 3".....	\$9.50
Grit:120, Size: 3".....	\$9.50

\*\*for 4", add \$1.00



### Wooden Mixing Sticks

Use to mix and apply your adhesives.

Wooden Mixing Sticks.....	\$8.95
---------------------------	--------



### Heavy Duty Water Proof Apron

Heavy duty apron.

Heavy Duty Water Proof Apron.....	\$12.00
-----------------------------------	---------



### Stonemason Apron

Quick snap straps for fast and easy fit  
 Made of a double layer of the highest quality material for extra protection  
 Velcro strips help quickly access polishing pads

Stonemason Apron.....\$25.00



### Razor Blades

Box of 100

Razor Blades.....\$4.50



### Particle Mask

Box of 50.

Particle Mask.....\$9.95



### Storm PVC Working Boots

PVC Working boots for men. Comes in 9, 10 and 11 sizes.

9.....\$20.00  
 10.....\$20.00  
 11.....\$20.00



### Amfi-USA Steel Wool Hand Pads

Made from the finest quality of raw material. Out perform our competitor's products  
 Competitive price, longer life based on advanced manufacturing technique means overall lower costs for users  
 Available as 16 pads per bag – 15 grams per pad – 12 bags per case  
 Grades #0000 to #4  
 Grade #0000 is produced to the "finest" specifications. Do not believe Steel Wool is graded as #0000 until you have seen our product!

Grit:0.....\$4.20  
 Grit:1.....\$4.20  
 Grit:2.....\$4.20



## SeaRay 175 Floor Polisher Package

SeaRay 175 Floor Polisher Package.....Call for price

1. Pacific SeaRay 175 Floor Buffer
2. Water Tank for SeaRay 175
  - 4 Gallon Capacity
3. Plastic Plate for SeaRay 175
4. Aluminum Plate for SeaRay 175
5. EA Standard Diamond Polishing Pads
  - #50, #100, #200, #400, #800, #1500, #3000 grits
  - 4 sets to include 28 total pads
  - 4 inch diameter with flexible resin



The SeaRay 175 floor machine is an essential component for your floor care programs, designed to meet today's cleaning challenges. Built with durable cast aluminum housings, switch levers and bases, SeaRay's are workhorses you can depend on, year after year. The SeaRay 175 is equipped with a 17" cleaning surface and comes with a 1.5 HP motor and triple planetary gear boxes. This machine features an ergonomically-friendly kick lever for unlimited handle settings as well as the unique molded-in Tote-A-Cap feature for extending the life of pad drivers and brushes

## SeaRay 175HD Floor Polisher Package

SeaRay 175HD Floor Polisher Package.....Call for price

1. Pacific SeaRay 175HD Heavy Duty Floor Machine
2. Water Tank for SeaRay 175HD
3. Plastic Plate for SeaRay 175HD
4. Aluminum Plate SeaRay 175HD
5. Twister Grinding Cup Wheel Set
  - 4 Wheels
  - 4 inch diameter
  - Twisted pattern
6. EA Standard Polishing Pads
  - #50, #100, #200, #400, #800, #1500, #3000 grits
  - 4 sets - 28 pads total
  - 4 inch diameter
  - flexible resin



This SeaRay 175HD Heavy Duty Floor Machine Package is designed with the customer in mind. Affordable, Versatile, and Durable. With the two driver pads, Water tank, and Cup wheels, this package will allow you to do coatings removal, flat grinding, as well as polishing. This package is one of the best floor care values available today.



### Economy Fabrication Package

1. Blue Ripper Jr. Rail Saw
2. Amigo M2 Stone Router
3. Alpha VSP-120 Polisher
4. Makita 9564CV Grinder
5. EA Premium Polishing Pad Set
6. Diamond Brazed Cup Wheel
7. Dia-Plus Maxima Turbo Blade
8. Amigo Full Bullnose Profiling Bit
9. Amigo Ogee Profiling Bit
10. Hook-and-Loop Backing Pad
11. Apron

Economy Fabrication Package.....\$4400.00



### Standard Fabrication Package

1. 3hp Blue Ripper Rail Saw
2. Amigo M4s Stone Router
3. Alpha VSP-120 Polisher
4. Makita 9564CV Grinder
5. EA Premium Polishing Pad Set
6. Diamond Brazed Cup Wheel
7. Dia-Plus Maxima Turbo Blade
8. Dia-Plus Full Bullnose Profiling Bit
9. Dia-Plus Ogee Profiling Bit
10. Hook-and-Loop Backing Pad
11. Apron

Standard Fabrication Package.....\$7200.00



### PREMIUM Fabrication Package

1. 5hp Blue Ripper Rail Saw
2. Amigo M5 Stone Router
3. Alpha VSP-120 Polisher
4. Makita 9564CV Grinder
5. EA Premium Polishing Pad Set
6. Diamond Brazed Cup Wheel
7. Dia-Plus Maxima Turbo Blade
8. Dia-Plus Full Bullnose Profiling Bit
9. Dia-Plus Ogee Profiling Bit
10. Hook-and-Loop Backing Pad
11. Apron

Premium Fabrication Package.....\$8800.00



## Oscillating Package Deal

Perfect for corner polishing for stone countertop fabrication.

Call for price



1. Chicago Electric Oscillating Multi-Function Power Tool
  - 21,000 Oscillations/min
  - Volts:120
  - Amps:1.8
  - Power Cord: 6ft
  - Horsepower: 1/4hp
2. Triangular Hook-and-Loop Backing Pad
3. Triangular Dry Polishing Pads
  - #50, #100, #200, #400, #800, #1500, #3000
  - 7 Pads total

## Conquer Special with Teq-Shine Polisher

Conquer Special with Teq-Shine Polisher Package combines our best selling, new, state-of-the-art polishing pads with Diteq Teq-Shine Water Polisher. These new Conquer pads eliminates need for traditional 7-step pad setup and do the whole job with just 3 pads while cutting the time in half. This Diteq Teq-Shine water polisher is our substitute for our best selling hand polisher, Hellcat WPV-100. This machine is very similar with even lower pricing.

Call for price



1. TEQ-SHINE Wet Polisher
  - 650W/6amps
  - 5/8"-11 Spindle
2. Conquer 3-Step Diamond Polishing Pads
  - 1, 2, 3 Steps included (3 pads)
  - 4 inch in diameter
  - Flexible resin with hook-and-look adhesive backing
3. 4" Premium Hook and Loop backer Pad

## EA Pad Special with Teq-Shine Polisher

EA Pad Special with Teq-Shine Polisher Package combines our economical, yet high quality polishing pads with Diteq Teq-Shine Water Polisher. These EA diamond polishing pads are great for any granite, marble or even concrete fabrication job. This Diteq Teq-Shine water polisher is our substitute for our best selling hand polisher, Hellcat WPV-100. This machine is very similar with even lower pricing.

Call for price



1. TEQ-SHINE Wet Polisher
  - Variable Speed 800-3600rpm
  - 650W/6amps
  - 5/8"-11 Spindle
2. EA Diamond Polishing Pads
  - #50, 100, 200, 400, 800, 1500, 3000 included
  - 4 inch in diameter
  - Flexible resin with hook-and-look adhesive backing
  - Great for granite, marble, travertine, or other stones or even concrete!
- 4" premium Hook and Loop Backer

## Amigo S-9 Air Polisher With EA Pad Set

1. Amigo S9 Water Air Polisher
  - Air pressure : 6~7kg/cm2 (8cfm at 90psi)
  - Speed : 4,500 rpm
  - Grinding Wheel : 3-1/8"
  - Spindle : 5/8 - 11 thread
  - 3 months limited warranty included

Call for price



2. EA Premium Polishing Pads
  - #50,#100,#200,#400,#800,#1500,#3000 included
  - 4 inch in diameter
  - Flexible with self-adhesive back
  - Perfect for granite or marble
  - Wet application
3. Self-Adhesive Backing Pad
  - Flexible
  - 4 inch in diameter
  - 5/8-11 thread spindle

## Amigo S9 Air Polisher with Amigo Pad Set

1. Amigo S9 Air Sander/Polisher
  - Air pressure : 6~7kg/cm2 (8cfm at 90psi)
  - Speed : 0 - 4,500 rpm
  - Grinding Wheel : 3-1/8"
  - Spindle : 5/8 - 11 thread
  - 3 months limited warranty included
  - With 4" Hook and Loop Backer Pad

Call for price



2. Polishing Pads - 3 Options
  - Amigo Polishing Pads (Default Option)
    - 4 inch flexible
    - Grits: #50, #100, #200, #400, #800, #1500, #3000
  - Dia-Plus Premium Polishing Pads (2nd Option)
    - Premium quality
    - 4 inch flexible
    - Grits: #50, #100, #200, #400, #800, #1500, #3000
  - Conquer 3-Step Polishing Pads (3rd Option)
    - Premium quality with new technology
    - 4 inch flexible
    - Grits: coarse, medium, fine

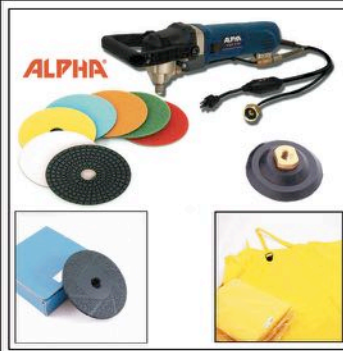

## Wet Polishing Package 1

1. Alpha® VSP-120 Variable Electric Polisher
2. EA Premium Diamond Polishing Pads
3. Diamond Brazed Flat Cup Wheel
4. Hook-and-Loop Backing Pad
5. Apron

Call for price



## Wet Polishing Package 2

1. Alpha® VSP-120 Variable Electric Polisher
2. Premium Concrete Diamond Polishing Pads
3. Diamond Brazed Flat Cup Wheel
4. Hook-and-Loop Backing Pad
5. Apron

Call for price

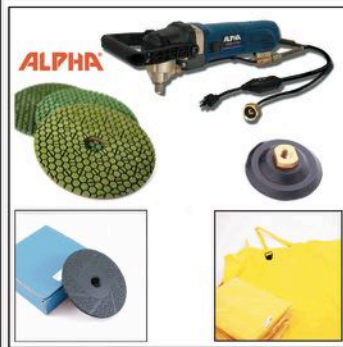

## Wet Polishing Package 3

1. Alpha® VSP-120 Variable Electric Polisher
2. Conquer 3-Step Polishing Pads
3. Diamond Brazed Flat Cup Wheel
4. Hook-and-Loop Backing Pad
5. Apron

Call for price



## EA Wet Polishing Package

1. Alpha® VSP-120 Variable Electric Polisher
  - Rating: 110/220 Volts
  - Amperage: 7.8/3.9
  - Power: 800 watts
  - Speed :500~2800 RPM
  - Spindle : 5/8 - 11 thread
  - Weight: 6.96lbs/3.15 kg
2. EA Standard Diamond Polishing Pads
  - #50, #100, #200, #400, #800, #1500, #3000
  - 4 inch in diameter
  - Flexible with self-adhesive back
  - Perfect for granite or marble
  - Wet application

Call for price



## EA Dry Polishing Package

1. Makita 5 inch Angle Grinder 9565CV
  - Power: 12amps
  - Rotation: 2,800-10,500
  - Diameter: 5inch
  - Spindle: 5/8-11 thread
2. EA Dry Diamond Polishing Pads
  - #50, #100, #200, #400, #800, #1500, #3000
  - 4 inch in diameter
  - Flexible with self-adhesive back
3. Brazed Flat Grinding Wheel
  - 5 inch diameter
  - Perfect for granite or marble
  - 5/8-11 thread attachment
4. Self-Adhesive Backing Pad
  - Flexible
  - 4 inch in diameter
  - 5/8-11 thread spindle

Call for price





## EA Standard Diamond Pad Set

Grits:  
#50, #100, #200, #400, #800, #1500, #3000

Call for price

These flexible diamond pads are the best value for money! Comes in 4 inch and can be used on granite, marble, concrete, or any other stone with water.



## Sink Polishing Package Deal

1. Amigo MX1250 Mini Router w/Makita 9564CV
2. Brazed Diamond Drum Wheels
3. Oscillating Head
4. Oscillating Polishing Drum Wheels

Call for price



## Alpha Scratch Removal kit

Designed with stone fabricators in mind, this kit comes with everything you need for scratch removal and seam polishing in the field. Start with the How-To Video to learn the proper scratch removal technique, then utilize the Alpha® Twistouch Turbo system to polish the flat surface without the wavy finish caused by most flexible polishing discs. The AWP-158 comes with a "C" handle and a flat polishing caster designed to improve stability during scratch removal and seam polishing for superior results. Expand your client base and offer this value added post-installation service by using the Alpha® Scratch Removal Kit!

Alpha Scratch Removal kit.....Cal for price

Includes:

- AWP-158
- TU30100R, TU30200R, TU30500R, TU31000R,
- TU32000R, TU33000R,
- TUBLACKTW25/8AL
- AVWPRON
- DVD-170004



# Delivery Service

Available  
Upon Request

800-342-3876

Special Financing Available

**APPLY TODAY**

[www.diamondtoolstore.com](http://www.diamondtoolstore.com)

800-342-3876



# EA

**Euro Asian Blades, Inc.**

1335 Old Okeechobee Rd - STE 100  
West Palm Beach, FL 33401, USA

Toll Free: 800-342-3876  
Local: 561-833-8992  
Fax: 561-833-9092

Email: [euroasia@diamondtoolstore.com](mailto:euroasia@diamondtoolstore.com)

[www.diamondtoolstore.com](http://www.diamondtoolstore.com)

From:

Euro Asian Blades, Inc.  
1335 Old Okeechobee Rd.  
Suite #100  
West Palm Beach, FL 33401

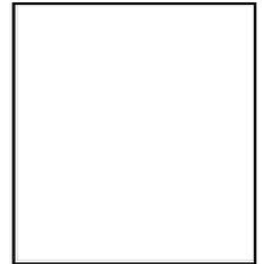

EA 800 342 3876 www.diamondtooblstore.com 2014/2015