

# Pro'sKit®

Professional Tool Solutions Since 1991

## TOTAL TOOL SOLUTION

INNOVATION · QUALITY · SERVICE

## CATALOG 14

Testers · Precision pliers & cutters  
Electrical pliers & cutters  
Knives, scissors & saws  
Crimpers · Strippers · Punchdown tools  
Soldering/Assembly · Screwdrivers/Bits  
Hex key/Wrenches · Socket wrenches  
Esd static protection · Tweezers  
Magnification & lighting · Power tools  
Fiber optics · Miscellaneous  
Instrument cases · Lan/Datacomm · Connectors  
Wiring installation · Tool cases · Tool kits



# 2014 New Arrival !

**Pro'sKit®**

Professional Tool Solutions Since 1991

In this year, Pro'sKit developed a series of networking cable testers and distance measurer, and fiber optical category to provide different test solutions and also complete the product categories. **Check it now!!**

## FIBER OPTICS TESTER/CUTTER/STRIPPER



### Fiber Tester

- Easy testing ST type
- Fast display

3PK-NT018S-ST P.134

### Fiber Cleaver

- Precision cutting
- Long service life

FB-1688C P.135

### Stripper

For FTTH cable with steel wire

CP-FB01 P.135

## LASER DISTANCE MEASURERS

- Water Proof
- Dust Proof



40M  
NT-6540 P.22

IP54  
ECCEN 6029

60M  
NT-6560 P.22

70M  
NT-6570 P.23

IP67  
ECCEN 6029

80M  
NT-6580 P.23

IP54  
ECCEN 6029

## DIGITAL METERS



MT-1233C P.18

MT-1233D P.18

MT-1217 P.16

AUTO  
Range

CAT II  
600V

CAT III  
1000V

## AC True RMS METERS



MT-1705 P.15

MT-1710 P.14

AUTO  
Range

CAT III  
600V

CAT IV  
600V

## CABLE TESTERS



For RJ45/RJ11

MT-7025 P.9

For RJ45/RJ11/  
BNC/USB/IEEE1394

MT-7059 P.9

For HDMI

MT-7062 P.10

Large  
LCD

## FLASH LIGHT /GLUE GUN / MULTI TOOLS



9 LEDs  
Bright!

FL-516 P.125

Cordless!!  
Power by Batteries

GK-368 P.83

9 in 1  
Good Quality

MS-525 P.139

## SCREWDRIVERS



Apple  
Repair  
Kit

- P2, P5, P6  
Pentalobe  
bits

- 30 pcs Aluminum Handle  
Precision Screwdriver Set

SD-9608 P.92

- Consumer Electronic  
Equipment Repair Kit

SD-9326M P.90

## VARIABLE SPEED ROTARY TOOL KIT

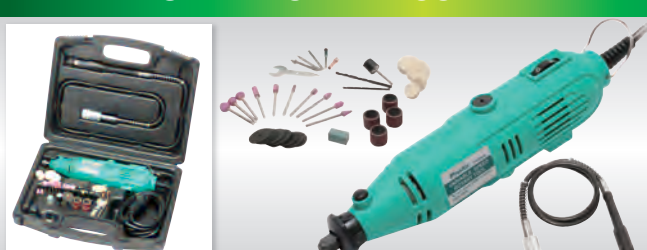

- Powerful variable speed from 10,000 to 32,000RPM
- 40pcs multipurpose accessories
- Carrying case included

PT-5501A P.131

# INNOVATION • QUALITY • SERVICE

**Pro'sKit®** is an international brand of total solution provider for tools and tool kits in electronic, electrical, computer, networking & telecom fields in the worldwide market. **Pro'sKit®** has been developing its product lines and expanding its business with the policy of innovation, quality and service.

Quality is the foundation of **Pro'sKit®** brands. As an ISO9001:2008 certified manufacturer since 1998, all **Pro'sKit®** products meet or exceed quality standards and quality control procedures conform to the strict requirements of the standards. There is nothing that cannot be further improved. **Pro'sKit®** always adheres to its quality policy & high standard and will continue to enhance the capability.

Most of **Pro'sKit®** electronic power products are qualified by CE or GS, TUV and **Pro'sKit®** has been devoted to conforming to RoHS since 2006 per the European Union's regulation that secure **Pro'sKit®** high product quality for our customers throughout the world.



Computerized SOP Production Line



Handheld XRF for RoHS Compliance Testing



Lifetime Testing Machine

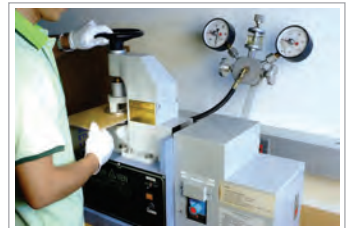

Burst Strength Tester



Reliability Test



Salt Spray Test



Torque Testing Machine



High Compliance Multi-Product Calibrator



# Pro'sKit® Symbols

	Wire spring		RS232 D-sub round barrel contact pins or sockets		TRI-wing		Duty Cycle
	Leaf spring		Insulated & non-insulated wire ferrules		Ball hex		Relative reference
	Flat		Hex type coaxial & fiber optic connectors		Star		Continuity buzzer
	Half-round		Oval type coaxial & fiber optic connectors		Square tamper proof		Continuity check
	Round		Square type coaxial connectors center contact pins		Torx® plus 5 star		Diode test
	Stripping flat telephone cables		Crimping pressure adjustment		Torx® plus socket		Transistor hFE test
	Stripping twisted pair round cables		Ratcheting release knob		Pentalobe star tip		LED test
	2 blade stripping coaxial cables		Ratcheting release trigger		Square drive socket		Battery check
	3 blade stripping coaxial cables		Force-saving design		Bi-hexagon socket		Inductor check
	Mini bevel		Ratcheting force-saving design		Needle type bits		Backlight
	Full flush		Black tip		ESD safe		Maximum/Minimum value
	Extra full flush		Slotted		Non-magnetic		Maximum value hold
	Cross Cut		Phillips		Magnetic		Data hold
	Serrated		Torx®		Safety caution		Auto power off
	Smooth		Torx® tamper proof		Insulated		Low battery
	Crosswise serrated		Hex		1KV insulated protection		Zero-ohm adjuster
	4 pin(RJ22) telephone handset plugs		Hex tamper proof		RoHS directive		Output terminal
	6 pin(RJ11/RJ12) telephone plugs		Nut		Lead free		RS232C connector
	8 pin(RJ45) modular plugs		Pozidriv		Complied with IEC/EN 60529 IP54 test		USB connector
	10 pin(RJ50) modular plugs		Triangle		DC voltage		Hygrometer
	Telecom splice connectors		Spanner nut		AC voltage		Thermometer
	Pin terminal, insulated & non-insulated ferrules		Spanner		DC current		Light meter
	Insulated & non-insulated wire ferrules		Torq		AC current		Sound level meter
	Non-insulated terminals & lugs		Wing nut driver		Resistance		Class2, double insulated
	Open barrel, non-insulated terminals & lugs		Phillips tamper proof		Frequency		A type AC110V~120V
	D-Sub terminal & Non-Insulated Open Barrel Connectors		Clutch		Capacitance		E type AC110~120V
	Insulated terminals, Insulated & Uninsulated Flag		Spline		Temperature °C/F measurement		
	Insulated terminals		Square		Temperature °C measurement		

Torx® is a registered trademark of Camcar Textron

All rights reserved. Reproduction in whole or in part in any language without permission is prohibited.  
 Printed in Taiwan, March, 2014. First Edition  
 ©2014 ProKit's Industries Co., LTD.

# CONTENTS

	<b>TESTERS</b> <b>Page. 4-25</b>
--	-------------------------------------

	<b>TWEEZERS</b> <b>Page. 114-117</b>
--	---

	<b>PRECISION PLIERS &amp; CUTTERS</b> <b>Page. 26-37</b>
---	---

	<b>MAGNIFICATION &amp; LIGHTING</b> <b>Page. 118-125</b>
---	---

	<b>ELECTRICAL PLIERS &amp; CUTTERS</b> <b>Page. 38-46</b>
---	--

	<b>POWER TOOLS</b> <b>Page. 126-131</b>
---	--

	<b>KNIVES, SCISSORS &amp; SAWS</b> <b>Page. 47-50</b>
---	--

	<b>FIBER OPTICS</b> <b>Page. 132-137</b>
---	---

	<b>CRIMPERS</b> <b>Page. 51-65</b>
---	---------------------------------------

	<b>MISCELLANEOUS</b> <b>Page. 138-146</b>
---	--

	<b>STRIPPERS</b> <b>Page. 66-73</b>
--	--

	<b>INSTRUMENT CASES</b> <b>Page. 147-152</b>
--	---

	<b>PUNCHDOWN TOOLS</b> <b>Page. 74-76</b>
---	--

	<b>LAN/DATACOMM</b> <b>Page. 153-165</b>
---	---

	<b>SOLDERING / ASSEMBLY</b> <b>Page. 77-84</b>
---	---

	<b>CONNECTORS</b> <b>Page. 166-167</b>
---	---

	<b>SCREWDRIVERS / BITS</b> <b>Page. 86-104</b>
---	---

	<b>WIRING INSTALLATION</b> <b>Page. 168-171</b>
---	--

	<b>HEX KEY / WRENCHES</b> <b>Page. 105-107</b>
---	---

	<b>TOOL CASES</b> <b>Page. 172-179</b>
---	---

	<b>SOCKET WRENCHES</b> <b>Page. 108-110</b>
---	--

	<b>TOOL KITS</b> <b>Page. 180-203</b>
---	--

	<b>ESD STATIC PROTECTION</b> <b>Page. 111-113</b>
---	--

	<b>INDEX</b> <b>Page. 203-208</b>
---	--------------------------------------



# TEST INSTRUMENTS

# MT-8100 Butt Set



## Features:

- High impedance monitor
- Line voltage test
- Line Continuity test
- Polarity indication
- Two-way hands-free speakerphone
- Tone and pause operation
- Speed dialing
- Last number redial
- PBX pause button
- Mute switch
- Electronic adjustable Volume
- Auto power off
- Low battery indication
- Audible ring
- Extra large steel locking belt clip
- Angled bed of nails and RJ11 plug



Waterproof



Dustproof

- Drop Protection
- Rugged
- Exterior
- Voltage Test

IEC/EN 60529  
**IP54**

Mark for products that comply with IEC/EN 60529  
IP54 Dustproof & Waterproof tests

Electrical	
Loop limit	2 KΩ maximum at 48 VDC (nominal 20 mA minimum loop current)
DC resistance	
Talk mode	300Ω typical
Monitor impedance	39kΩ nominal at 1 kHz
Rotary dial output	
Pulsing rate	10pps±0.8pps
Percent break	61%±2%
Interdigit interval	1000 ms typical
Leakage during Break	>50 kΩ
DTMF output	
Tone frequency error	±1.2% maximum
Tone level	-8±2dBm combined (typical)
High versus low tone difference	4 dB maximum
Memory dialing	
Memory capacity	13 memories including M1, last number redialing
Digit capacity	16 digits per memory
PBX pause duration	4 seconds
Line voltage test	5 Phase AC/DC voltage indication (under 24V, 24~100V, 101~150V, 151~200V, more than 200V)
Monitor amplifier	9V transistor; provides 25 hours continuous use, typical
Power source	Continuous use, typical
Automatic power shut off(Monitor type)	After 5 min. of no audio signal
Speaker phone levels	Electronically adjustable
Fuse	250V, 250mA
Power source	Battery (9V) 6F22 (Not included)
Physical	
Measurement	230 × 82 × 89mm (9.1" × 3.2" × 3.5")
Weight	635g typical
Water resistance	Dust protection & Waterproof tested to an IEC/EN 60529 IP54 rating
Cord sets	Angled bed of nails and RJ11 plug
Environmental	
Temperature	Operating: 0 to 50°C Storage: -10 to 60°C
Altitude	To 10,000 feet (3,000M) max
Relative humidity	5 To 95%

Individual packing: Color box



## 400-042 Butt Set



Rests easily on shoulder



Polarity LED indications



### Features:

- Recognized as the new industry standard, the 400-042 butt set provides superior quality at an affordable price.
- With its high impedance monitor for data safe operation, technicians can clip onto a line in Monitor mode without disrupting existing traffic.
- **Proskit**® unsurpassed protection standards and durability assure the butt set will keep working even in the toughest environments.
- New weatherproofing provides enhanced resistance to severe weather conditions.



Large multi-functional panel



Angled bed of Nails



Durable hanger



Electrical	
Loop limit	2 kΩ maximum at 48 VDC (nominal 20 mA minimum loop current)
DC resistance	
Talk mode	300Ω typical
Monitor impedance	39kΩ nominal at 1 kHz
Rotary dial output	
Pulsing rate	10pps±0.8pps
Percent break	61%±2%
Interdigit interval	1000 ms typical
Leakage during break	>50 kΩ
DTMF output	
Tone frequency error	±1.2% maximum
Tone level	-8±2dBm combined(typical)
High versus low tone difference	4 dB maximum
Memory dialing	
Memory capacity	12 memories plus last number redialing
Digit capacity	16 digits per memory
PBX pause duration	4 seconds
Monitor amplifier power source	9V transistor; provides 25 hours continuous use, typical
Speaker levels	Low, medium, high
Automatic power shut off	After 5 min. of no audio signal
Speaker phone levels	Low, medium high
Fuse	250V, 250mA
Power source	Shared line and battery power
Physical	
Length	10.2"(26.0 cm)
Width	2.8"(7.0 cm)
Height	3.5"(8.90 cm)
Weight	560 g typical
Environmental	
Temperature	Operating: 0 to 50° C Storage: -40 to 66° C
Altitude relative humidity	To 10,000 feet 5 to 95%

Individual packing: Color box

## 900-244 In-Line Modular Adapters (4/6/8 Pin 3 In 1)

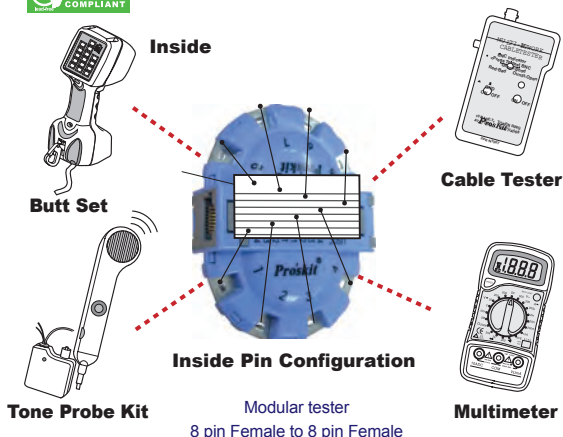

### Features:

- The 900-244, In-line Modular Adapter allows in-line testing for any plug/jack combination. It includes two 4-pair jacks plus a modular cord terminated with 4-pair "universal" plug for accessing any standard 6- or 8-position jack.
- Individual conductors are broken out by pin number and correspond to eight separate test pads.
- Test equipment can be securely attached to the test pads using alligator clips.
- For quick reference in the field, USOC, T568A, and T568B wiring charts are printed right onto the body.



	6 pin Female to 8 pin Male		8 pin to 8 pin 205mm
	4 pin Female to 8 pin Male		8 pin to 6 pin 205mm
			8 pin to 4 pin 205mm

Individual packing: Blister card



## MT-8006B Data Diver



### Features:

- LCD display for dialing number, Caller ID, Clock and other information
- Indicator for determining the line service
- Smart power saving enables battery life up to 6 months
- 12 phone number memory for speed dialing
- 16 dialing number memories
- Tone (DTMF) and pulse operation
- Up to 32 digits phone number memory for speed dialing key
- Pre-dialing and last number redial function
- PBX pause key, insert a PBX pause in stored numbers
- Telephone line polarity indicators
- Low battery indication
- Backlight function
- RJ-11 port for easy test leads change
- Ringer and voltage LED indication
- Angled bed of nails and RJ-11 plug

Electrical	
Loop limit	2 K $\Omega$ maximum at 48 Vdc (nominal 20 mA minimum loop current)
DC resistance	
Talk mode	300 $\Omega$ typical
Monitor impedance	>39k $\Omega$ nominal at 1 KHz
Rotary dial output	
Pulsing rate	10pps+0.8pps
Percent break	60/40% $\pm$ 2%
Inter digit interval	1000 ms typical
Leakage during break	>130 K $\Omega$
DTMF output	
Tone frequency error	$\pm$ 1.5% maximum
Tone level	-8 $\pm$ 2dBm combined (typical)
High versus low tone difference	4 dB maximum
Memory dialing	
Memory capacity	12 memories
Digit capacity	16 digits per memory
PBX pause duration	1-3.6 seconds
Fuse	250V, 250mA
Power source	4pcs 1.5V AAA batteries (not included)
Physical (Hook included)	
Measurement	218.5 $\times$ 69.5 $\times$ 49mm (8.6" $\times$ 2.7" $\times$ 1.9")
Weight	208g typical

Individual packing: Double blister



Upgraded



Robust protective holster



Accessories: Angled bed of nails & headset



Telephone line testing



High impedance monitor

## 400-028 Dual Telephone Line Tester



### Features:

This tool is for testing the condition of dual telephone line jacks. Multi-color LED indicator light alerts to okay line, reversed line, AC Voltage present and dead line. Fits in shirt pocket.

- Dual telephone line tester that troubleshoots common problem conditions with standard single or dual-line telephone hook-ups.
- Compact unit easily plugs into any single or dual-line telephone jack.
- Tests for three wiring conditions: correct, reversed and AC voltage presence.

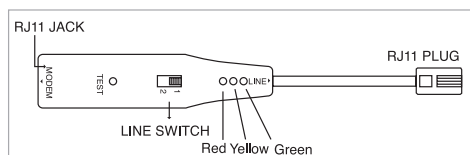

Individual packing: Blister card

## 902-267 / 902-459

### Replacement Test Leads for Butt Set



### Features:

- Professional grade "Bed of Nails" insulation piercing clips within the jaws
- Ultra-durable nylon braided jacket
- Guarantee ruggedness and flexibility
- Non-insulated ring terminals

Individual packing: Blister card

NEW



902-267

902-459

Model No.	Material	Butt set	Length	Color
902-267	Nylon/copper	400-042	60 inch	Red
902-459		MT-8006B	50 inch	Black

902-228

**All-in-One Toner & Probe Kit****V D V Tester (Voice/Data/Video)****Features:**

- Validate and troubleshoot wiring on RJ11/RJ45 cables, USB, F, BNC and RCA connectors.
- Detects telephone and Ethernet service, indicates polarity and active line numbers on voice circuits, and active pair number on Ethernet circuits
- Ideal for all maintenance fields of telecommunication, networking, datacom, Audio/Video, Cable TV and all weather cabling, etc...
- Locates cables quickly and easily
- Overcome noise and save time
- Tone on live networks safely and effectively
- Verify conductor continuity with cable map



Toner Specifications	
Tone frequency	1kHz
Tone mode	ONE/TWO-note tone
Compatible connectors	RJ-45/RJ-11/USB/F/BNC/RCA/Alligator Clips
Continuity test	<300Ω
Talk battery voltage	6V into 600Ω
Function selection	5-position rotary switch
Cable map indication	8 LED indicators
Voltage protection	100V
Low battery display	6.5V
Battery type	9V (6F22) (Included)
Dimension (LxWxD)	140x70x30mm / 5.5"x2.8"x1.2"

Receiver Specifications	
Frequency	1kHz
Compatible connectors	RJ-45/RJ-11/USB/F/BNC/RCA
Ear jack	1
Signal status indication	8 LED indicators
Cable map indication	8 LED indicators
Low battery display	6.5V
Battery type	9V (6F22) (Included)
Dimension (LxWxD)	250x52x33mm / 9.8"x2.0"x1.3"

Individual packing: Color box



Copper cabling detecting, including shielded (STP) and UTP cable



10 Base-T or 10/100 Base-T datacom networks

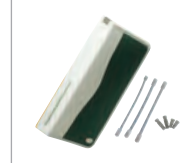

Locates and isolates cables quickly and easily

Accessories :  
1 zipper bag,  
2 RJ-45 cables,  
2 BNC connectors,  
2 RCA connectors.

400-011

**Tone Generator and Probe Kit**

Use it on de-energized AC wire, telephone/twisted pair wire, all voice and data category rated cable, speaker wire, virtually any cable or wire!

**Features:**

- Fast, accurate wire identification
- Rugged industrial design
- Sends tone to identify wires
- Three selectable tone outputs
- Two-line polarity indication
- Continuity test
- Adjustable volume control
- Visual signal strength indication
- Powerful speaker for noisy environments
- Recessed telephone test set connectors
- Battery: 9V(6F22) Included

**Tone Generator****Probe Amplifier**

Packaged in a soft nylon carrying case.

Individual packing: Blister card

## MT-7059 LCD Multifunction Cable Tester



LCD display, Wire tracing, LAN cable mapping, 9 different tone cable status indication

MT-7059 Transmitter specifications	
Indicator	LCD 53X25mm,with back light
Tone frequency	225kHz
Max. distance of transmission	2km
Max. distance of cable map	300m
Max. working current	≤ 70mA
Tone mode	9 Tone adjustable
Compatible connectors	RJ45(8 pin) · RJ11(6 pin) · BNC · USB · IEEE 1394
Continuity test	LCD (SHORT)
Max. signal voltage	1.5Vp-p
Function selection	3 Push button & 1 Power switch
Function and faults LCD display	LCD display (Wiremap : Tone : Short : Noadapter : UTP : STP : Low battery)
Cable map indication	LCD (#1-#8)
Shielded indication	LCD (#9)
Voltage protection	AC 60V / DC 42V
Low battery display	LCD (6.5V)
Battery type	DC 9.0V(NEDA 1604/ 6F22 DC9V ×1pcs)(Included)
Dimension (LxWxD)	185x80x32mm / 7.28"x3.15"x1.26"

MT-7059 Receiver specifications	
Frequency	225kHz
The Max. working current	≤ 70mA
Ear jack	1
LED illumination	2 LEDs
Battery type	DC 9.0V(NEDA 1604/ 6F22 DC9V ×1)(Included)
Dimension (LxWxD)	218x46x29mm / 8.58"x1.81"x1.14"

MT-7059 Remote unit specifications	
Compatible connectors	RJ-45(8 pin) · RJ-11(6 pin) · BNC · USB · IEEE 1394
Dimension (LxWxD)	107x30x24mm / 4.21"x1.18"x0.94"

### Features:

- Display test result on large LCD for easy reading and cable status identification
- The wire can be tracked directly in connection with Ethernet service, router, and PC terminal
- Validate and troubleshoot wiring on RJ11/RJ45 cables, Coaxial cable, USB cable, IEEE 1394 cable
- Test cable status for continuity, shorts, opens, miswired, crossover
- 9 different tones, cable selection for convenience use under different environment condition
- All installation and maintenance fields of telecommunication, networking, cable TV and more



Verify LAN cable condition



Wire Tracing

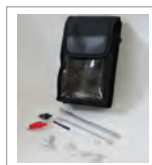

Accessories: earphone, RJ-45 cable, pouch bag



NEW

## MT-7025 Network Tone/Probe Kit



Wire tracing, LAN cable mapping, Cable status indication

MT-7025 Transmitter specifications	
Tone frequency	1kHz
Max. distance of transmission	2km
Max. distance of cable map	300m
Max. working current	≤ 45mA
Tone mode	ONE/TWO-note tone
Compatible connectors	RJ45(8 pin) · RJ11(6P/2C) · Alligator Clips
Continuity test	Yes
Max. signal voltage	8Vp-p
Function selection	3 Position mode switch
Cable map indication	8 LEDs
Shielded indication	1 LED
Phone line polarity indication	Yes
Voltage protection	AC 14V or DC 10V
Low battery display	6.0V
Battery type	DC 9.0V(NEDA 1604/ 6F22 DC9V ×1pcs)(Included)
Dimension (LxWxD)	126x49x34mm/4.96"x1.93"x1.34"

MT-7025 Receiver specifications	
Frequency	1kHz
The Max. working current	≤ 90mA
Compatible connectors	RJ45(8 pin)/RJ11(6 pin)
Ear jack	1
Signal status indication	1 LED & Buzzer
Cable map indication	8 LEDs
Shielded indication	1 LED
LED illumination	1 LED
Battery type	DC 9.0V (NEDA 1604/ 6F22 DC9V ×1pcs)(Included)
Dimension (LxWxD)	176x42x27mm / 6.93"x1.65"x1.06"

### Features:

- Locate up to 2KM long wire/cable even in a complex PC network or telephone system
- Quickly diagnose LAN cable condition and identify cable status
- Scan for continuity, open, short as well as reversal and crossed wiring
- Comes with LED light and earphone to enable work in dark and noisy environment
- All maintenance fields of telecommunication, networking, cable TV and more



Verify LAN cable condition



DC level testing function



Accessories: earphone, RJ-45 cable, pouch bag



NEW

## MT-7062 HDMI CABLE TESTER



For HDMI cables Type A, C

**NEW**



Accessory: Pouch bag x1

### Features:

- Test all HDMI cables with Type A to A, A to C and C to C connectors, especially for fragile, easily damaged HDMI patch cords and in-wall HDMI cables.
- Designed with loopback function which allows testing of HDMI type A to A, A to C on main unit.
- Automatically fast scan for testing all conductors status in a cable/Automatically slow scan for testing all conductors status in a cable/Manual test for step by step detecting individual conductors for intermittent faults.
- Automatically detect wiring on HDMI type A or type C condition in straight, short, open, crossover in all RGB conductors.
- Quickly troubleshoot and verify HDTV installation and DIY termination in the field.

### Specifications

Support test (main unit and remote unit)	19 pin-to-pin wire map and shielding detection
Test interface of Master unit	HDMI(type A)×2, Mini HDMI(type C)×1
Test interface of Remote unit	HDMI(type A)×1, Mini HDMI(type C)×1
Test Mode	Fast scan / Slow scan / Step by step
Beeper indication	Yes
Low battery indication	6.0V
Power source	DC 9V(NEAD 1604/6F22)×1 (not included)
Dimension	Main unit:103x66x27mm / 4.06"x2.60"x1.06" Remote unit:103x35x27mm / 4.06"x1.38"x1.06"
Package	Blister Card

## MT-7058 Mini Lan Cable Tester



RJ45, RJ-11/RJ-12, BNC cable tester, Voltage detector

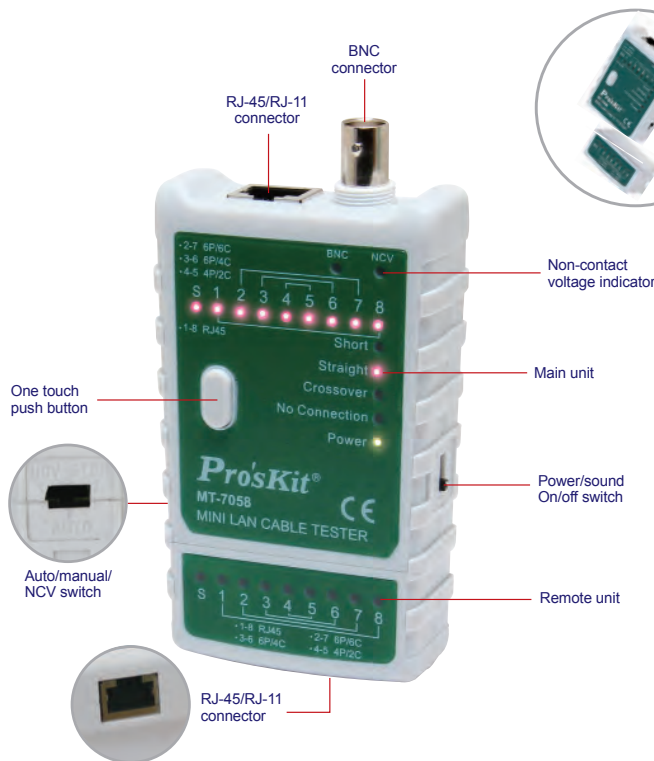

### Features:

- Complies with CE safety standard
- Automatically detect good connections, opens, crossed wires & split pairs
- Test RJ45 TIA568A/B (AT&T) 258A), 10 Base-T, Token ring, RJ-11/RJ-12 USOC and coaxial BNC cable
- Pin to pin cable map indicator
- Voltage detection for user safety
- Main unit and remote allow one person operation
- Compact size and lightweight design for easy to carry around
- Circuit protection design for both units
- Low power consumption with auto power off function to preserve battery
- Long cable test more than 300 meters(1000ft)

### Specifications

Function	Ground or shielded test
	1-8 LED pin to pin indicator
	No Connection indicator
	Crossover indicator
	Straight cable indicator
	Cable short indicator
	BNC cable indicator
	Non-contact detector(AC60V~240V 60Hz)
	Low battery indicator
	Beeper indicator
Size	100×60×24.5 mm / 3.94"×2.36"×0.96"
Power	12V AE23 x 1 pcs (Not included)
Accessory	Pouch bag x 1, BNC connector x 1



BNC cable test



RJ11 cable test



RJ45 cable test



Long cable test more than 300m(1000ft)



Non-contact voltage detection (AC60V~240V 60Hz)



Accessory

## 400-026 Multi-Modular Cable Tester



### Features:

- Tests RJ45 TIA568A/B (AT&T 258A), 10 Base-T, Token ring, RJ-11/ RJ-12 USOC and Coaxial BNC cable.
- Automatically check cable for continuity, short, open and crossed wire pairs.
- Coaxial cable port identifies cable conditions including shorts, shield opens and center conductor breaks.
- Main unit and remote allow one person testing.
- Power source: DC 9V Battery (Not included)
- Dimension: 102x106x28 (mm) / 4.0"x4.2"x1.1"
- Cable not included

Individual packing: Blister card



Accessories: Pouch bag and BNC connector



## MT-7057 Cable Sniffer-Remote



### Features:

- Simple one push-button operation.
- Power supplied by a 9V battery (Not included).
- Palm size design, easy to carry around.
- Detects open, short, miswired and cross-connected wire.
- Four types of connectors provided to test RJ-45, RJ-11, USB and BNC.

Individual packing: Color box



With RJ-45 connectors

With RJ-11 connectors



With USB connectors

BNC connector included



Accessories: Pouch bag and BNC connector



## ▶ 400-001 LAN Cable Tester With Remote

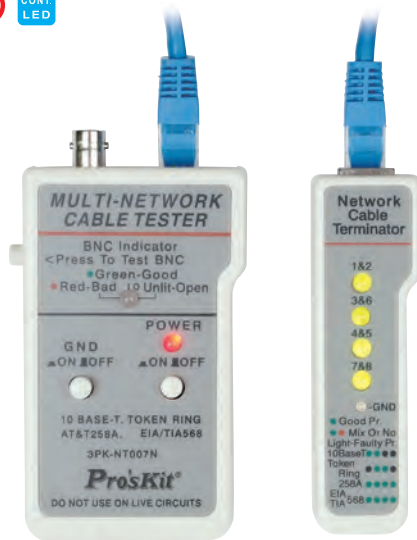

### Features:

- Multi-network cable tester is specified to quickly test by auto scanning wires continuity, mis-wiring and polarity in your network cables, thin Ethernet (BNC)/10 Base-T (UTP/STP)/356A/TIA-568A/TIA-568B/Token Ring. By using the attached remote terminator, you can easily test the cables before or after the cables are installed. It also allows you to test the ground of shielded twisted pairs cables.

Individual packing: Blister card



For BNC, RJ-45 twisted pair test



Accessories: Pouch bag and BNC connector

## ▶ 400-004 Multi-Modular Cable Tester

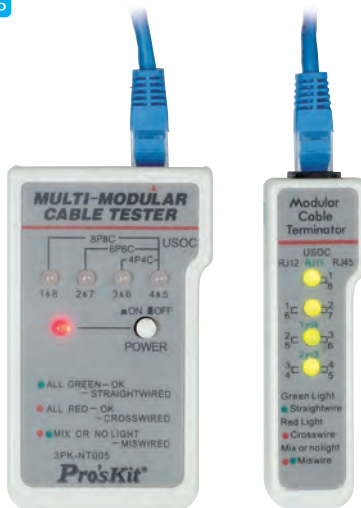

### Features:

- Multi-modular cable tester is specified to quickly test by auto scanning most of modular cables, USOC 4 / USOC6 / USOC 8 terminating with RJ 45, RJ12, and RJ11 modular plug, wires continuity and mis-wiring. It can also be used for testing if the cable is crossed pinning or straight through. Moreover, with the remote terminator, it can be further used in remote testing even when the cable has already been installed.

Individual packing: Blister card



Accessories: Pouch bag

## ▶ NT-3200 Mini-Pocket Tester Kit With Adaptors



### Features:

- Uses a type 23A~12V battery(Included)
- Improved head design with rugged push-on male F connector
- Easily viewable short circuit indicator
- Loud audio level for noisy environments
- Time-saving push-on female connector on audible toner
- Easily stores in shirt pocket or tool pouch

Individual packing: Color box

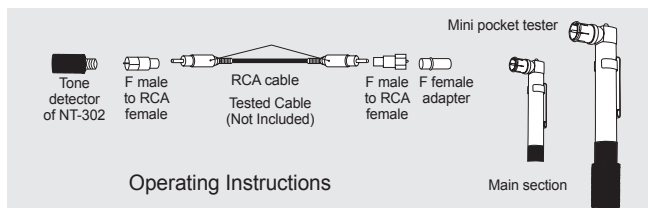

Operating Instructions

Main section

# Pro'sKit® Test Instruments

## Maximum display range and accuracy for digital multimeters and digital clamp meters and environmental meters

**rdg(reading)**  
The value on the digital display, readout.



**dgt(digit)**

Indicates the least significant digit. It represents the error used for processing fractions when converting from analog to digital.

### Maximum display range

MT-1860/1820: the maximum display range is "5999".  
MT-1232: the maximum display range is "3999".  
MT-1280/1270/1210: the maximum display range is "1999".  
For example of measuring resistance at MT-1232

Resistance	Display	
4000k	4.000M	The range is automatically switched so that the display unit is M or k
4000	4.000k	
40	40.00	The reading is display with three digits.

### Accuracy

When ACV measurement using the MT-1270, the maximum display value is 199.9V, minimum display value is 0.01V.



### Example

The accuracy of the AC200 V reading is  $\pm(0.8\%rdg+5dgt)$ .  
when measuring AC100V, the accuracy reading display range is 100.9~99.15.  
 $100V \pm (0.8\% + 5dgt)$   
 $= 100 + (0.80 + 0.05) \sim 100 - (0.80 + 0.05)$   
 $= 100.9 - 99.15$

## SI prefixes

Symbol	Prefixes	Decimal		Units frequently used
		Long Scale	Short Scale	
G	giga	1X1,000,000,000	1X10 <sup>9</sup>	GHz
M	mega	1X1,000,000	1X10 <sup>6</sup>	M , MHz
K	kilo	1X1,000	1X10 <sup>3</sup>	k , kW, kHz
m	milli	1/1,000	1X10 <sup>-3</sup>	mV, mA, mW, mF, mH
μ	micro	1/1,000,000	1X10 <sup>-6</sup>	μV, μA, μW, μF, μH
n	nano	1/1,000,000,000	1X10 <sup>-9</sup>	nA, nF, nH
p	pico	1/1,000,000,000,000	1X10 <sup>-12</sup>	pF, pH

**USB** USB connector



**V** DC voltage

**V** AC voltage

**A** DC current

**A** AC current

**Ω** Resistance

**Hz** Frequency

**+** Capacitance

**⊞** Inductor check

**°C/°F** Temperature °C/°F measurement

**°C** Temperature °C measurement

**Hz Duty** Duty cycle

**REL** Relative reference

**•••** Continuity buzzer

**CONT. LED** Continuity check

**▶** Diode test

**hFE** Transistor hFE test

**LED** LED test

**Battery** Battery check

**☀** Backlight

**MAX MIN** Maximum/Minimum value

**MAX HOLD** Maximum value hold

**HOLD** Data hold

**AP OFF** Auto power off

**🔋** Low battery

**0Ω ADJ** Zero-ohm adjuster

**OUT** Output terminal

Most of Pro'sKit test instruments are approved by CE EN61010-1 CATIII/ CATIII test.

CAT. II Primary circuits or equipments connected to low voltage facilities, such as a standard wall outlet.

CAT. III Equipment used for measurement in building facilities, distribution boards, and circuit breakers.



**RH** Hygrometer

**Air** Thermometer

**Lux** Light meter

**dB** Sound level meter

## ▶ MT-1860 Professional Digital Multimeter



### Mini USB connector to computer



- Features:**
- 3 5/6 digits 5999 counts.
  - 0.5% best accuracy.
  - Auto range.
  - USB connector for PC.
  - Dual display with analog bargraph.
  - Touch keys.
  - Extra functions: duty cycle, relative reference, backlight, Max/Min hold, data hold, auto power off, low battery indication.



Specification	
DCV	600m/6/60/600V ±(0.5%+4d), 1000V ±(1.0%+4d)
ACV	6/60/600V ±(0.8%+10d), 750V ±(1.0%+6d)
DCA	60m/600mA ±(1.0%+10d), 6/10A ±(1.2%+10d)
ACA	60m/600mA ±(1.5%+10d), 6/10A ±(2.5%+15d)
Resistance	600Ω ±(0.8%+5d), 6k/60k/600k/6MΩ ±(0.8%+4d), 60MΩ ±(1.2%+10d)
Frequency	10/100/1000/10k/100k/1M/20MHz ±(0.3%+2d)
Capacitance	40nF ±(5%+30d), 400n/4μ/40μF ±(3.5%+8d), 200μF ±(5.0%+10d)
Temperature	-20~400°C(0~750°F) ±(1.0%+5d), 400~1000°C(750~1832°F) ±(1.5%+15d)
Power source	AAA(1.5V)x2pcs (Not included)
Continuity with beeper	Y
Diode test	Y
Size	185×91×49 mm / 7.3"×3.6"×1.9"
Individual Packing	Color box

## ▶ MT-1820 Professional Digital Multimeter



### Mini USB connector to computer



- Features:**
- 3 5/6 digits 5999 counts.
  - 0.5% best accuracy.
  - Auto/Manual both range.
  - Mini USB connector for PC.
  - Dual display with analog bargraph.
  - Extra functions: duty cycle, relative reference, Max/Min hold, data hold, auto power off, low battery indication.



Specification	
DCV	600m/6/60/600V ±(0.5%+4d), 1000V ±(1.0%+6d)
ACV	6/60/600V ±(0.8%+10d), 750V ±(1.0%+10d)
DCA	600μ/6000μA ±(1.0%+10d), 60m/600mA ±(1.0%+10d), 6/10A ±(1.2%+10d)
ACA	600μ/6000μA ±(1.5%+10d), 60m/600mA ±(1.5%+10d), 6/10A ±(2.0%+15d)
Resistance	600Ω ±(0.8%+5d), 6k/60k/600k/6MΩ ±(0.8%+4d), 60MΩ ±(1.2%+10d)
Frequency	100/1000Hz ±(0.5%+4d), 10k/100kHz ±(0.5%+4d), 1M/20MHz ±(0.5%+4d)
Capacitance	40nF ±(5%+30d), 400n/4μ/40μF ±(3.5%+8d), 200μF ±(5.0%+10d)
Temperature	-20~400°C(0~750°F) ±(1.0%+5d), 400~1000°C(750~1832°F) ±(1.5%+15d)
Continuity with buzzer	Y
Diode test	Y
Transistor test	Y
Power source	AAA(1.5V)x2pcs (Not included)
Size	192×95×48 mm / 7.6"×3.7"×1.9"
Individual Packing	Color box

## ▶ MT-1710 True-RMS Auto Range Multimeter



### CE CAT IV 600V AC True-RMS

- Features:**
- 3 3/4 digits 3999 counts.
  - 0.5% best accuracy.
  - Both Auto and Manual range.
  - AC True-RMS for accurate measurements.
  - Extra functions: Continuity with beeper, Diode test, Transistor test, Duty cycle, Relative reference, Data hold, Auto power off, Low battery indication, Input alert, LCD backlight.
  - Ideal for a wide variety of electrical and electronic testing applications.



Specification	
DC Voltage (V)	400m/4/40/400V ±(0.5%+4d), 1000V ±(1.0%+6d)
AC Voltage (V) True-RMS	40~1kHz(sine and triangular wave) and 40~200Hz(other wave): 400mV ±(1.6%+8d), 4/40/400/750V ±(1.0%+10d) 200~1kHz(other wave): 400m/4/40/400/750V ±(8.0%+15d)
DC Current (A)	400μ/4000μA ±(1.0%+10d), 40m/400mA ±(1.2%+8d), 10A ±(1.2%+10d)
AC Current (A) True-RMS	40~1kHz(sine and triangular wave) and 40~200Hz(other wave): 400μ/4000μ/40m/400mA ±(1.5%+10d), 10A ±(2.0%+15d) 200~1kHz(other wave): 400μ/4000μ/40m/400mA/10A ±(8.0%+15d)
Resistance (Ω)	400Ω ±(0.8%+5d), 4k/40k/400k/4MΩ ±(0.8%+4d), 40MΩ ±(1.2%+10d)
Frequency (Hz)	100/1000/10k/100kHz ±(0.5%+10d), 1M/30MHz ±(0.5%+10d)
Capacitance (F)	10n ±(5.0%+20d), 100n/1μ/10μ/100μF ±(3.5%+8d), 1/10/100mF ±(5.0%+10d)
Temperature (°C/°F)	-20~400°C(4~752°F) ±(1.0%+5d), 400~1000°C(752~1832°F) ±(1.5%+15d)
Power source	9V (NEDA 1640/6F22) battery
Size	190×95×45 mm / 7.4"×3.7"×1.76"
Individual Packing	Color box



**MT-5210 3 1/2 LCR Meter**











**Inductance/Capacitance/Resistance**

**Measurement 3 in 1****Features:**

- 3 1/2 digits 1999 counts.
- LCD display for low power consumption and clear readout even in bright ambient light conditions.
- Inductance measurement : 2mH to 20H.
- Capacitance measurement : 2nF to 1000µF.
- Resistance measurement : 200Ω to 20MΩ.
- Extra function : data hold, low battery indication.

Specification	
Inductance	2m/20m/200mH ±(2.0%+5d), 2H ±(5.0%+5d), 20H ±(5.0%+15d)
Capacitance	2n/20n/200nF ±(1.0%+5d), 2µ/20µF ±(2.0%+5d), 200µF ±(5.0%+5d), 1000µF ±(5.0%+25d)
Resistance	200Ω±(0.8%+5d), 2k/20k/200k/2MΩ±(0.8%+3d), 20MΩ ±(1.0%+15d)
Diode Test	Y
Transistor Test	Y
Continuity buzzer	Y (with light up)
Power source	NEDA1604/6F22 (9V) x 1pcs(Not included)
Size	189 x 97 x 35 mm / 7.4"x3.8"x1.4"
Individual packaging	Color box



Test probes, alligator clips

**MT-5110 3 1/2 Capacitance Meter**







**Capacitance Measurement 0.1pF~20,000µF.**

**Features:**

- 3 1/2 digits 1999 counts.
- Complies with the newest CE safety standard
- High measuring accuracy: ±0.5%.
- Measurements are possible even under a strong magnetic field.
- LCD display with big digit for clear readout even in bright ambient.
- Zero knob: Knob to zero when testing low capacitance.
- Extra function: LCD backlight, low battery indication.

Specification	
Capacitance	200pF ±(0.5%+7d), 2n/20n/200n/2µ/20µ/200µF ±(0.5%+5d), 2,000µF ±(2.0%+5d), 20,000µF ±(3.0%+10d)
Zero adjustment	Manual (range:±20pF)
Over-input	Display shows "1"
Input overload protections	Y
Sampling time	0~5 second
EN61010-1	CE
Power source	NEDA1604/6F22 (9V) x 1pcs (Not included)
Size (HXWXD)mm	182x90x46mm/7.2"x3.5"x1.8"
Test Lead model no.	MT-9906
Individual packing	Color box



Capacitance test socket



Alligator clips

**MT-1705 3 1/2 True-RMS Multimeter**

















**AC True-RMS**

**Features:**

- 3 1/2 digits 1999 counts.
- 0.5% best accuracy.
- Auto polarity indication.
- AC True-RMS for accurate measurements.
- Large backlight LCD display for easy reading.
- Extra Function: Continuity with beeper, Diode test, Data hold, Auto power off, Low battery indication, Overload indication, LCD backlight
- Frequency and Capacitance are auto range
- Ideal for wide variety of electrical and electronic testing applications.

Specification	
DC Voltage (V)	200mV/2V/20V/200V±(0.5%+3d), 600V±(1.0%+10d)
AC Voltage (V) True-RMS	40Hz-200Hz and 200Hz-1KHz Sine and triangular wave, 2V/200V±(0.8%+5d), 600V±(1.2%+10d)
DC Current (A)	200Hz-1KHz other wave, 2V/200V/600V±(8.0%+15d)
AC Current (A) True-RMS	20mA/200mA±(1.2%+8d), 10A±(2.0%+5d)
Resistance (Ω)	40Hz-200Hz and 200Hz-1KHz Sine and triangular wave, 200mA±(1.5%+15d), 10A±(3.0%+10d)
Frequency (Hz)	200Hz-1KHz Other wave, 200mA/10A±(8.0%+15d)
Capacitance (F)	200Ω±(0.8%+5d), 20K/200K±(0.8%+3d), 20M±(1.0%+25d)
Power source	10/100/10k/100k/2M Hz±(1.0%+10d)
Size	20nF/200nF/2µF±(3.5%+20d), 20µF/200µF/2000µF±(5.0%+10d)
Individual Packing	3V(1.5VAAA*2)
	150x73.5x35 mm / 5.9"x2.89"x1.18"
	Color box

**NEW**

## ▶ MT-1217 3 3/4 Auto Range Digital Multimeter

**NEW**



### Features:

- Complies with newest CE safety standard
- 3 3/4 digits 3999 counts
- Large and easy to read display panel
- Overload and resettable fuse protection circuit design
- Extra function: Auto range, relative reference, backlight, data hold, auto power off, low battery indication



transistor test socket, thermocouple probe



Test lead



Specification	
DCV	400mV/4V/40V/400V ±(0.5%+4d), 1000V ±(1.0%+6d)
ACV	4V/40V/400V ±(0.8%+6d), 750V ±(1.0%+10d)
DCA	400µA/4000µA ±(1.0%+10d), 40mA/400mA ±(1.0%+10d), 4A/10A ±(1.2%+10d)
ACA	400µA/4000µA ±(1.5%+10d), 40mA/400mA ±(1.5%+10d), 4A ±(2.0%+15d); 10 A ±(2.5%+15d)
Resistance	400Ω ±(0.8%+5d), 4k/40k/400KΩ/4MΩ ±(0.8%+4d), 40MΩ ±(1.2%+10d)
Frequency	400/4K/20KHz ±(0.5%+10d)
Capacitance	40nF ±(0.5%+30d), 400nF/4µF/20µF ±(3.5%+8d)
Temperature	(-20°C~1000°C) < 400°C ±(1.0%+5d) (-20°C~1000°C) ≥ 400°C ±(1.5%+15d)
Duty Cycle	0.1%~99.9%
Continuity with beeper	Y Diode Test Y
Transistor hFE test	Y (with socket)
Fuse	0.4A/250V Resettable fuse, 10A/250V Fuse
Power source	9V*1(not included)
Size (HxWxD)mm	182*90*46mm Test leads model no. MT-9906
Individual packing	Color Box

## ▶ MT-1280 Professional Digital Multimeter



### Features:

- 3 1/2 digits 1999 counts
- 0.5% best accuracy
- Resettable fuse protection
- Complies with the newest CE safety standard
- Extra functions: Auto power off, low battery indication, LCD backlight, data hold, LED indicator

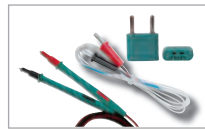

Accessories: test leads, transistor test socket, thermocouple probe



Specification	
DC Voltage	200mV/2V/20V/200V ±(0.5%+3d), 1000V ±(0.8%+10d)
AC Voltage	2V/20V/200V ±(0.8%+5d), 750V ±(1.2%+10d)
DC Current	200µA/20mA ±(0.8%+10d), 200mA ±(1.2%+8d), 20A ±(2.0%+5d)
AC Current	20mA ±(1.0%+5d), 200mA ±(2.0%+5d), 20A ±(3.0%+10d)
Resistance	200Ω ±(0.8%+5d), 2K/20K/200KΩ ±(0.8%+3d), 20MΩ ±(1.0%+25d), 200MΩ ±(5.0%+10d)
Capacitance	20nF ±(2.5%+20d), 20µF ±(2.5%+20d), 200µF ±(5.0%+20d)
Temperature	-20°C~400°C ±(1.0%+5d), 400°C~1000°C ±(1.5%+15d)
Continuity with beeper	Y
Diode test	Y
Transistor test	Y
Battery	9V(6F22) (Not Included)
Size (HxWxD)mm	182x90x46/7.2"x3.5"x1.8"
Individual packing	Color box

## ▶ MT-1270 Digital Multimeter



### Features:

- 3 1/2 digits 1999 counts
- 0.5% best accuracy
- Complies with the newest CE safety standard
- Resettable fuse protection
- Extra functions: data hold, auto power off, low battery indication, LCD backlight



Accessories: test leads, transistor test socket, thermocouple probe



Specification	
DC Voltage	200mV/2V/20V/200V ±(0.5%+3d), 1000V ±(0.8%+10d)
AC Voltage	2V/20V/200V ±(0.8%+5d), 750V ±(1.2%+10d)
DC Current	2mA/20mA ±(0.8%+10d), 200mA ±(1.2%+8d), 10A ±(2.0%+5d)
AC Current	2mA ±(1.0%+15d), 200mA ±(2.0%+5d), 10A ±(3.0%+10d)
Resistance	200Ω ±(0.8%+5d) 2K/20K/200K/2MΩ ±(0.8%+3d) 20MΩ ±(1.0%+25d) 200MΩ ±(5% (reading-10)+30d]
Frequency	20K Hz ±(1.5%+4d)
Capacitance	2nF ±(4.0%+20d), 20nF ±(4.0%+20d), 200nF ±(4.0%+20d), 2µF ±(4.0%+20d), 20µF ±(5.0%+30d)
Temperature	(-20°C~1000°C) ±(2.0%+2d)
Diode Test	Y
Transistor Test	Y
Continuity with beeper	Y
Battery	9V(6F22) (Not Included)
Size (HxWxD)mm	182x90x46/7.2"x3.5"x1.8"
Test Lead model no.	MT-9906
Individual packing	Color box

## MT-1232 3 3/4 Autorange Digital Multimeter



Specification	
DC Voltage	400mV/4V/40V/400V ±(0.5%+4d), 600V ±(1.0%+4d)
AC Voltage	4V/40V/400V ±(0.8%+6d), 600V ±(1.0%+6d)
DC Current	400μA/4,000μA ±(1.0%+10d), 40mA/400mA ±(1.0%+10d), 10A ±(1.2%+10d)
AC Current	400μA/4,000μA ±(1.5%+10d), 40mA/400mA ±(1.5%+10d), 10A ±(2.5%+15d)
Resistance	400Ω ±(0.8%+5d), 4k/40k/400k/4MΩ ±(0.8%+4d), 40MΩ ±(1.2%+10d)
Frequency	1/10/100Hz ±(0.5%+10d), 1K/10K/100KHz ±(0.5%+10d), 1/10MHz ±(0.5%+10d)
Capacitance	4nF ±(0.5%+9d), 40nF/400nF/4μF/40μF ±(3.5%+8d), 100μF ±(5.0%+8d)
Temperature	(-20C~1000C) < 400C ±(1.0+5d), (-20C~1000C) >= 400C ±(1.5+15d)
Duty Cycle	0.1% ~ 99.9%
Continuity with beeper	Y
Diode test	Y
Fuse	10A/250V
Power source	1.5V AA x 2 (not included)
Size	147x78x41mm/5.8"x3.1"x1.6"
Test leads model no.	MT-9907
Individual packing	Color box

### Features:

- 3 3/4 digits 3999 counts
- Complies with the newest CE safety standard
- Overload and mis-use protection
- Resettable fuse protection
- Extra functions: Relative reference, backlight, data hold, auto power off, low battery indication.



Accessories: test leads, transistor test socket, thermocouple probe



## MT-1132 3 1/2 Digital Multimeter



Specification	
DC Voltage	200mV/2V/20V/200V ±(0.5%+2d), 500V ±(0.8%+5d)
AC Voltage	200V ±(1.2%+10d), 500V ±(1.2%+10d)
DC Current	200μA/2mA/20mA/200mA ±(1.0%+5d), 10A ±(2.5%+5d)
Resistance	200Ω ±(0.8%+5d), 2K/20K/200K ±(0.8%+5d), 2MΩ ±(1.0%+5d)
Continuity with beeper	Y
Diode Test	Y
Transistor hFE test	Y
LED test	Y
Battery check	Y (1.5V)
Fuse	10A/250V
Power source	1.5V AA x 2 (not included)
Size	147x78x41mm/5.8"x3.1"x1.6"
Test leads model no.	MT-9907
Individual packing	Color box

### Features:

- 3 1/2 digits 1999 counts
- Complies with the newest CE safety standard
- Large and easy to read display panel
- Overload and mis-use protection
- Extra functions: backlight, data hold, low battery indication.
- User friendly interface is ideal for students, DIY market, home applications and more



Accessories: test leads, transistor test socket, thermocouple probe



## MT-1630 3 1/2 Pen-Style Meter

### Pen type compact in size DMM



Specification	
DCV	200m/2/20/200/600V ±(0.8%+5d)
ACV	2/20/200V ±(1.0%+3d), 600V ±(1.2%+3d)
DCA	20m/200mA ±(1.5%+10d)
ACA	20m/200mA ±(3.0%+10d)
Resistance	200Ω ±(1.0%+5d), 2k/20k/200k/2MΩ ±(1.0+3d), 20MΩ ±(1.2%+5d)
Continuity with beeper	Y
Diode test	Y
Over range indication	Y
Sampling rate	Approximately 3 times per sec.
Fuse protection	Y
Power source	LR44(1.5V)x2 pcs (not included)
Size	205 x 35 x 30 mm / 8.1"x1.4"x1.2"
Individual packing	Double blister

### Features:

- 3 1/2 digits 1999 counts.
- 0.8% best accuracy.
- Auto range.
- Compact in size, light in weight and simple to use.
- Penlight brightly illuminates the point to be measured, even in dark places.
- Unique protection mechanism for the test probe for safety.
- Extra functions: auto power off, data hold, low battery indication.



## ▶ MT-1233C 3 1/2 Digital Multimeter

**NEW**



Accessories:  
Test leads, thermocouple probe

**LCD backlight, Data hold, °C and °F temperature test, Palm Size.**



### Features:

- Complies with the newest CE safety standard
- 3 1/2 digits 1999 counts
- Palm size for easy storage and carrying
- Extra functions: backlight, data hold, low battery indication, overload protection indication
- User friendly interface is ideal for students, DIY market. home applications and more

Specification	
DCV	200m/2000m/20/200V ±(0.8%+3d), 500V ±(1.0%+3d)
ACV	200/500V ±(1.2%+5d)
DCA	2000u/20m/200mA ±(1.2%+5d), 10A ±(2.5%+5d)
Resistance	200Ω ±(1.5%+5d), 2000/20k/200kΩ ±(1.0%+3d), 20MΩ ±(1.0%+3d)
Temperature	-40~150°C ±(1.0%+3d), 150~1000°C ±(1.5%+15d) -40~302°F ±(1.0%+4d), 302~1832°F ±(1.5%+15d)
Continuity with beeper	Y Diode test Y
Power source	1.5V AAA x 2 (not included)
EN61010-1	CE/CAT I 600V, CATII 300V
Size	130 x 72 x 28mm / 5.1"x2.8"x1.1"

Individual packing: Double blister

## ▶ MT-1233D 3 1/2 Digital Multimeter

**NEW**



Accessories: Test leads

**LCD backlight, Data hold, High resistance test, Square signal output, Palm Size.**



### Features:

- Complies with the newest CE safety standard
- 3 1/2 digits 1999 counts
- Palm size for easy storage and carrying
- Extra functions: backlight, data hold, low battery indication, overload protection indication
- User friendly interface is ideal for students, DIY market. home applications and more

Specification	
DCV	200m/2000m/20/200V ±(0.8%+3d), 500V ±(1.0%+3d)
ACV	200/500V ±(1.2%+5d)
DCA	2000u/20m/200mA ±(1.2%+5d), 10A ±(2.5%+5d)
Resistance	200Ω ±(1.5%+5d), 2000/20k/200kΩ ±(1.0%+3d) 20MΩ ±(1.0%+5d), 200MΩ ±(1.0%(rdg-10)+10d)
Square signal output	50Hz (5 Vp-p, 50KΩ)
Continuity with beeper	Y Diode Test Y
Power source	1.5V AAA x 2 (not included)
EN61010-1	CE/CAT I 600V, CATII 300V
Size	130 x 72 x 28mm / 5.1"x2.8"x1.1"

Individual packing: Double blister

## ▶ MT-1210 3 1/2 Digital Multimeter



Transistor hFE test



Back light

**With backlight, data hold, economic type.**



### Features:

- 3 1/2 digits 1999 counts.
- 1% best accuracy.
- Extra functions: backlight, data hold, low battery indication.

Specification	
DCV	200m/2/20/200V ±(1.0%+2d), 500V ±(1.2%+5d)
ACV	200/500V ±(2.5%+10d)
DCA	200μ/2m/20m/200mA ±(2.0%+5d), 10A ±(3.0%+5d)
Resistance	200Ω/2k/20k/200kΩ ±(1.0%+5d), 2MΩ ±(1.5%+5d)
Continuity with beeper	Y
Diode test	Y
Transistor hFE test	Y
Power source	NEDA1604/6F22 (9V) x 1pcs(Not included)
Size	144x70x32 mm / 5.7"x2.8"x1.3"
Individual package	Double blister

## MT-3109 AC/DC Digital Clamp Multimeter

AC/DC current, Frequency, Capacitance measurement.

CAT II 600V

Specification	
DCV	400mV $\pm(1.0\%+3d)$ , 40/400V $\pm(1.0\%+1d)$ , 600V $\pm(1.0\%+5d)$
ACV	4/40/400V $\pm(1.2\%+5d)$ , 600V $\pm(1.5\%+5d)$
DCA	40A $\pm(2.5\%+5d)$ , 400A $\pm(2.5\%+3d)$
ACA	40A $\pm(3.0\%+8d)$ , 400A $\pm(3.0\%+5d)$
Resistance	400 $\Omega$ $\pm(1.2\%+5d)$ , 4k/40k/400k $\Omega$ $\pm(1.0\%+5d)$ , 4M $\Omega$ $\pm(1.2\%+5d)$ , 40M $\Omega$ $\pm(1.5\%+5d)$
Frequency	10/100/1k/10k/100k/1MHz $\pm(0.1\%+5d)$ , 10MHz (For reference only)
Capacitance	40n/400n/4 $\mu$ /40 $\mu$ F $\pm(5.0\%+10d)$ , 100 $\mu$ F $\pm(6.0\%+10d)$
Diode test	Y
Continuity with Buzzer	Y
Power Source	AAA(1.5V) x 3 pcs (Not included)
Size	203 x 68 x 33 mm / 8.0"x2.7"x1.3"
Individual Packing	Double Blister

### Features:

- 3 3/4 digits 3999 counts
- 1.0% best accuracy.
- Auto range.
- Overload protection.
- Extra function: duty cycle, relative reference, data hold, sleep mode, auto power off, low battery indication.
- Jaw Opening Size: max. 30mm

AC / DC  
Measurement



ACA measurement



DCA measurement



## MT-3102 3 1/2 2A Mini Digital Clamp Meter

AC current 2A, Temperature measurement.

CAT II 600V

Specification	
DCV	200mV $\pm(0.8\%+5d)$ , 2/20/200V $\pm(0.8\%+3d)$ , 600V $\pm(1.0\%+5d)$
ACV	2/20/200V $\pm(1.2\%+5d)$ , 600V $\pm(1.5\%+5d)$
ACA	2A $\pm(3.0\%+15d) \leq 0.4A \pm(4.0\%+20d)$ , 20A $\pm(2.0\%+10d) \leq 0.4A \pm(3.0\%+15d)$ , 200/400A $\pm(2.0\%+5d)$
Resistance	200 $\Omega$ $\pm(1.2\%+5d)$ , 2k/20k/200k $\Omega$ $\pm(1.0\%+3d)$ , 2M $\Omega$ $\pm(1.2\%+5d)$ , 20M $\Omega$ $\pm(1.5\%+5d)$
Temperature °C/°F	-40~0°C $\pm(3.0\%+4d)$ , 0~400°C $\pm(1.0\%+3d)$ , 400~1000°C $\pm(2.0\%+10d)$ -40~32°F $\pm(3.0\%+8d)$ , 32~752°F $\pm(1.0\%+6d)$ , 752~1832°F $\pm(2.0\%+18d)$
Diode test	Y
Continuity with beeper	Y
Power source	AAA(1.5V) x 3 pcs (Not included)
Size	203 x 68 x 33 mm / 8.0"x2.7"x1.3"
Individual packing	Double blister

### Features:

- 3 1/2 digits 1999 counts.
- 0.8% best accuracy.
- Auto range.
- Portable and simple one-hand operation.
- Extra function: Maximum value hold, data hold, auto power off, low battery indication.
- Max. jaw opening: max. 30mm.



ACA measurement



## MT-3266 3 1/2 Hand Held Digital Clamp Meter

CAT II DC 1000V  
AC 750V

Specification	
DCV	1,000V $\pm(0.8\%+2d)$
ACV	750V $\pm(1.2\%+4d)$
ACA	200/1,000A $\pm(3.0\%+5d)$
Resistance	200 $\Omega$ $\pm(1.0\%+3d)$ , 20k $\Omega$ $\pm(1.0\%+1d)$
Continuity with beeper	Y
Power Source	NEDA1604/6F22 (9V) x 1 pcs(Not included)
Size	230 x 70 x 37 mm / 9.1"x2.8"x1.5"
Individual package	Double blister

### Features:

- 3 1/2 digits 1999 counts.
- 0.8% best accuracy.
- Portable and simple one-hand operation.
- Extra function: data hold, low battery indication.
- Max. jaw opening: max. 50mm.
- Comes with zippered pouch.

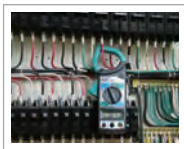

ACA measurement



## MT-3105 Smart Clamp Meter

### Features:

- 3 3/4 digits 3999 counts.
- 0.7% best accuracy.
- Auto range.
- Auto selection DCV, ACV, ACA, Resistance.
- Non-contact voltage detector of ACV.
- 10 sets data store & read.
- Extra function: backlight, data hold, auto power off, low battery indication.
- Jaw Opening Size: max.42mm.



Non-contact voltage detection



ACA Measurement



One Touch

### Auto-selection function, Non-contact ACV detector.



Specification	
DCV	4/40/400V $\pm(0.7\%+4d)$ , 600V $\pm(0.8\%+5d)$
ACV	4/40/400V $\pm(0.8\%+4d)$ , 600V $\pm(1.2\%+4d)$
ACA	40/400A $\pm(1.8\%+5d)$
Resistance	400 $\Omega$ /4k/40k/400k/4M $\Omega$ $\pm(0.8\%+2d)$ , 40M $\Omega$ $\pm(2.0\%+5d)$
EF Detection(NCV)	15V-55V "--" 30V-85V "- -" 55V-145V "- - -" Above 120V "- - - -"
Continuity with beeper	Y
Power Source	AA(1.5V)x2pcs (not included)
Size	220x76.5x48.5 mm / 8.7"x3.0"x1.9"
Individual package	Color box

## MT-2017 Protective Function Analog Multimeter

### Features:

- Double-sided glass epoxy PCB.
- Mirrored Aluminum dial plate.
- Overload and mis-used protection via two fuses, oxide varactor & diodes.
- Robust protective holster alongside.
- 20k $\Omega$ /V DC & 9 k $\Omega$ /V AC input sensitivity.
- Adjustable back tilt device with hook-up design.
- Ideal for using in the fields of lab, school, home applications and more.



Double-sided glass epoxy PCB



Adjustable back tilt device with hook-up

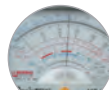

NULL DCV measurement



Including test leads, batteries & fuses

### With Null DCV, Capacitance measurement



CE CAT II 1000V CAT III 600V

Specification	
DCV	0.1/2.5/10/50/250V $\pm 3.0\%$ FSD, 1000V $\pm 4.0\%$ FSD
Null DCV	DC $\pm 5V/\pm 25V \pm 5.0\%$ FSD
ACV	10/50/250V $\pm 4.0\%$ FSD, 1000V $\pm 5.0\%$ FSD
DCA	50 $\mu$ /2.5m/25m/250mA $\pm 3.0\%$ FSD, 10A $\pm 4.0\%$ FSD
Resistance	$\times 1(0.2-2k\Omega) / \times 10(2-20k\Omega) / \times 100(20-200k\Omega) /$ $\times 1k(200-2M\Omega) / \times 10k\Omega(2k-20M\Omega) \pm 4.0\%$ ARC
Capacitance	C1(R $\times 1k$ ): 2000 $\mu$ F(Approx.), C2( $\times 50\mu$ A): 0.025 $\mu$ /0.25 $\mu$ /25 $\mu$ $\pm 3.0\%$ FSD(Option MT-2007-C)
Battery check	1.5V/9V
Transistor hFE test	Y
Diode & LED test	Y
Continuity with beeper	Y
Front Panel Controls	Range selector switch with "OFF" position, 0 $\Omega$ adjust knob
Power source	AA(1.5V) x 2pcs and NEDA1604/6F22 (9V) x 1 pcs
Size	160 x 105 x 40 mm / 6.3"x4.1"x1.6"
Individual packing	Color box

## MT-2018 Protective Function Analog Multimeter

### Features:

- Mirrored Aluminum dial plate.
- Overload and mis-used protection via two fuses, oxide varactor & diodes.
- Robust protective holster alongside.
- 20k $\Omega$ /V DC & 9 k $\Omega$ /V AC input sensitivity.
- Adjustable back tilt device with hook-up design.
- Ideal for using in the fields of lab, school, home applications and more.

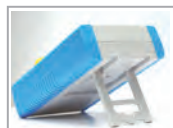

Adjustable back tilt device with hook-up



Including test leads, batteries & fuses

### With capacitance measurement



CE CAT II 1000V CAT III 600V

Specification	
DCV	0.1/0.5/2.5/10/50/250V $\pm 3.0\%$ FSD, 1000V $\pm 4.0\%$ FSD
ACV	10/50/250V $\pm 4.0\%$ FSD, 1000V $\pm 5.0\%$ FSD
DCmA	50 $\mu$ /2.5m/25m/250mA $\pm 3.0\%$ FSD
Resistance	$\times 1(0.2-2k\Omega) / \times 10(2-20k\Omega) / \times 100(20-200k\Omega) /$ $\times 1k(200-2M\Omega) / \times 10k\Omega(2k-20M\Omega) \pm 4.0\%$ ARC
Capacitance	C1(R $\times 1k$ ): 2000 $\mu$ F(Approx.), C2( $\times 50\mu$ A): 0.025 $\mu$ /0.25 $\mu$ /25 $\mu$ $\pm 3.0\%$ FSD(Option MT-2007-C)
Battery Check	1.5V/9V
Transistor hFE test	Y
Diode & LED test	Y
Front Panel Controls	Range selector switch with "OFF" position, 0 $\Omega$ adjust knob
Power Source	1.5V AA x 2pcs and 9V(NEDA1604) x 1pcs
Size	160 x 105 x 40 mm / 6.3"x4.1"x1.6"
Individual Packing	Color box

## MT-4017 Light Intensity Meter



### Features:

- 6 digits LCD display.
- Portability and simplicity one-hand operation
- Extra functions: data hold, auto power off, low battery indication, Max/Min mode.
- Ideal for light measuring in office, library, hospital or home use and more.

Specification	
Parameters	Lux(lm/m <sup>2</sup> ); foot candle (lm/ft <sup>2</sup> )
Range	0-90000 Lux; 0-8300.0 ftc
Accuracy	±(3% +30d) to reference
Sample rate	1 time/sec
Resolution	1 Lux( 0-90000 Lux), 0.1 ftc(0-8300.0 ftc)
Power source	AAA(1.5V) x 3pcs (Not Included)
Size	157 x 60 x 30 mm / 6.2"x2.4"x1.2"
Individual packing	Carrying Case + Color Box



Box



Cover and wrist strap included



## MT-4018 Sound Level Meter



### Features:

- 4 digits LCD display.
- Dual display with analog bargraph.
- Auto / Manual range.
- Extra functions: auto power off, low battery indication, Sound OVER or UNDER display
- Usually apply to traffic, factory, office for sound level monitoring

Specification	
Microphone	Electret condenser microphone
Response frequency	31.5Hz-8KHz
Frequency weighting	A Type
Range	30-60dB, 50-80dB, 70-100dB, 90-120dB
Resolution	0.1 dB
Accuracy	30-60dB ±3 dB; 60-120dB ±2 dB
Time response	Analog bar: 125ms ; Digital :750ms
Power source	AAA(1.5V) x 3pcs (Not Included)
Size	175 x 60 x 32 mm / 6.9"x 2.4"x1.3"
Individual Packing	Carrying Case + Color Box



Box



Cover and wrist strap included



## MT-4011 K Type Digital Thermometer



**Ideal For use in labs, industrial control and audits and measuring differential temperature T1/T2.**

### Features:

- Large LCD displays (LCD 18.2mm): 4 Digital liquid crystal display.
- Dual K type probe input.
- T1, T2 or T1-T2 dual channel display.
- 10 set data memory function.
- Function: °C/°F selection, Max/Min reading, Data Hold, Relative reference, Memory, Limit, Hi/Lo, T1-T2 Type.
- Extra function: Auto power off, Low battery indication.

Specification	
Measurement range	K Type : -200~-1372°C (-328-2501°F)
Accuracy	±(0.2%+1°C): -250 ~ -100°C ; ±(0.1%+0.7°C):-100 ~ 1372°C ; ±(0.2%+2°F):-418 ~ -148°F ±(0.1%+1.4°F):-148 ~ 2501°F
Resolution	0.1°C/0.1°F (below 1000°C), 1°C/1°F (above 1000°C)
Power source	AAA/UM-4(1.5V) X 4pcs (not included)
Size	125 X 82 X 43 mm / 4.9"x3.2"x1.7"
Accessories	K-type thermocouple wire x 2pcs(Included)
Individual packing	Sleeve with white box



Dual probe input



T1, T2 dual channel



## NT-6540 Laser Distance Measurer

Most thin/Compact design/Ease of ease



**NEW**

**40M**  
measurement



### Features:

- Easily and quickly measuring up to 40M.
- Complies with IP54 rated as dust and water resistant.
- Auto laser off and auto power off function, power saving.
- LCD display with backlight allows for data reading in dark areas.
- Ideal for measuring room dimension for cooling, home layout, cable linear length, align large fixtures, house maintenance.

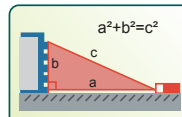

Pythagorean theorem calculation

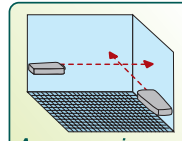

Area measuring

Specifications	
Display	LCD display (2 lines)
Backlight	Yes
Measuring range	0.1-40M
Accuracy	±2mm
Unit selection	m/ft/in/ft+in
Continuous measurement	Yes
Area calculations	Yes
Memory	10 records
Buzzer indication	Yes
Pythagorean 1	Yes
Auto laser off	After 20 second
Auto power off	After 3 min
Laser Class	Class II
Laser type	650 nm, < 1mW
Certificate	IP54
Operating Temperature	0°C to +40°C(32°F to 104°F)
Storage Temperature	-10 °C to+60°C (14°F to 140°F)
Battery type	Type AAA 2 x 1.5V
Battery life	Up to 5000 time(only for reference)
Dimension	100x43x28mm/ 3.93"x1.70"x1.10"
Weight(not include batteries)	60g
Individual Packing	Double Blister Card

## NT-6560 Laser Distance Measurer



**NEW**

**60M**  
measurement



### Features:

- Integrated multi-measuring functions.
- Easily and quickly measuring up to 60M.
- Auto laser off and auto power off function, power saving.
- 4-Line display with backlight allows for data reading in dark areas.
- Ideal for measuring office layout, check tank level, cell tower setting, hole depth, electrical safety area.

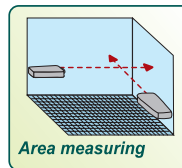

Area measuring

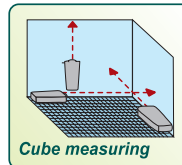

Cube measuring

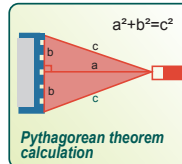

Pythagorean theorem calculation

Specifications	
Display	LCD display ( 4 lines)
Backlight	Yes
Measuring range	0.2-60M
Accuracy	±2mm
Unit selection	m/ft/in/ft+in
Continuous measurement	Yes
MAX/MIN measurement	Yes
Area calculations	Yes
Volume calculations	Yes
Memory	20 records
Buzzer indication	Yes
Pythagorean 1	Yes
Pythagorean 2	Yes
Add/Subtraction	Yes
Auto laser off	After 30 second
Auto power off	After 3 min
Laser Class	Class II
Laser type	650 nm, < 1mW
Operating Temperature	0°C to +40°C(32°F to 104°F)
Storage Temperature	-10 °C to+60°C (14°F to 140°F)
Battery type	Type AAA 2 x 1.5V
Battery life	Up to 5000 time(only for reference)
Dimension	120x50x30mm/ 4.72"x1.97"x1.18"
Weight(not include batteries)	100g
Individual Packing	Double Blister Card



## NT-6570 Laser Distance Measurer

Water Proof / Dust Proof / Rechargeable Li-ion battery / Comply with IP67



NEW

### Features:

- Special design for outdoor use.
- 5M drop protection.
- Water proof, no worry about rain, sea water, humid and dusty environment.
- Multi-measurement : Area, volume, measurement, pythagorean measurement.
- Voice reporting function : Measuring reads report by voice.
- Durable construction sustains up to 1000kg, provides better protection and max user comfort

Specifications	
Display	LCD display ( 4 lines)
Backlight	Yes
Measuring range	0.1-70M
Accuracy	±2mm
Unit selection	m/ft/in/ft+in
MAX/MIN measurement	Yes
Length/Area/Volume measurement	Yes
Memory	20 records
Buzzer indication	Yes
Pythagorean 1	Yes
Pythagorean 2	Yes
Add/Subtraction	Yes
Auto laser off	After 30 second
Auto power off	After 3 min
Laser Class	Class II
Laser type	635 nm, < 1mW
Certificate	IP67
Operating Temperature	0°C to +40°C(32°F to 104°F)
Storage Temperature	-10 °C to +60°C (14°F to 140°F)
Battery type	1200mAh Rechargeable Li-ion battery
Battery life	Up to 20000 time(only for reference)
Dimension	120X54X28mm(4.72"x2.36"x1.10")
Weight(not include batteries)	119g
Individual Packing	Color box

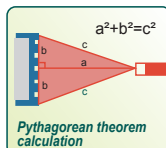
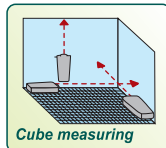
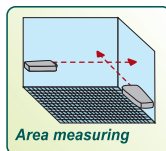

70M  
measurement



## NT-6580 Laser Distance Measurer

Water Resistant, Dust Resistant / Rechargeable Li-ion Battery



NEW

### Features:

- Integrated multi-measuring functions : Features Area, Volume, Tilt and Pythagorean measurement allows easy measuring in any different applications.
- Calculator function : Built-in keypad, easy to use as a calculator.
- Double Injection : Provides better protection and max. user comfort.
- Built-In level function : With vertical & horizontal level sensor for angle measurement and ensures measurement accurately.

Specifications	
Display	LCD display ( 4 lines)
Backlight	Yes
Measuring range	0.2-80M
Accuracy	±2mm
Unit selection	m/ft/in/ft+in
MAX/MIN measurement	Yes
Length/Area/Volume measurement	Yes
Memory	20 records
Buzzer indication	Yes
Tilt measurement	± 180°(360°)± 0.3° accuracy
Pythagorean 1	Yes
Pythagorean 2	Yes
Add/Subtraction	Yes
Calculator	Yes
Auto laser off	After 30 second
Auto power off	After 3 min
Laser Class	Class II
Laser type	635 nm, < 1mW
Certificate	IP54
Operating Temperature	0°C to +40°C(32°F to 104°F)
Storage Temperature	-10 °C to +60°C (14°F to 140°F)
Battery type	1200mAh Rechargeable Li-ion battery
Battery life	Up to 20000 time(only for reference)
Dimension	120x60x28mm(4.72"x2.13"x1.10")
Weight(not include batteries)	122g
Individual Packing	Color box



80M  
measurement

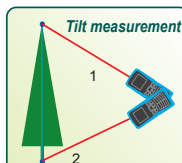
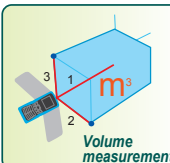
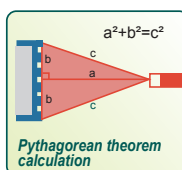
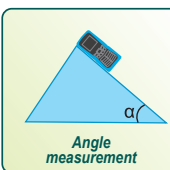

## ▶ NT-311 Digital Temperature Humidity Meter



For Home,warehouse, Internet server center and more

### Features:

- Large LCD display, easy to read
- Integrating Temperature, Humidity, Clock, Alarm clock & Calendar Multi-functions.
- MAX. and MIN. temperature and humidity memory function
- 12-hour/24-hour displaying system selection.
- Wall hanging or desk-top stand support.

Specification	
Temperature range	-10 ~ +55°C / 14 ~ 130°F
Humidity range	10%RH-99%RH
Accuracy	0 ~ 50°C : ±1°C ; otherwise : ±2°C 32 ~ 112°F : ±1.8°F 40% ~ 80%RH : ±8%RH
Resolution	Temperature : 0.1°C (0.2°F) Humidity : 1%RH
Storage condition	-20~60°C (20%RH ~ 80%RH)
Power source	AAA(1.5V) x 1pcs (Not included)
Size	100 x 108 x 20 mm / 3.9"x4.3"x0.8"
Individual packing	Blister card

## ▶ NT-6352 3 in 1 Metal Voltage Stud Detector



CE **Fast, accurate, easy to use,  
LED & buzzer indicators**



### Features:

- Combined unit to accurately detect live or dead electricity cables, water or gas pipes and wooden studs or battens
- LED & buzzer indicators
- Depth penetration 18~20mm ( 0.7 to 0.8 inches)
- Uses precision screwdriver for easy unit sensitivity adjustment
- Power source: NEDA1604/6F22 (9V) x 1pcs(Not included)
- Size: 178 x 120 x 34.7mm ( 7 x 4.8 x 1.4 inches)

Individual packing: Color box



Wooden stud detection

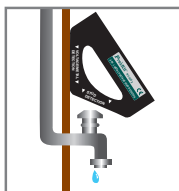

Metal detection

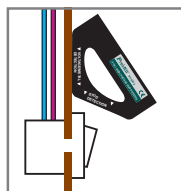

Wiring detection

## ▶ NT-312 Digital Temperature Humidity Meter With Probe



For Home,office use,indoor& outdoor measuring

### Features:

- Economical way to monitor ambient temperature and humidity as well as outdoor temperature via remote temperature probe.
- Large LCD display, easy to read.
- MAX. and MIN. temperature and humidity memory automatic update functions.
- Wall hanging or desk-top stand support.

Specification	
Temperature range	-10 ~ +55°C / 14 ~ 130°F
Humidity range	20% RH ~ 99%RH
Accuracy	0 ~ 50°C : ±1°C, otherwise : ±2°C 40% ~ 80%RH : ±8%RH
Resolution	Temperature :0.1°C Humidity 1%
Probe wired length	2.9 Meters
Ambient temperature	-10 ~ +50°C / +14 ~ 122°F
Power source	AAA(1.5V) x 1pcs (Not included)
Size	75x60x23 mm / 3.0"x2.4"x0.9"
Individual packing	Blister card

## ▶ NT-306 Non-Contact Voltage Detector



**Warning:**  
• Never test voltage more than 1000 VAC  
• Test voltage range: 90V~1000 VAC

### Features:

- Built-in white LED illumination light provides convenient work in dark areas
- Compact size with pocket clip easily fits into pockets or tool pouches
- Red LED and audible alarm if voltage is present
- Entire outer surface is non-conductive for safety, helps avoid high voltage shock
- Powered by two 1.5V AAA batteries (not included)
- CAT IV 1000V Safety rating.
- Applications: Electricians, maintenance staffs, service and safety personnel, and even homeowners
- Detects AC voltage from 90 to 1000 VAC without metallic contact

Individual packing: Blister card



Red LED and audible alarm if voltage is present



Built-in white LED illumination light



Detects AC voltage from 90 to 1000 VAC

## MT-9906/MT-9907 Test Leads

### CE CAT III 1000V

#### Features:

- One pair (one red, one black) comfort grip probes with protective cap for user comfort and safety
- Durable quality PVC insulated test leads with right-angle shrouded banana plugs
- Banana plugs are molded directly to the wire for superior pull strength
- Needle tip test probe, allowing easy access of hard to reach test points
- Compatible with most of multimeters that accept safety style sheath banana plugs

MT-9906 Specification	
Probe	Ø2x17mm
Hand piece	129mm
Lead length	900mm
Plug	Ø4.2x15mm
OAL	1045mm/41.1"
Weight	78.5g

MT-9907 Specification	
Probe	Ø2x17mm
Hand piece	109mm
Lead length	900mm
Plug	Ø4.2x15mm
OAL	1025mm/40.4"
Weight	74g

Individual packing: Blister card

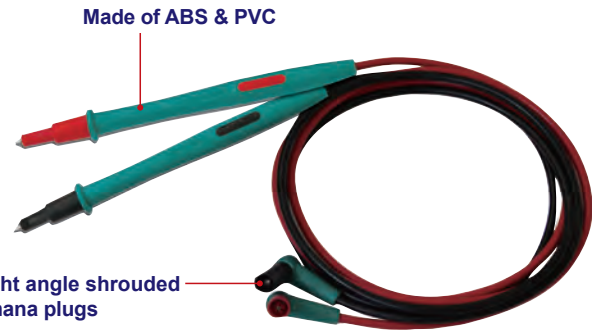

## 400-029/400-030 Receptacle Testers



#### Features:

- Tests for correct wiring, open ground, reverse polarity, open hot, open neutral, hot on neutral, hot and ground reversed with open hot and ground fault interruption in 3-wire, 120VAC circuits
- Model 400-030 features proper operation GFI receptacles testing.

Individual packing: Blister card



400-029



400-030

**Light pattern indicates condition of wiring.**

● Red is on ● Amber is on ○ Light is off

<p><b>OPEN GROUND</b></p> <p>○ ● ○ Ground contact not connected</p>	<p><b>OPEN NEUTRAL</b></p> <p>○ ● ○ Neutral contact not connected</p>	<p><b>OPEN HOT</b></p> <p>○ ○ ○ Hot contact not connected</p>
<p><b>HOT/GRD REVERSE</b></p> <p>● ○ ● Hot and ground contacts interchanged</p>	<p><b>OPEN NEUTRAL</b></p> <p>● ● ○ Hot and neutral contacts interchanged</p>	<p><b>CORRECT</b></p> <p>○ ● ● Receptacle is wired correctly</p>

## 6HP-9xxx Series Oscilloscope Probe Kit



#### Features:

- Switchable X1/X10 attenuation with reference switch positions.
- Break-resistant center conductor & wide compensation range.
- Flatter response, sharper leading edges.
- Faster rise time and replaceable cable probe head tip and ground lead.
- Max. input voltage: 600V (DC-peak AC).
- Includes BNC adapter, IC tip, insulating tip & trimming tool.

Individual packing: Pouch bag



Switchable series							
Model No.	Attn.	Readout	Input impedance	Band width	Resetime	Max input V	Compensation range
6HP-9060	x1	No	1MΩ 91PF	6MHz	58ns	300VDC	NA
	x10		10MΩ 18PF	60MHz	5.8ns	600VDC	10-35PF
6HP-9100	x1		1MΩ 56PF	6MHz	58ns	300VDC	NA
	x10		10MΩ 13PF	100MHz	3.5ns	600VDC	10-35PF
6HP-9150	x1		1MΩ 5PF	6MHz	58ns	300VDC	NA
	x10		10MΩ 13PF	150MHz	2.3ns	600VDC	10-35PF
6HP-9250	x1		1MΩ 56PF	6MHz	58ns	300VDC	NA
	x10		10MΩ 13PF	250MHz	1.4ns	600VDC	10-35PF



# PRECISION PLIERS & CUTTERS

# Pro'sKit® Precision Pliers

## Cutting edge shapes:

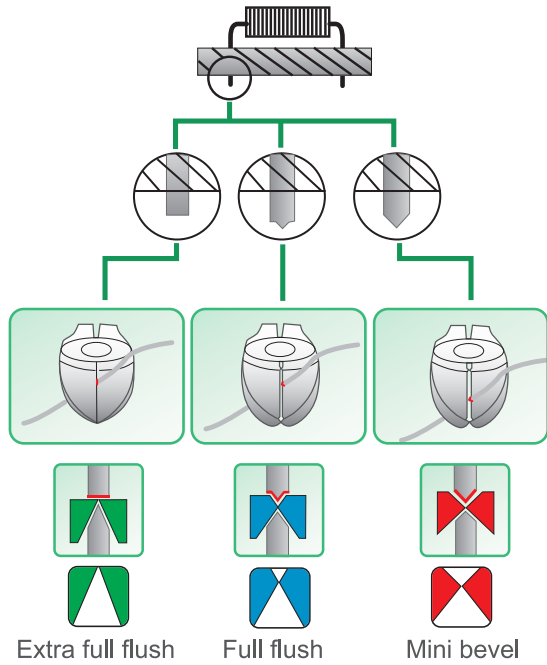

All of Pro'sKit® pliers are made of high quality steel to ensure excellent performance and long life. A variety of materials are used for Pro'sKit® pliers, including: Middle Carbon Steel (S45C, S50C, S55C, SK7, SK5), High Carbon Steel (S60C), High Carbon Tool Steel (SAE 1085), Chrome Vanadium Steel (CrV, SAE 6168, SAE 6150), Chrome-molybdenum Vanadium Steel (SCM 440), Stainless Steel (AISI 420, 410, 420J2, 420K2).

- The overall lengths of most Precision Pliers range from 90 to 145mm (4" to 5-1/2") and are great for use on flattening, bending, holding and cutting precise electronic components, wires and PCB. They are also popular in the jewelry industry.
- The overall lengths of most Electrical Pliers range from 150 to 230mm (6" to 9"), suited for cutting various kinds of heavy duty metal wires, mainly used in electronic, automobile, building field.

## Basic shapes of jaws :

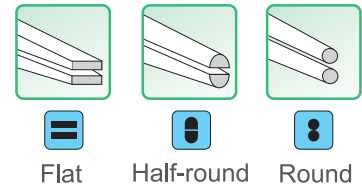

## Gripping surfaces:



## Finish of Pliers:



## Handles:

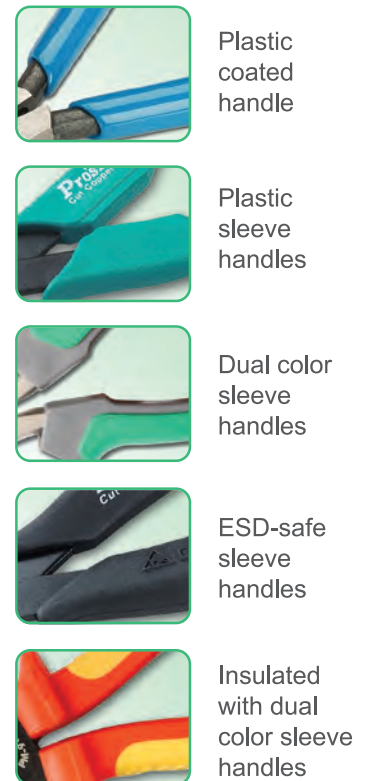

## Spring:

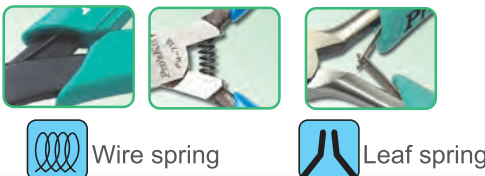

# Pliers Technical Basics

## Spring



**Wire Spring**



**Leaf spring**



Precision pliers with double leaf springs or wire spring to keep the handles always self-opening to supply smooth and efficient operation.

## Gripping surfaces

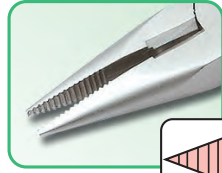

**Serrated**

Serrated jaws provide a good grip but serrations can mar jewelry when you exert force excessively.



**Crosswise serrated**

Crosswise serrated jaws provide the best grip, suited for pulling and cutting various kinds of heavy duty metal wires whatever in horizontal or vertical angles, but serrations will cause abrasion when exerting force too much.

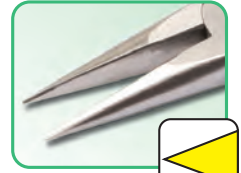

**Smooth**

Smooth jawed pliers are unlikely to mar objects but do not provide good grip. Suited for flattening wire, flattening pins and precision assembly work.

## Shapes of jaws:

- **Flat jaws** : Mainly used in gripping and holding flat or square objects securely and for making angular bends. Insides of jaws may be smooth or serrated. Typically design for electric pliers and electronic flat nose pliers.

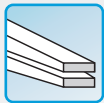

- **Half-round jaws** : Mainly used in holding objects, pulling wires and bending wires. Insides of jaws may be smooth or serrated. It is widely designed in various needle nose pliers.

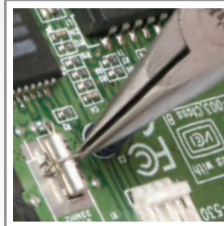
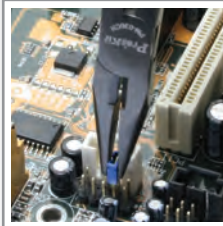
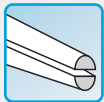

- **Round jaws** : Mainly used in making bends, loops, circles, coils from wire or sheet metal. Tapered circular jaws are smooth so that they will not scratch or nick soft metals. It is popular in the jewelry industry

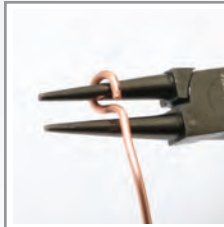
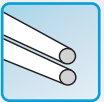

## Cutting edge shapes:



**Without bevel** : This kind of cutting edge shape is usually designed in micro nippers, precision electronic pliers, plastic cutting pliers. Its blades are very sharp, suited for cutting soft wire up to  $\varnothing 1.0\text{mm}$  (AWG 18).



**Small outside bevel** : This kind of cutting edge shape is usually designed in electronic pliers, suited for cutting soft wire, copper wire from 0.6 to  $\varnothing 1.2\text{mm}$  (AWG 22 to 16) or small components.



**Outside bevel** : It is usually designed in electric pliers, needle pliers, suited for cutting thick copper wire or hard iron wire from  $\varnothing 0.8$  to  $\varnothing 1.6\text{mm}$  (AWG 20 to 14) or heavy duty metal pins.

## Safety Caution



- When using cutting pliers, please wear protective goggles and gloves and beware of wire ends flying off.
- Each tool should only be used for its specified purpose.
- Only handles marked with the symbol  1000V are insulating.



### ▶ PM-396G Stainless Long Nose Plier

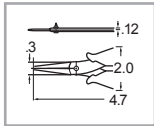

Unit: inch



Material	HRC	OAL. (mm/inch)
AISI 420	43°±3°	120/4.7

### ▶ PM-396H Stainless Flat Nose Plier

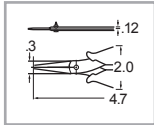

Unit: inch



Material	HRC	OAL. (mm/inch)
AISI 420	43°±3°	120/4.7

### ▶ PM-396I Stainless Bent Nose Plier

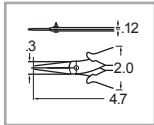

Unit: inch



Material	HRC	OAL. (mm/inch)
AISI 420	43°±3°	120/4.7

### ▶ PM-396F Stainless Cutting Plier

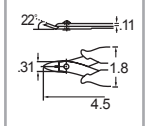

Unit: inch



Material	HRC	Application	OAL. (mm/inch)
		Copper	
AISI 420	48°±3°	Ø 1.3mm/16AWG	115/4.5

### ▶ 200-092 5" Micro Cutter

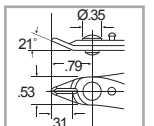

Unit: inch



Material	HRC		Application	OAL. (mm/inch)
	Body	Cutting edge	Copper	
S55C	52°±2'	60°±3'	Ø 1.3mm/16AWG	130/5.1

## Stainless Specialty Electronic Pliers

- Made of AISI420 stainless steel which assures cleanliness and corrosion-resistance.
- Dual color non-slip TPR handles for user comfort.
- Polyoxymethylene (POM) spring for self-opening action to supply smooth operation.



Made of high quality AISI 420 stainless steel



Polyoxymethylene (POM) spring



Individual packing: Blister Card

### ▶ PM-396J Stainless Round Nose Plier

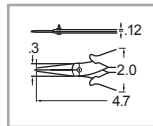

Unit: inch



Material	HRC	OAL. (mm/inch)
AISI 420	43°±3°	120/4.7

### ▶ 100-046 6" Long Nose Plier

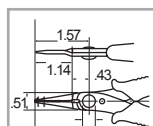

Unit: inch



Material	HRC	OAL. (mm/inch)
S55C	Body 52°±2'	150/5.9

TWEEZERS

PRECISION PLIERS & CUTTERS

ELECTRICAL PLIERS & CUTTERS

KNIVES, SCISSORS & SAWS

CRIMPERS

STRIPPERS

PUNCHDOWN TOOLS

SOLDERING / ASSEMBLY

SCREWDRIVERS/ BITS

HEX KEY/ WRENCHES

SOCKET WRENCHES

TWEEZERS

# Precision Stainless Steel Pliers Mirror Polished

- Made of stainless steel with mirror polished finish
- Leaf springs are spot welded to the tool handles to fix the jaws in a comfortable position
- Forged box joint construction gives strength and precision



Double leaf springs, are easy operation and user comfort

High grade alloy steel, hot drop forged, oil hardened and tempered for long life and perfect precision work

Dipped handle for user comfort



Individual packing: Blister Card

## 200-056 4 1/2" Semi-Flush Diagonal Cutter

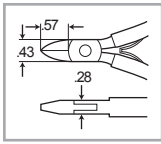

Unit: inch

Material	HRC Body	Application			OAL. (mm/inch)
		Hard steel	Soft steel	Copper	
AISI 420	45°±3°	Ø 0.8mm 20AWG	Ø 1.3mm 16AWG	Ø 2.0mm 12AWG	110/4.3

## 200-057 4 1/2" Full-Flush Diagonal Cutter

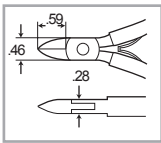

Unit: inch

Material	HRC Body	Application			OAL. (mm/inch)
		Hard steel	Soft steel	Copper	
AISI 420	45°±3°	Ø 0.8mm 20AWG	Ø 1.3mm 16AWG	Ø 2.0mm 12AWG	110/4.3

## 100-011 5" Needle Nose Plier

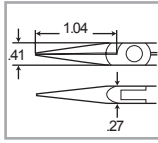

Unit: inch

Material	HRC Body	OAL. (mm/inch)

## 100-013 5 1/2" Needle Nose Plier

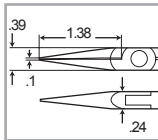

Unit: inch

Material	HRC Body	OAL. (mm/inch)

## 200-058 4 1/2" Slim Full Flush Diagonal Cutter

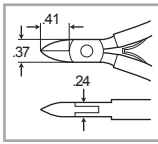

Unit: inch

Material	HRC Body	Application			OAL. (mm/inch)
		Hard steel	Soft steel	Copper	
AISI 420	45°±3°	Ø 0.8mm 20AWG	Ø 1.3mm 16AWG	Ø 1.6mm 14AWG	110/4.3

## 200-059 4 1/2" Full-Flush Straight Side Cutter

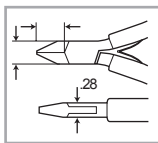

Unit: inch

Material	HRC Body	Application			OAL. (mm/inch)
		Hard steel	Soft steel	Copper	
AISI 420	45°±3°	Ø 0.8mm 20AWG	Ø 1.3mm 16AWG	Ø 2.0mm 12AWG	110/4.3



▶ **100-014 5 1/2" Bent Nose Plier**

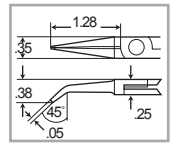

Unit: inch

Material	HRC	OAL. (mm/inch)
	Body	
AISI 420	48 $\pm$ 3*	135/5.3

▶ **100-015 5 1/2" Flat-Nose Plier**

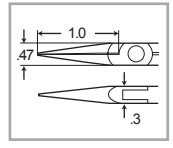

Unit: inch

Material	HRC	OAL. (mm/inch)
	Body	
AISI 420	48 $\pm$ 3*	130/5.1

▶ **200-060 5" Flush Oblique Cutter Slim Tip Plier**

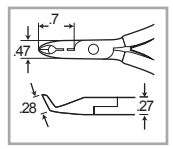

Unit: inch

Material	HRC Body	Application			OAL. (mm/inch)
		Hard steel	Soft steel	Copper	
AISI 420	45 $\pm$ 3*	$\varnothing$ 0.8mm 20AWG	$\varnothing$ 1.0mm 18AWG	$\varnothing$ 1.6mm 14AWG	125/4.9

▶ **100-025 5" Long Nose Plier**

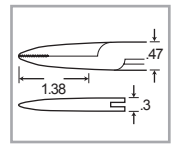

Unit: inch

Material	HRC	OAL. (mm/inch)
	Body	
AISI 420	48 $\pm$ 3*	140/5.5

▶ **100-017 6" Needle Nose Plier**

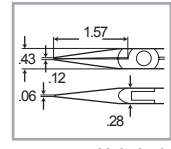

Unit: inch

Material	HRC	OAL. (mm/inch)
	Body	
AISI 420	48 $\pm$ 3*	145/5.7

▶ **100-012 6" Needle Nose Plier**

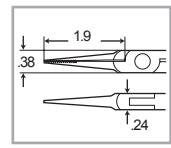

Unit: inch

Material	HRC	OAL. (mm/inch)
	Body	
AISI 420	48 $\pm$ 3*	140/5.5

▶ **100-006 7 1/2" Long Nose Flat Blade Plier**

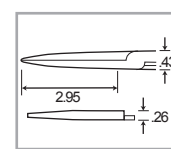

Unit: inch

Material	HRC	OAL. (mm/inch)
	Body	
AISI 420	48 $\pm$ 3*	185/7.3

▶ **200-067 5" Side Cutting Plier**

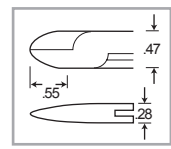

Unit: inch

Material	HRC Body	Application			OAL. (mm/inch)
		Hard steel	Soft steel	Copper	
AISI 420	48 $\pm$ 3*	$\varnothing$ 0.8mm 20AWG	$\varnothing$ 1.6mm 14AWG	$\varnothing$ 2.0mm 12AWG	125/4.9

## Precision Pliers

- High quality carbon steel S45C forged, hardened, finished with nickel plating for corrosion resistance.
- Spring-loaded for self-opening action to reduce fatigue during long term operation.
- Dual color, non-slip TPR handles for user comfort.
- Particularly designed for electronic and precision field.

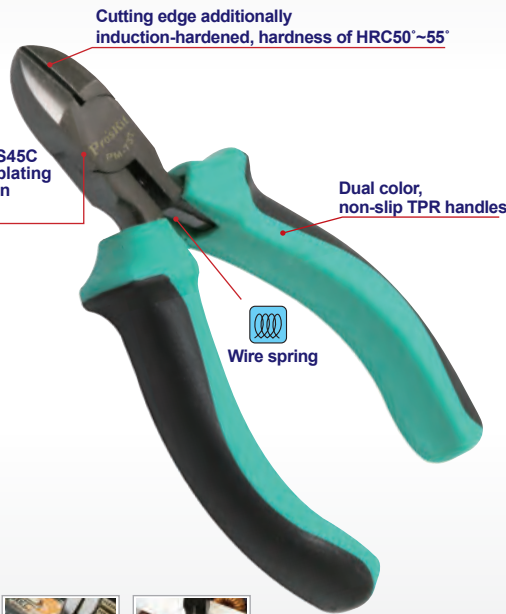

Individual packing: Blister Card

## ▶ PM-731 Mini Lineman's Plier

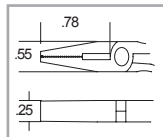

Unit: inch

Material	HRC	Application	OAL.
	Cutting edge	Copper	(mm/inch)
S45C	50~55°	Ø 1.0mm	120/4.7

## ▶ PM-736 Long Nose Plier

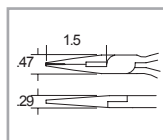

Unit: inch

Material	HRC	Application	OAL.
	Cutting edge	Copper	(mm/inch)
S45C	50~55°	Ø 1.0mm/18AWG	135/5.3

## ▶ PM-754 Flat Nose Plier

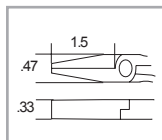

Unit: inch

Material	HRC	OAL.
	Cutting edge	(mm/inch)
S45C	50~55°	138/5.4

## ▶ PM-755 Bent Nose Plier

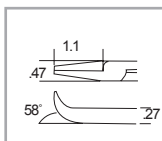

Unit: inch

Material	HRC	OAL.
	Cutting edge	(mm/inch)
S45C	50~55°	135/5.3

## ▶ PM-737 Diagonal Cutting Plier

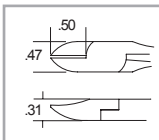

Unit: inch

Material	HRC	Application	OAL.
	Cutting edge	Copper	(mm/inch)
S45C	50~55°	Ø 1.0mm/18AWG	115/4.5

## ▶ PM-746 Needle Nose Plier

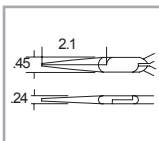

Unit: inch

Material	HRC	OAL.
	Cutting edge	(mm/inch)
S45C	50~55°	150/5.9

### ▶ 100-042 6" Needle-Nose Plier

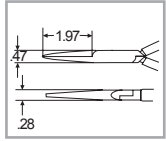
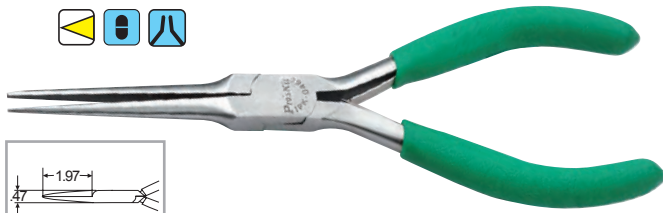

Unit: inch

Material	HRC		OAL. (mm/inch)
	Body		
S45C	43±3*		150/5.9

### ▶ 100-044 5" Flat-Nose Plier

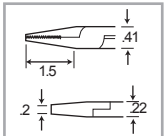

Unit: inch

Material	HRC		OAL. (mm/inch)
	Body		
S45C	43±3*		135/5.3

### ▶ 100-004 5" Bent-Nose Plier

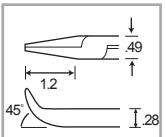

Unit: inch

Material	HRC		OAL. (mm/inch)
	Body		
S45C	43±3*		130/5.1

### ▶ 200-037 4 1/2" Diagonal Cutter Plier

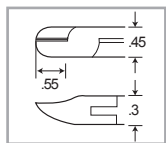

Unit: inch



Material	HRC		Application			OAL. (mm/inch)
	Body	Cutting edge	Hard steel	Soft steel	Copper	
S45C	43±3*	48±3*	Ø 0.8mm 20AWG	Ø 1.3mm 16AWG	Ø 1.6mm 14AWG	110/4.3

### ▶ 200-087 5" Heavy Duty Cutter

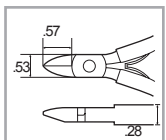

Unit: inch



Material	HRC		Application Hard steel	OAL. (mm/inch)	Individual packing
	Body	Cutting edge			
SAE 6140	45±3*	62±3*	Piano wire: Ø0.5mm (under HRC: 45°)	125/4.9	Blister Card

## Non-Slip Handles Precision Pliers

- Clean and smooth cutting
- Lightweight design for easy operation
- Particularly designed for electronic and precision field

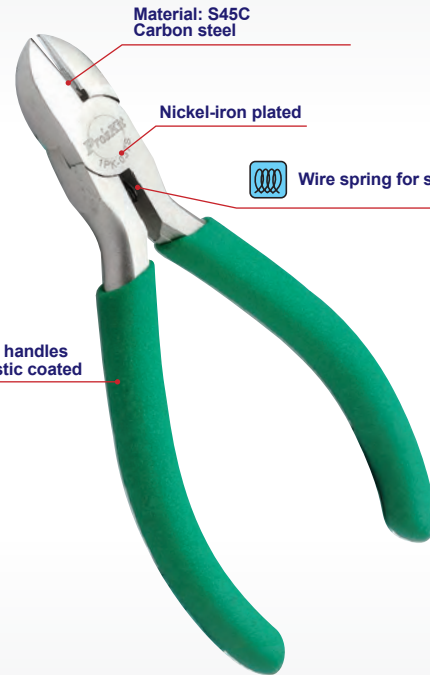

Individual packing:  
Blister Card

### ▶ 100-003 5" Needle-Nose Plier

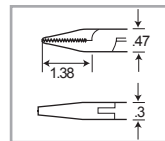

Unit: inch



Material	HRC		Application		OAL. (mm/inch)
	Body	Cutting edge	Hard steel	Copper	
S45C	43±3*	48±3*	Ø 0.8mm 20AWG	Ø 1.6mm 14AWG	136/5.4

### ▶ 100-040 5 1/2" Long Nose Plier

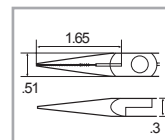

Unit: inch



Material	HRC		Application Hard steel	OAL. (mm/inch)	Individual packing
	Body	Cutting edge			
SAE 6140	45±3*	62±3*	Piano wire: Ø1.2mm (under HRC: 45°)	140/5.5	Blister Card

## Precision Pliers with Adjustable Screw

- Adjustable screw insures precise cuts every time.
- Made of high-quality 63CRM material, precise and durable
- Ergonomic, non-slip handle with dual colors ensures great operator comfort
- Leaf spring, energy saving design for efficient work



Smooth surface is cut (By PM-721/PM-723)



Adjustable screw (By PM-720/PM-721/PM-723)

Individual packing: Blister Card

## PM-721 Diagonal Flush Cutting Nipper

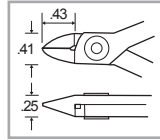

Unit: inch

Material	HRC	Application	OAL.
	Body	Copper	(mm/inch)
63CRM	55 ±3°	Ø 1.3mm/16AWG	115/4.5

## PM-723 Diagonal Flush Cutting Nipper

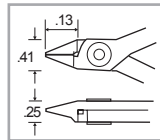

Unit: inch

Material	HRC	Application	OAL.
	Body	Copper	(mm/inch)
63CRM	55 ±3°	Ø 1.3mm/16AWG	115/4.5

## PM-727 Cutting Plier

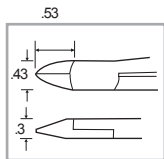

Unit: inch

Material	HRC	Application	OAL.
	Body	Copper	(mm/inch)
SAE 6050	40 ±3°	Ø 1.3mm/16AWG	130/5.1

## PM-728 Cutting Plier

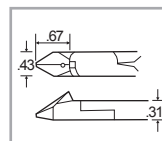

Unit: inch

Material	HRC	Application	OAL.
	Body	Copper	(mm/inch)
SAE 6050	40 ±3°	Ø 1.3mm/16AWG	130/5.1

## 902-078 4 1/2" Precision Cutting Plier

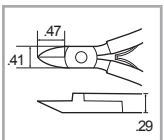
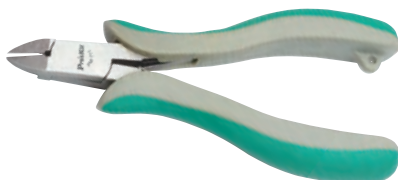

Unit: inch

Material	HRC		Application	OAL.
	Body	Cutting edge	Copper	(mm/inch)
AISI 6140	45 ±3°	61 ±3°	Ø 2.0mm/12AWG	120/4.7

## 902-079 5" Extra Long Nose Plier

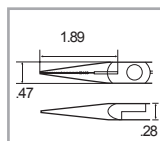

Unit: inch

Material	HRC		Application		OAL.
	Body	Cutting edge	Hard steel	Copper	(mm/inch)
AISI 6140	45 ±3°	61 ±3°	Ø 0.8mm/20AWG	Ø 2.0mm	155/6.1

## ▶ PM-023CN 4 1/2" Pointed Diagonal Plier



Material	HRC		Application			OAL. (mm/inch)
	Body	Cutting edge	Hard steel	Soft steel	Copper	
S45C	43 $\pm$ 2°	52 $\pm$ 2°	Ø 0.8mm 20AWG	Ø 1.3mm 16AWG	Ø 1.6mm 14AWG	115/4.5

## ▶ PM-036CN 5" Snipe Nose Plier

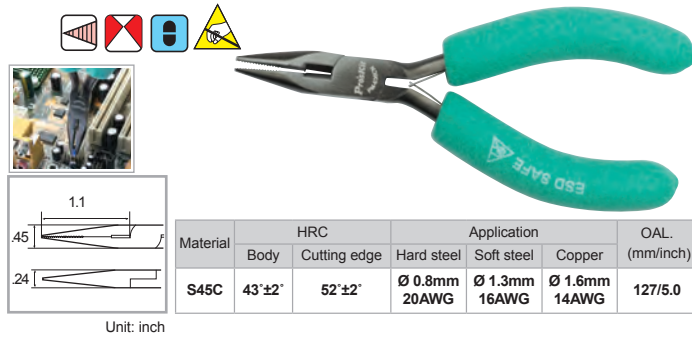

Material	HRC		Application			OAL. (mm/inch)
	Body	Cutting edge	Hard steel	Soft steel	Copper	
S45C	43 $\pm$ 2°	52 $\pm$ 2°	Ø 0.8mm 20AWG	Ø 1.3mm 16AWG	Ø 1.6mm 14AWG	127/5.0

## ▶ PM-029CN 5" Round Nose Plier

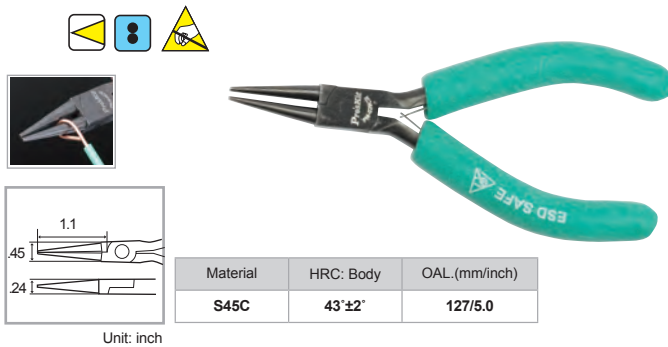

Material	HRC: Body	OAL. (mm/inch)
S45C	43 $\pm$ 2°	127/5.0

## ▶ PM-055CN 5" Bent Nose Plier

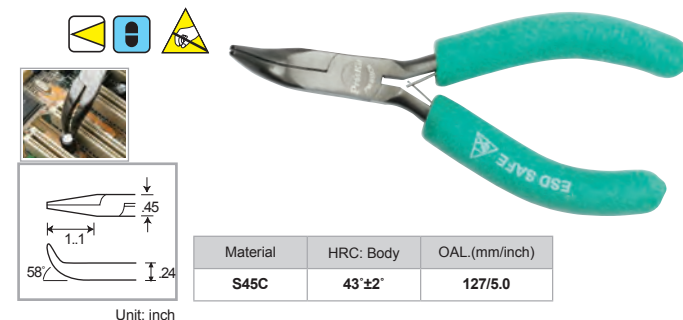

Material	HRC: Body	OAL. (mm/inch)
S45C	43 $\pm$ 2°	127/5.0

## ESD Safe Pliers and Cutters

- Made of high-quality carbon steel with nickel plating
- ESD safe, soft touch cushioned handle provides a secure hold and comfort.
- With double leaf springs for self-opening action
- Individual packing: Blister card

## ▶ PK-ST902 4 Pc Ergonomic ESD Safe Plier And Cutter Kit



Contents
PM-055CN /PM-023CN/PM-037CN/PM-036CN

## ▶ PM-037CN 4 1/2" Diagonal Cutting Plier

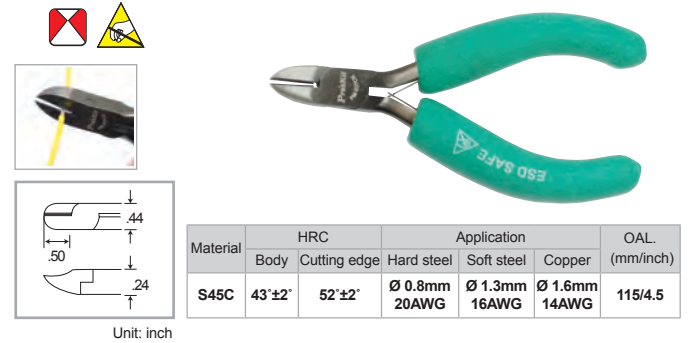

Material	HRC		Application			OAL. (mm/inch)
	Body	Cutting edge	Hard steel	Soft steel	Copper	
S45C	43 $\pm$ 2°	52 $\pm$ 2°	Ø 0.8mm 20AWG	Ø 1.3mm 16AWG	Ø 1.6mm 14AWG	115/4.5

## ▶ PM-046CN 6" Needle Nose Plier

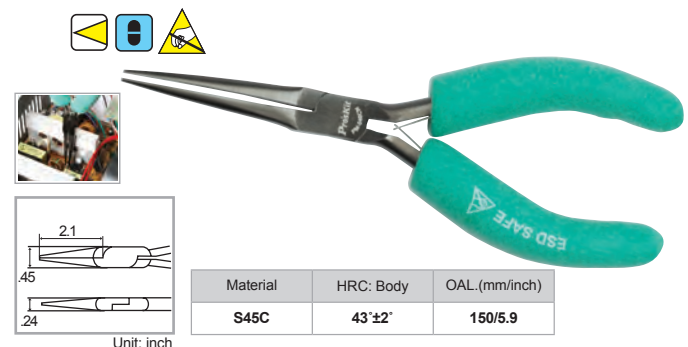

Material	HRC: Body	OAL. (mm/inch)
S45C	43 $\pm$ 2°	150/5.9

## ▶ PM-053CN 5" Flat Nose Plier

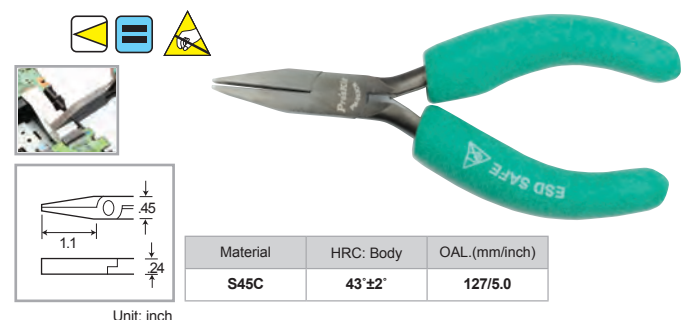

Material	HRC: Body	OAL. (mm/inch)
S45C	43 $\pm$ 2°	127/5.0

TWEEZERS

PRECISION PLIERS & CUTTERS

ELECTRICAL PLIERS & CUTTERS

KNIVES, SCISSORS & SAWS

CRIMPERS

STRIPPERS

PUNCHDOWN TOOLS

SOLDERING / ASSEMBLY

SCREWDRIVERS/ BITS

HEX KEY/ WRENCHES

SOCKET WRENCHES

TWEEZERS

# Specialty Electronic Pliers Conductive Handle

- Made from high carbon steel. Accurately machined, these high quality precision tools are designed for fine assembling and adjustment operations on electronic circuits.
- Provide easy work on high density PC board
- Conductive handle



Cutting edge: HRC 50 $\pm$ 3'

Material: SK7  
High carbon steel  
Hardness: HRC 50 $\pm$ 3'



Individual packing:  
Blister Card



## ▶ 100-007 5" ESD Safe Plier

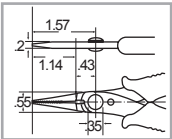

Unit: inch

Material	HRC		OAL. (mm/inch)
	Body	Cutting edge	
S50C	50 $\pm$ 3'	140/5.5	

## ▶ 200-040 5" ESD Safe Micro Cutter

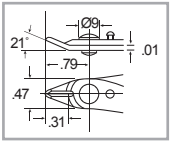

Unit: inch

Material	HRC		Application Copper	OAL. (mm/inch)
	Body	Cutting edge		
SK7	50 $\pm$ 3'	50 $\pm$ 3'	$\varnothing$ 1.3mm 16AWG	130/5.1

## ▶ 200-083 5" ESD SafeClean Cut Micro Nipper

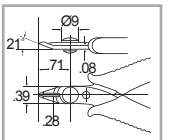

Unit: inch

Material	HRC		Application Copper	OAL. (mm/inch)
	Body	Cutting edge		
SK7	50 $\pm$ 3'	50 $\pm$ 3'	$\varnothing$ 0.8mm 20AWG	120/4.7

## ▶ 5" ESD Safe Cutter

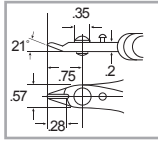

Unit: inch



200-041

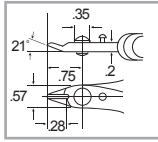

Unit: inch



200-082  
with safety clip



Safety clip design prevents flying leads, good for PC board lead trimming, or any soldered wire leads cutting to ensure user's safety.

Model No.	Material	HRC		Application Copper	OAL. (mm/inch)
		Body	Cutting edge		
200-041	S50C	50 $\pm$ 3'	50 $\pm$ 3'	$\varnothing$ 2.0mm 12AWG	125/4.9
200-082					

## ▶ PM-251 Cutting Plier

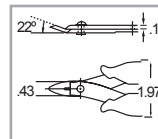

Unit: inch

Material	HRC		Application Copper	OAL. (mm/inch)
	Body	Cutting edge		
AISI 420J2	48 $\pm$ 3'		$\varnothing$ 1.3mm 16AWG	122/4.8

## ▶ PM-252 Bent Nose Plier

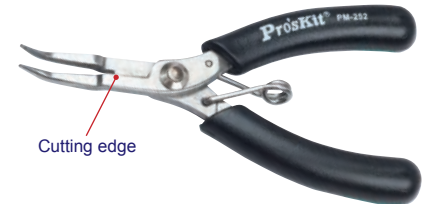

Cutting edge

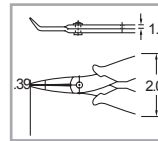

Unit: inch

Material	HRC		Application Copper	OAL. (mm/inch)
	Body	Cutting edge		
AISI 420J2	43 $\sim$ 46'		$\varnothing$ 1.0mm 18AWG	118/4.6

## ▶ PM-254 Long Nose Plier

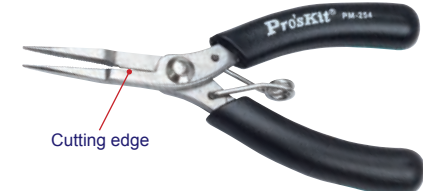

Cutting edge

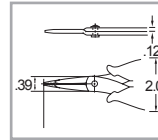

Unit: inch

Material	HRC		Application Copper	OAL. (mm/inch)
	Body	Cutting edge		
AISI 420J2	43 $\sim$ 46'		$\varnothing$ 1.0mm 18AWG	118/4.6

▶ **200-002 5" Economy Flush Cutter**

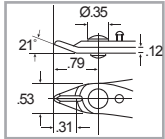

Unit: inch

Material	HRC		Application		OAL. (mm/inch)
	Body	Cutting edge	Copper		
SK7	50±3°	50±3°	Ø 1.6mm 14AWG		125/4.9

▶ **200-071 5" Precision Flush Cutter**

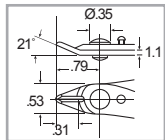

Unit: inch

Material	HRC		Application		OAL. (mm/inch)
	Body	Cutting edge	Copper		
SK7	50±3°	50±3°	Ø 1.3mm 16AWG		130/5.1

▶ **902-077 5" Micro Cutting Plier**

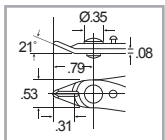

Unit: inch

Material	HRC		Application		OAL. (mm/inch)
	Body	Cutting edge	Copper		
SK5	50±3°	55±3°	Ø 1.6mm 14AWG		130/5.1

▶ **902-011 5" Micro Cutter**

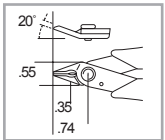

Unit: inch

Material	HRC		Application		OAL. (mm/inch)
	Body	Cutting edge	Copper		
SK5	48±3°	55±3°	Ø 1.2mm 16AWG		125/4.9

▶ **902-075/902-076 5" Micro Cutting Plier**



**902-076 with safety clip**  
Safety clip design prevents flying leads, good for PC board lead trimming, or any soldered wire leads cutting to ensure user's safety.

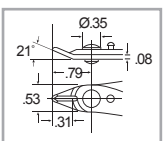

Unit: inch

Model No.	Material	HRC		Application		OAL. (mm/inch)
		Body	Cutting edge	Soft steel	Copper	
902-075	SK5	50±3°	50±3°	Ø 0.8mm 20AWG	Ø 1.6mm 14AWG	130/5.1
902-076						

# Specialty Electronics Pliers

## High quality

- Clean and smooth cutting
- Light for easy operation
- Particularly made for electronic and precision field
- Cut copper wire only

Material: SK7  
High carbon steel  
Hardness: HRC50°



Individual packing: Blister Card

▶ **200-088 5" Micro Cutter**

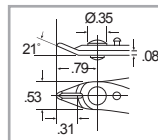

Unit: inch

Material	HRC		Application		OAL. (mm/inch)
	Body	Cutting edge	Soft steel	Copper	
SK5	50±3°	55±3°	Ø 0.8mm 20AWG	Ø 1.6mm 14AWG	130/5.1

▶ **200-080 2 in 1 Wire Stripper/Cutter**



Material	HRC		Application		OAL. (mm/inch)
	Body	Cutting edge	Soft steel	Copper	
AISI 420	48±3°	55±3°	Cutter:Ø1.2mm Stripper:0.4-1.6mm <sup>2</sup> (26-14AWG)		130/5.1

TWEEZERS  
PRECISION PLIERS & CUTTERS  
ELECTRICAL PLIERS & CUTTERS  
KNIVES, SCISSORS & SAWS  
CRIMPERS  
STRIPPERS  
PUNCHDOWN TOOLS  
SOLDERING / ASSEMBLY  
SCREWDRIVERS/ BITS  
HEX KEY/ WRENCHES  
SOCKET WRENCHES  
TWEEZERS



# ELECTRICAL PLIERS & CUTTERS

ELECTRICAL PLIERS & CUTTERS



# Electrical Insulated Tools

**Pro'sKit® Insulated VDE Series** come with high visibility molded ergonomic cushion handles for maximum comfort to ensure full force transfer through the grip. They also have been tested for dielectric strength under 10,000 Volts in a water bath in accordance with DIN EN 60900 (IEC 60900:2004) to encourage the users to trust a reliable insulation when live working up to 1000 Volt.

VDE tools are often used under extreme conditions, such as very low or very high temperature. Pro'sKit Insulation VDE Series are made from high grade materials, which have been tested by low-temperature impact test, high-temperature adhesive power test and burning test to offer more safety to users.

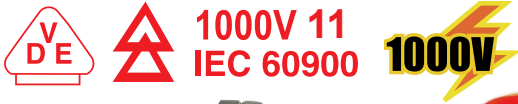

## Safety Caution



- Please keep your insulated tools dry and clean.
- Wear protective goggles and gloves when working.
- Do not touch the non-insulated parts when working live.

## Testing Procedure



### Dielectric Strength Test

Individual immersion test at 10,000 Volt to guarantee safety working up to 1000 Volt.

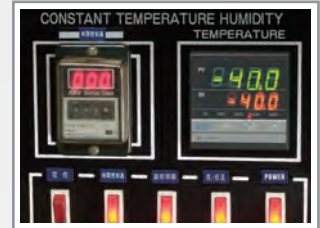

### Low-temperature Impact Test

Cool the tools to -40°C then conduct the impact test. The insulation must retain its toughness and not break.

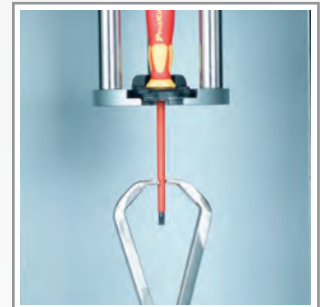
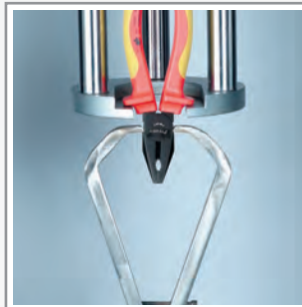
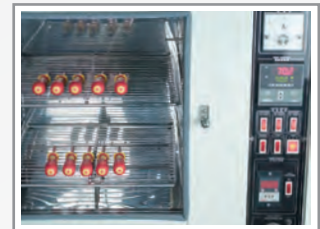

### High-temperature Adhesive Power Test

After storage for 168 hours at 70°C, pull the insulated part with tensile force of 500Nm for 3 minutes. This test ensures that the insulation still stays firm and remain snug against the tool body.



### Burning Behavior Test

Pro'sKit® insulated tools use flame-resistant plastics for insulation to protect users.

# Insulated VDE Pliers



1000V 11  
IEC 60900 : 2004



- Certified to IEC 60900: 2004, VDE, and DIN 1,000V safety standards and bear GS sign.
- High visibility molded ergonomic cushion handle for maximum comfort.
- Hard chrome finish with PTFE coating for anti-rust protection.
- Drop forged from special tool steel.

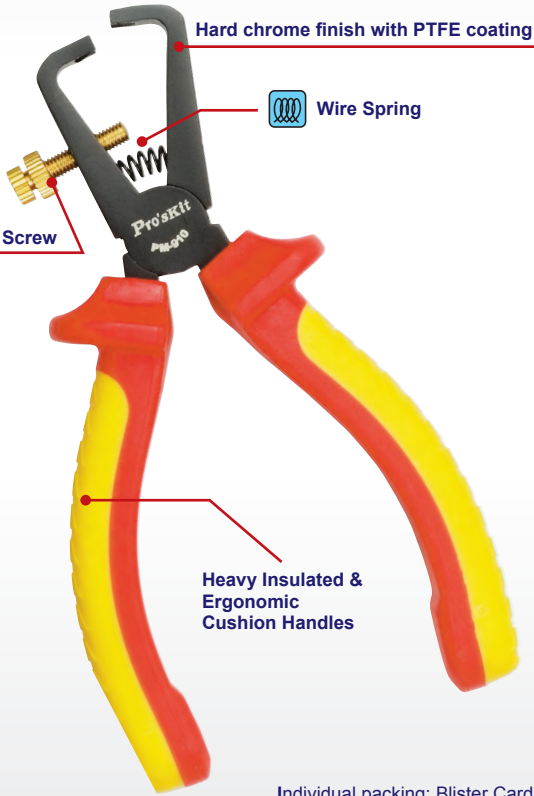

Individual packing: Blister Card

## 902-202 Insulated Wire Stripping Plier



Material	HRC	Application		OAL. (mm/inch)
	Body	Hard steel	Soft steel	
AISI 6150	46 $\pm$ 4 $^{\circ}$	Adjustable to accept conductors up to 10mm $^2$ /8AWG overall diameter		160/6.3

## 902-206 Insulated Side Cutter



Material	HRC	Application		OAL. (mm/inch)
	Body	Hard steel	Soft steel	
AISI 6150	46 $\pm$ 4 $^{\circ}$	$\varnothing$ 2.0mm/12AWG	$\varnothing$ 2.8mm/10AWG	165/6.5

## 902-205 Insulated Heavy Duty Side Cutter



Material	HRC	Application		OAL. (mm/inch)
	Body	Hard steel	Soft steel	
AISI 6150	46 $\pm$ 4 $^{\circ}$	$\varnothing$ 2.7mm/10AWG	$\varnothing$ 3.8mm/8AWG	200/7.9

## 902-203 Insulated Combination Plier



Material	HRC	Application		OAL. (mm/inch)
	Body	Hard steel	Soft steel	
AISI 6150	46 $\pm$ 4 $^{\circ}$	$\varnothing$ 2.5mm/10AWG	$\varnothing$ 3.8mm/8AWG	195/7.7

## 902-204 Insulated Combination Plier



Material	HRC	Application		OAL. (mm/inch)
	Body	Hard steel	Soft steel	
AISI 6150	46 $\pm$ 4 $^{\circ}$	$\varnothing$ 2.0mm/12AWG	$\varnothing$ 3.1mm/8AWG	175/6.9

## 902-207 Insulated Long Nose Plier



Material	HRC	Application		OAL. (mm/inch)
	Body	Hard steel	Soft steel	
AISI 6150	46 $\pm$ 4 $^{\circ}$	$\varnothing$ 2.2mm/12AWG	$\varnothing$ 3.2mm/8AWG	200/7.9

## 902-208 Insulated Long Nose Plier



Material	HRC	Application		OAL. (mm/inch)
	Body	Hard steel	Soft steel	
AISI 6150	46 $\pm$ 4 $^{\circ}$	$\varnothing$ 1.6mm/14AWG	$\varnothing$ 2.5mm/10AWG	170/6.7

### ▶ PM-931 8.5" High Leverage Combination Cutting Plier

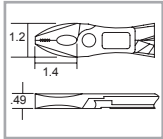

Unit: inch

Material	HRC		Application Hard steel	OAL. (mm/inch)
	Body	Cutting edge		
60Cr-V	46° ± 2°	59° ± 3°	Ø2.2mm/12AWG (HRC40° ~ 43°)	215.5/8.5

### ▶ PM-934 7.5" High Leverage End Cutting Plier

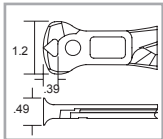

Unit: inch

Material	HRC		Application Hard steel	OAL. (mm/inch)
	Body	Cutting edge		
60Cr-V	46° ± 2°	59° ± 3°	Ø2.0mm/12AWG (HRC40° ~ 43°)	189/7.4

### ▶ PM-936 8" High Leverage Diagonal Cutting Plier

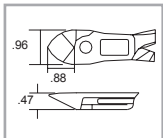

Unit: inch

Material	HRC		Application Hard steel	OAL. (mm/inch)
	Body	Cutting edge		
60Cr-V	46° ± 2°	59° ± 3°	Ø2.0mm/12AWG (HRC40° ~ 43°)	201.5/7.9

### ▶ PM-938 8" High Leverage Long Nose Plier

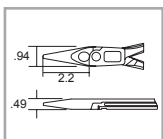

Unit: inch

Material	HRC		Application Hard steel	OAL. (mm/inch)
	Body	Cutting edge		
60Cr-V	46° ± 2°	59° ± 3°	Ø2.0mm/12AWG (HRC40° ~ 43°)	207/8.2

## High Leverage Pliers



- New mechanical design, up to 50% cutting force saving than regular pliers.
- Induction-hardened cutting edge stay sharp for a long service life, hardness approx. HRC56°~62°.
- Hot-riveted joint ensures smooth action and no handle wobble.
- Made from Cr-V steel with nickel plating for corrosion resistance.
- Ergonomically shaped non-slip TPR handle for user comfort.

Material: 60Cr-V  
Cutting edge: HRC56°~62°



PM-93 series Cutting force comparison graph

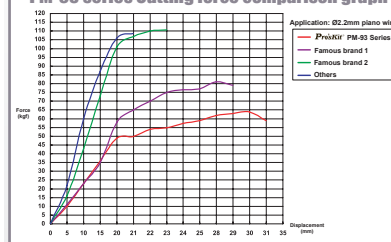

Individual packing: Blister Card

### ▶ PM-937 7" High Leverage Diagonal Cutting Plier

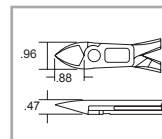

Unit: inch

Material	HRC		Application Hard steel	OAL. (mm/inch)
	Body	Cutting edge		
60Cr-V	46° ± 2°	59° ± 3°	Ø2.0mm/12AWG (HRC40° ~ 43°)	177/7.0

# Tungsten Steel Pliers & Cutters

**5 times longer lifetime**  
than traditional pliers  
**Cost saving**

- Tungsten steel cutting edge, hardness of HRC up to 72°±2° providing high durability, long service life and anti-rust.
  - High leverage powerful diagonal cutter
  - High quality PVC handle will not easily come off
- Individual packing: Blister Card

## PM-923 Tungsten Diagonal Cutting Plier



Material: SAE 6140 & tungsten double alloy steel  
Hardness: HRC 45°±3°  
Steel cutting edge hardness: 72°±2°

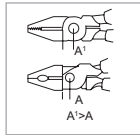

High leverage powerful  
Force saving design

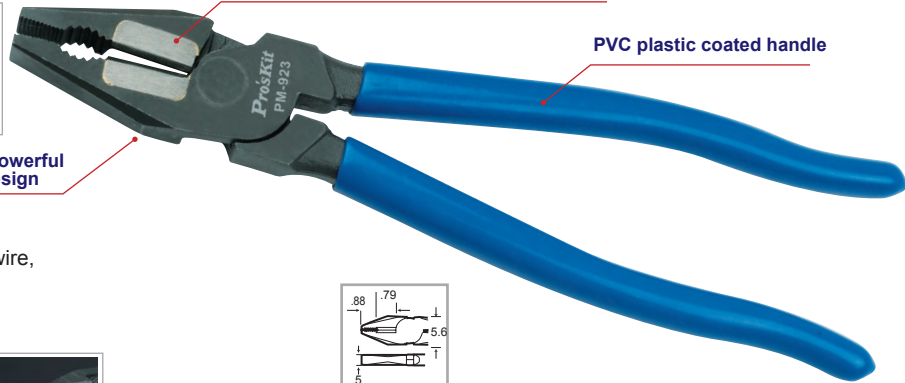

• Cutting capacity: piano wire  $\varnothing 2.5\text{mm}$  (.10") under HRC 50°

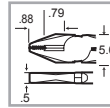

Material	HRC		Application			OAL. (mm/inch)
	Body	Cutting edge	Hard steel	Soft steel	Copper	
SAE 6150 + Tungsten	45°±3°	72°±2°	Piano wire: $\varnothing 2.5\text{mm}$ (under HRC: 50°)	$\varnothing 3.0\text{mm}$ 8AWG	$\varnothing 5.5\text{mm}$ 4AWG	225/8.9

## PM-925 Tungsten Diagonal Cutting Plier

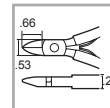

Unit: inch

- Precisely cuts dot matrix printer firing pin, wire spring, piano wire, hard steel components pin (under HRC 50°)
- Spring-loaded for self-opening action to supply smooth operation

Material	HRC		Application			OAL. (mm/inch)
	Body	Cutting edge	Hard steel	Soft steel	Copper	
SAE 6140 + Tungsten	45°±3°	72°±2°	Piano wire: $\varnothing 0.5\text{mm}$ (under HRC: 50°)	$\varnothing 1.6\text{mm}$ 14AWG	$\varnothing 2.0\text{mm}$ 12AWG	125/4.9

## Tungsten Diagonal Cutting Plier



- Precisely cuts dot matrix printer firing pin, wire spring, piano wire, hard steel components pin (under HRC 50°)
- Spring-loaded for self-opening action to supply smooth operation

### PM-955

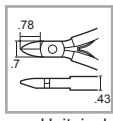

Unit: inch



Material	HRC		Application			OAL. (mm/inch)	
	Body	Handle	Body	Cutting edge	Piano Wire		
SAE 6140 + Tungsten	PVC	45°±3°	72°±2°	$\varnothing 0.5\text{mm}$ under HRC: 50°	$\varnothing 1.6\text{mm}$ 14AWG	$\varnothing 2.0\text{mm}$ 12AWG	130/5.1

### PM-956

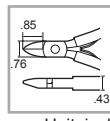
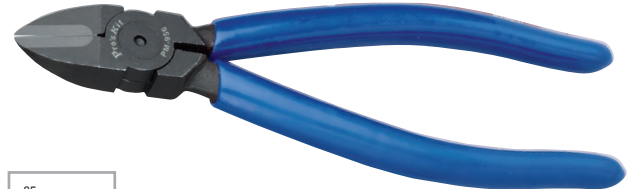

Unit: inch

Material	HRC		Application			OAL. (mm/inch)	
	Body	Handle	Body	Cutting edge	Piano Wire		
SAE 6140 + Tungsten	PVC	45°±3°	72°±2°	$\varnothing 0.5\text{mm}$ under HRC: 50°	$\varnothing 1.6\text{mm}$ 14AWG	$\varnothing 2.0\text{mm}$ 12AWG	160/6.3

## ▶ PM-924 9" Steel Wire Cutting Crimping Plier



Material		HRC		Application	OAL. (mm/inch)
Body	Handle	Body	Cutting edge		
SCM440	TPR	45°±3°	61°±3°	For cutting round cable up to Ø 9.2mm (Ø3/8") and crimping non-insulated terminals with wire 1.25/2.0/5.5/8mm <sup>2</sup> /AWG22-16/16-14/12-10/8	225/8.9

## ▶ 902-307 9.5" Lineman's Plier



Material	HRC	Application		OAL. (mm/inch)
		Hard steel	Soft steel	
Cr-V	45°±3°	Piano wire: Ø2.5mm 10AWG	Ø 3.0mm 8AWG	238/9.5

## ▶ 100-033 6" Slip-Joint Pliers



Plastic coated handle Non-slip

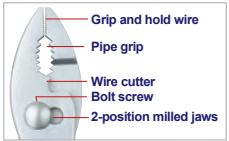
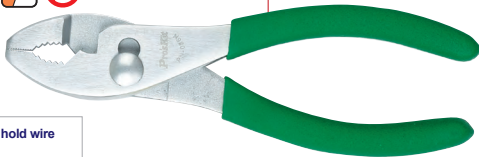

Material	HRC	Handle	OAL. (mm/inch)
S45C	38°±3°	PVC	154/6.1

## ▶ 100-021 Long Nose Plier

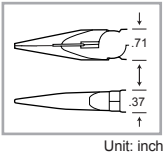

Unit: inch

Material	HRC	Application			OAL. (mm/inch)
		Body	Hard steel	Soft steel	
S60C	48°±3°	Ø1.2mm 16AWG	Ø 2.0mm 12AWG	Ø2.6mm 10AWG	160/6.3

## ▶ 902-049 Plastic Cutting Plier

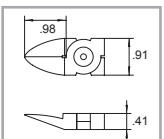

Unit: inch

Material	HRC	Cutting edge	Application	OAL. (mm/inch)
S55C	45°±3°	55°±3°	plastic	185/7.3

⚠ This series of pliers are made for plastic cutting only

## Steel Wire Cutting Crimping Plier

- Made of high quality SCM440 hot-riveted design features smooth, wobble-free operation.
- The high-leverage design provides greater cutting and gripping power
- Special design for cutting round cable with multi-conductor up to Ø3/8"



PM-924

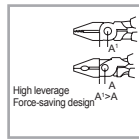

Unit: inch

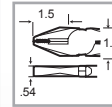

Unit: inch

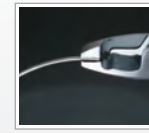

Serrated jaw for gripping



Crimping non-insulated terminals

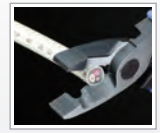

Cutting up to Ø3/8"

Individual packing: Blister Card

## ▶ 200-038 6" Diagonal Cutter

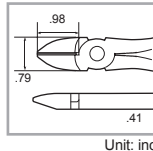

Unit: inch

Material	HRC	Application			OAL. (mm/inch)
		Body	Hard steel	Soft steel	
S60C	48°±3°	Ø1.2mm 16AWG	Ø 2.0mm 12AWG	Ø2.6mm 10AWG	160/6.3

## ▶ 902-246 8" Diagonal Cutter

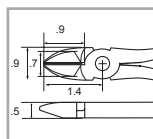

Unit: inch

Material	HRC	Cutting edge	Application			OAL. (mm/inch)
			Body	Hard steel	Soft steel	
S55C	40°~50°	55°±3°	Ø0.8mm 20AWG	Ø 2.0mm 12AWG	Ø2.6mm 10AWG	200/7.9

TWEEZERS  
PRECISION PLIERS  
ELECTRICAL PLIERS & CUTTERS  
KNIVES, SCISSORS & SAWS  
GRIMPERS  
STRIPPERS  
PUNCHDOWN TOOLS  
SOLDERING / ASSEMBLY  
SCREWDRIVERS/ BITS  
HEX KEY/ WRENCHES  
SOCKET WRENCHES  
TWEEZERS

### ▶ 100-039 Multi-Crimp Tool

- Wire cutter in nose
- Plastic-coated handle
- For crimping non-insulated terminals from 10 to 22 AWG

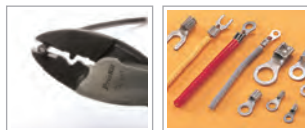

Material	Handle	HRC Body	Application		OAL. (mm/inch)
			Hard steel	Crimping	
S60C	PVC	42°±3°	Ø1.6mm 14AWG	Non-insulated terminal 10 ~ 22 AWG	248/9.8

Individual packing: Blister Card

### ▶ 200-063 Wire Rope and Armored Cable Cutter

- Special cutting action for cutting wire strand cable armour, electric cable, metal wire and rods.
- Distortion free cut
- Spring loaded handle



Material	Handle	HRC Cutting edge	Application	OAL. (mm/inch)
S55C+PVC	SK5	55°±3°	Cutting: Ø4mm/6AWG (Copper) Wire rope: Ø1.5mm/14AWG spring wire	190/7.5

Individual packing: Blister Card

### ▶ 100-022 Snap Ring Plier Set

- 3 convertible tip jaws can be changed easily for 6 different internal-external purposes.

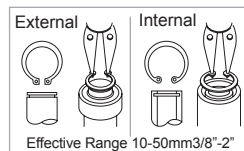

Material	Handle	HRC Body	Application		OAL. (mm/inch)
			Hard steel	Effective range: 10~50mm (3/8"-2")	
S45C	PVC	43°±3°			155/6.1

Individual packing: Blister Card

### ▶ 300-151 Strain Relief Bushing Assembly Tool



- Designed to install all sizes of strain relief bushing
- Close lock and return spring function



Material	Handle	Hardness Body	Application	OAL. (mm/inch)

Individual packing: Blister Card

### ▶ SR-008 PVC Pipe Cutter (Economy type)

- Ideal for cutting PVC, Aluminum or plastic pipes



Material	Handle	HRC Cutting edge	Application		OAL. (mm/inch)
			Body	Blade	
Aluminum alloy	3Cr13	53°±3°	Product characteristics: cuts PVC, Aluminum or plastic pipes. Scope of cut: rigid plastic pipes to a maximum diameter of 26mm		210/8.3

Individual packing: Blister Card

### ▶ 200-039 Plastic Pipe Cutter



Ratching force-saving design

Material	Handle	Application	Replacement blade	OAL. (mm/inch)
Aluminum alloy	SK5	Ø6~42mm / 1/4"-5/8" OD. plastic pipes	200-045	195/7.7

Individual packing: Blister Card

## ▶ SR-228 Copper Clad Steel Coaxial Cable Cutter



- Body made of high quality S45C with black oxide finish for anti-rust.
- Palm-fit ergonomic cushion grip handle provides user comfort.
- Adjustable screw and nut ensures proper fix and durability
- Safety lock for easy storage



For cutting steel center conductor and keeping cable round



## ▶ 200-015 6 1/2" Round Cable Cutter



- Made of S45C carbon steel
- Safety lock for easy storage
- For cutting Multi-conductor cable up to 0.5" (12.7mm) and Strand wire up to 8 AWG (10mm<sup>2</sup>)



Cutting round cable



Spring



Safety lock



## ▶ 200-046 Round Cable Cutter



- Made of S45C carbon steel
- Safety lock for easy storage
- For cutting Thick wire up to 2/0 (70mm<sup>2</sup>/00AWG) cable, 100 pair group telephone cable size



Spring



Safety lock



Cutting round cable



Model No.	Material	HRC		Handle	Application	OAL. (mm/inch)
		Body	Body			
SR-228	S45C	50°±2°	PVC		RG-6, RG-58, RG-59 copper clad steel coaxial cable max. 16mm <sup>2</sup>	159/6.3
200-015		45°±3	PVC		38mm <sup>2</sup> flexible/3AWG	165/6.5
200-046		45°±3	PVC		16mm <sup>2</sup> solid/4AWG, 35mm <sup>2</sup> stranded/2AWG, 70mm <sup>2</sup> flexible/00AWG	215/8.5

Individual packing: Blister Card

## ▶ 200-068/200-013/200-069 Forged Cable Cutter



- This heavy duty cable cutter has high-leverage jaw with shear-cut blades.
- Do not cut steel or ACSR.
- Plastic coated handle.



Cuts up to 70mm<sup>2</sup>/00AWG aluminum and copper cables (200-069)

200-068



200-013



200-069



Model No.	Material	HRC		Handle	Application		OAL. (mm/inch)
		Body	Cutting edge		Copper cable	Aluminum cable	
200-068	SCM 440	45°±3	60°±5°	PVC	25mm <sup>2</sup> flexible/4AWG	25mm <sup>2</sup> stranded/4AWG	160/6.3
200-013	SCM 440	45°±3	60°±5°	PVC	38mm <sup>2</sup> flexible/3AWG	38mm <sup>2</sup> stranded/3AWG	210/8.3
200-069	S45C	45°±3	60°±5°	PVC	16mm <sup>2</sup> solid/4AWG, 35mm <sup>2</sup> stranded/2AWG, 70mm <sup>2</sup> flexible/00AWG	70mm <sup>2</sup> stranded/00AWG	235/9.3

Individual packing: Blister Card

TWEEZERS  
PRECISION PLIERS  
ELECTRICAL PLIERS & CUTTERS  
KNIVES, SCISSORS & SAWS  
GRIMPERS  
STRIPPERS  
PUNCHDOWN TOOLS  
SOLDERING / ASSEMBLY  
SCREWDRIVERS/ BITS  
HEX KEY/ WRENCHES  
SOCKET WRENCHES  
TWEEZERS

## ▶ SR-538 Ratchet Cable Cutter 750MCM



**New Innovation  
Industrial Grade**

Material: SAE4340  
Cutting edge: HRC 46°±2°

Ratchet release trigger

Handle lock

Material: S45C

Material: PP



Cutting cables up to 750MCM (300mm<sup>2</sup>)

Application	Replacement blade	OAL. (mm/inch)
750MCM(300mm <sup>2</sup> ) Copper and Aluminum cable	5SR-538-RB (Moving blade) 5SR-538-FB (Fixed blade)	335/13.2

⚠ Not designed for cutting steel or ACSR Individual packing: Inner box+ color label

## ▶ 200-006 Ratchet Cable Cutter 500MCM



- Cut Ø32mm(1-1/4") and smaller hard-drawn copper and aluminum cables.
- Case hardened blades improve performance and cutting life.
- Unique ratchet design ensures a non-slip cut, and increases cutting power on tough jobs.
- Cut up to 350 MCM copper 500 MCM Al-jacketed S.O. cord up to Ø1-1/4" (Ø32mm) dia or up to 200 Pair Communication cable.



Material		Hardness		Handle	Application	Replacement blade	OAL. (mm/inch)
Body	Blade	Body	Cutting edge				
Low carbon steel	SAE 4340	HR 30N 55~70	HRC 45°±3°	PVC	Ø32mm copper & Aluminum cable	200-034 (Moving blade) 200-035 (Fixed blade)	254/10

⚠ Not designed for cutting steel or ACSR Individual packing: Blister Card

## ▶ 200-043 24" Heavy Duty Cable Cutter



- SCM4 Chrome-Vanadium-Steel forged, efficient and secure in operation.
- Alloy-Aluminum handle, treated by T6 heat, strong durable and handy.

SCM4 Chromium-Molybdenum steel; efficient and secure in operation

Aluminum handles with non-fracture character

Soft rubber sleeves handle

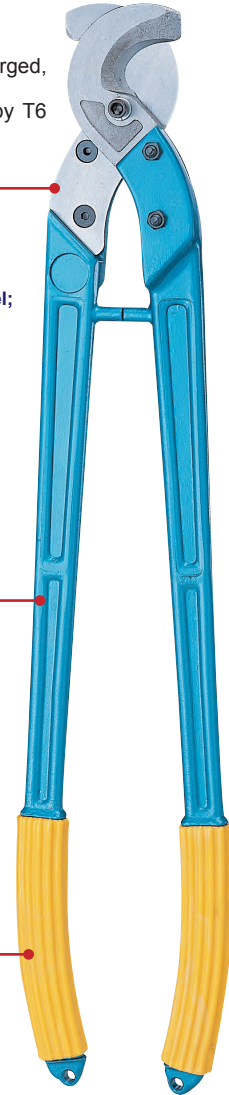

Model No.	Material	HRC	Application	OAL. (mm/inch)	Individual packing
200-043	Blade: SCM4	Blade: 52°±2°	Copper cable: DIN 250mm <sup>2</sup> /500MCM	600/23.6	Inner box + Color label

## ▶ 902-062 Ratchet Cable Cutter



Material:SAE 4340  
Cutting edge: HRC 45°±3°

- Cutter for cutting for cable up to 750MCM
- Quick release knob for easy blade back out
- Handle locks for convenient tool storage
- For copper and Aluminum Cables only not for cutting Steel
- OAL: 210mm/8.3"

Replacement blades	
902-258	902-259



S45C

PP Handle



Individual packing: Inner box + Color label





**KNIVES / SCISSORS & SAWS**

### ▶ 902-318 Utility Knife

- Body is made of durable heavy duty aluminum alloy, corrosion.
- Single screw design for easy blade change.
- Retractable blade with 3 adjustable positions of locking mechanism to prevent injuries.
- Handle with loop design for comfortable use and easy hanging.



Replacement blade: 902-261(100pcs/pack)

Blade locks with 3 positions

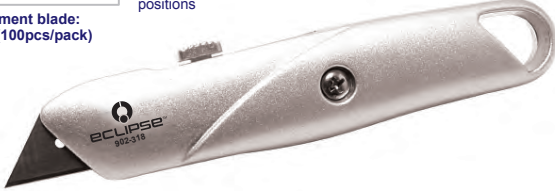

Handle	Blade	OAL.(mm/inch)	Individual packing
Aluminum Alloy	#60 Carbon Steel	155/6.1	Blister card

### ▶ 902-319 Electrician's Knife

- High quality stainless steel blade construction for extra strength and durability
- Both a heavy duty knife for cutting cable easily and for stripping wires encased in a durable composition handle
- Flathead screwdriver blade with self-locking system for safety.
- Rugged bail hangs onto belt clasp for convenient carrying
- Black composition handle with brass liners, non-slip



Handle	Blade	OAL.(mm/inch)	Individual packing
Steel and Nylon	40Cr	95/3.6	Blister card

### ▶ 902-317 Carton Cutter

- All metal made cutter and cover for safe usage, equipped with standard replaceable single-side razor blade
- Reverses to become a scraper
- Lightweight and compact design with easy blade change
- Excellent cutter for cutting corrugated, paper, films, acetates, cardboard, and more



Carton cutter



Scraper



2pcs/pack

Handle	Blade	OAL.(mm/inch)	Individual packing
Stainless Steel	#60 Carbon Steel	101/4	Blister card

### ▶ DK-2112 Auto Loading Utility Knife



Blade storage compartment

- Comfortable ergonomic shaped handle with non-slip TPR grip
- Automatic blade reload for effortless and quick blade changes
- Convenient blade storage compartment holds up to 6pcs blades (blades included)
- Perfect for cutting carpet, cardboard, upholstery, sheetrock and more.
- 10mm < carpet plastic cardboard PVC leather



Handle	Blade	Replacement blade	OAL. (mm/inch)	Individual packing
Zinc Alloy+TPR	SK5	902-261(100pcs/pack)	165/6.5	Blister card

### ▶ PD-998 Electrician's Knife



- High quality stainless steel, large curved hawk bill blade offer durability and artistic appearance
- Ideal for heavy-duty line work



PVC, PE cable stripping



Handle	Blade	OAL. (mm/inch)	Individual packing
ABS	3Cr13	110/4.3	Blister card

### ▶ 900-215 Nibbling Tool

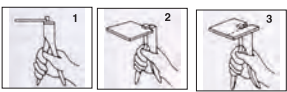

Material to be nibbled shall be placed in the gap between the punch and blade channel.



By squeezing the handle together, the punch will move down into the channel to cut out a slug of metal.



A scribe line can be followed by looking down on work in this position. A slot is cut by making successive cuts.



To make a sharp 90 degrees turn - pull the tool out of the slot. Turn the work 90 degrees and insert the tool again.



By turning the tool before each cut, a minimum radius can be cut.



Almost any size or shape hole can be cut by starting with a 3/8"(9.5mm) hole.



Material	HRC Body	Application	OAL. (mm/inch)	Individual packing
Body:FCD45 Blade:S45C	45±3°	Cut up to 18AWG soft steel, 1/16" copper, Al and Plastic	184/7.2	Blister card

## ▶ PD-395A 30PCS Deluxe Hobby Knife Kit



Contents
3pcs TPR+PP dual color non-slip handles
19pcs SK5 carving blades (3pcs in handle)
2pcs awl blades
4pcs shovel blades
1pcs tweezers
1pcs grind stone
Dual color TPR+PP case (8"x5.2"x1.77")

Individual packing: Blister Card



PCB layout cutting



Solder paste & glue

## ▶ Precision Knife

- Surgically sharp knives with high-impact plastic safety cap.



**900-112** Ø8mm



**900-113** Ø11mm



**900-112B** (10pcs/pack)



**900-113B** (10pcs/pack)



Model No.	Handle	Blade	Replacement blade	OAL. (mm/inch)	Individual packing
900-112	Aluminum	SK-5	900-112B(10pcs/pack)	145/5.7	Blister card
900-113			900-113B(10pcs/pack)	150/5.9	

## ▶ 902-189 Jab Saw

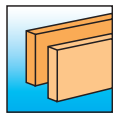
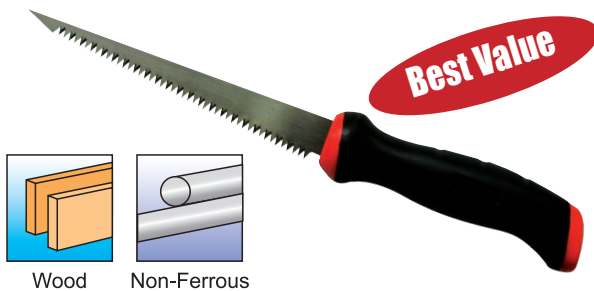

Wood

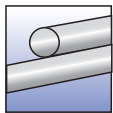

Non-Ferrous

Material		Application	OAL.(mm/inch)	Individual packing
Handle	Blade			
ABS+TPR	65Mn	Wood, plastic and drywall	314/12.5	Blister card

## ▶ 900-135 Cable Splicing Knife

- Short blade for strength
- Stainless-steel blade for durability and longer lasting blade edge
- Soft, easy-to-grip handle

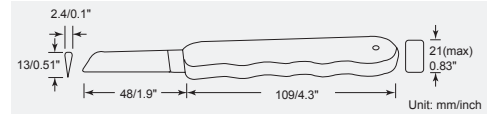

Handle	Blade	OAL.(mm/inch)	Individual packing
TPR	AISI 420	160/6.3	Blister card

## ▶ 900-257 Quick Point Snap-Blade Knife

- Includes 2 pcs blade inside
- Locking slide

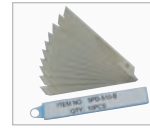

**900-257B**  
(10Pcs/Pack)

Economic Type

Handle	Blade	Replacement blade	OAL.(mm/inch)	Individual packing
ABS	SK-5	900-257B (10Pcs/Pack)	140/5.5	Blister card

## ▶ 900-169 Utility Knife



- All blades are made of high carbon tool steel SK-4
- Blade in thickness: 0.5mm
- includes 3 pcs blade inside

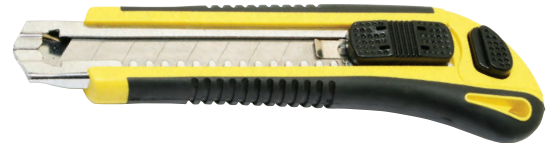

**900-169B**  
(6Pcs/Pack)



Handle	Blade	Replacement blade	OAL.(mm/inch)	Individual packing
ABS+TPR	SK-4	900-169B(6Pcs/Pack)	170/6.7	Blister card

## ▶ 900-229 Dualgrip Wallboard Saw



Material		Application	OAL. (mm/inch)	Individualpacking
Handle	Blade			
Plastic w/Rubber	-	Wallboard, plywood, plastic	318/12.7	Blister card

### ▶ 902-083/902-084 All Purpose Snip



Heavy-duty stainless steel blade

Safety latch for easy storage



902-083

Dual-color, Non-slip handle



902-084

- Cut cable, wire, cloth, carpet, leather, cardboard tin plate, branch, foam rubber and so on.
- Heavy-duty stainless steel blade.
- Dual-color, non-slip handle.



Leather



Aluminum sheet



Cable

Model No.	Material	Handle	Application	OAL. (mm/inch)	Individual packing
902-083	AISI 420	P.P+ T.P.R	Cardboard, PVC Leather, Rubber: thickness < 5mm. Aluminum sheet, Copper sheet: thickness <1mm Steel sheet: thickness < 0.5mm Cable, PVC water pipe, plastic tube up to Ø10mm	165/6.5	Blister card
902-084					

### ▶ 902-082 All Purpose Snip



- Ideal for cutting cable, leather, card-board, foam rubber and more.
- Non-slip handle, stainless steel blade and safety lock

Safety lock



Cable



Copper

Material	Handle	Application	OAL. (mm/inch)	Individual packing
AISI 410	P.P+ T.P.R	Cardboard, PVC Leather, Rubber: thickness < 3mm. Aluminum sheet, Copper sheet: thickness <1mm PVC, PET , plastic : thickness <0.2mm Fixable flat cable: thickness <0.3mm	165/6.5	Blister card

### ▶ 100-035 Fiber Optic Kevlar Cutter



For cutting Kevlar fiber optic cable



Micro serrated

Material	Handle	OAL. (mm/inch)	Individual packing
High carbon alloy steel	TPR	160/6.3	Blister card

### ▶ 100-049 Electrician's Scissor



for use in telephone and electrical service applications.



Scraper and file on side edge of blade.

Material	Handle	Application	OAL. (mm/inch)	Individual packing
AISI 420	Nylon+ Fiber	Stripping from AWG 18 and 22 wire Cutting up to AWG 16 solid wire and AWG 12 stranded wire	145/5.7	Blister card

### ▶ 902-230 7 in 1 Multi-Function Pocket Tool Key Chain



LED light



Be careful: a sharp blade can cut!



Material	HRC Body	Application	OAL. (mm/inch)	Individual packing
2Cr13	48°±3°	Serrated Saw, Opener & Slotted Screwdriver, Phillips Screwdriver, Fruit Knife, Mini LED Flashlight	67x32/2.6x1.3	Blister card

### ▶ SR-333 Micro Scissor



- Made of stainless steel to resist rust and corrosion.
- Dual color handle provides user comfort
- Return spring offers more smooth operation



Safety cap

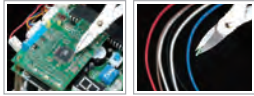

Material	Handle	Application	OAL. (mm/inch)	Individual packing
AISI 420	ABS+ TPE	Cooper, IC, component pin: thickness < 0.3mm. PVC, PET , plastic : thickness <0.2mm Fixable flat cable: thickness <0.3mm	120/4.7	Blister card



# CRIMPERS

CRIMPERS

















# Pro'sKit® Crimpers

All parts of **Pro'sKit** crimping tools are made of special steel, oil-hardened and tempered. They come with ergonomically designed handles and lever action features the optimum transmission of force for fatigue-reduced operation, and high crimping quality due to precision dies and integral ratcheting mechanism.

**Pro'sKit** crimping tools use interchangeable die sets to crimp a wide variety of different connectors for twisted pair & flat phone cable, fiber optic cable, coaxial cable, electrical and Industrial wire...etc.

## Symbols for Crimp die profiles

The **Pro'sKit** crimping dies are made from high precision lost-wax casting technology, providing the high accuracy and long service life!

-  4 pin(RJ22) telephone handset plugs
-  6 pin(RJ11/RJ12) telephone plugs
-  8 pin(RJ45) modular plugs
-  10 pin(RJ50) modular plugs
-  Telecom splice connectors
-  Pin terminal, insulated & non-insulated ferrules
-  Insulated & non-insulated wire ferrules
-  Non-insulated terminals & lugs
-  Open barrel, non-insulated terminals & lugs
-  D-Sub terminal & Non-Insulated Open Barrel Connectors
-  Insulated terminals, Insulated & Uninsulated Flag
-  Insulated terminals
-  RS-232 D-sub round barrel contact pins or sockets
-  Insulated & non-insulated wire ferrules
-  Hex type coaxial connectors & fiber optics connectors
-  Oval type coaxial connectors & fiber optics connectors
-  Square type coaxial connectors center contact pins

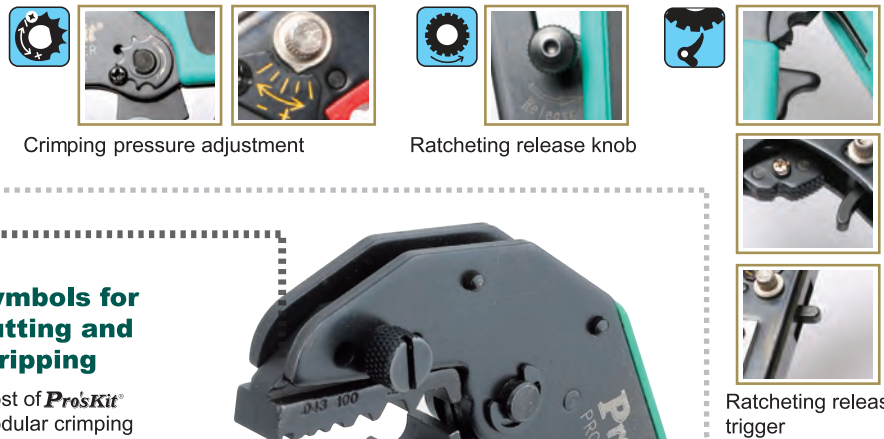

## Symbols for ratcheting mechanism

**Pro'sKit** ratcheting crimping tools usually combine crimping pressure adjustment and ratcheting release trigger. The different models have different ratcheting mechanism designs.



## Symbols for cutting and stripping

Most of **Pro'sKit** modular crimping tools usually feature cutting and stripping functions

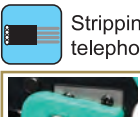
-  Cutting wires
-  Stripping flat telephone cables
-  Stripping twisted pair round cables



## Symbols for force-saving design

**Pro'sKit** new design of crimping tools designed with lever action, features optimum transmission of force for fatigue-reduced operation and comes with the ratcheting mechanism which helps to ensure the crimping quality. This design requires less force than general hand tools.

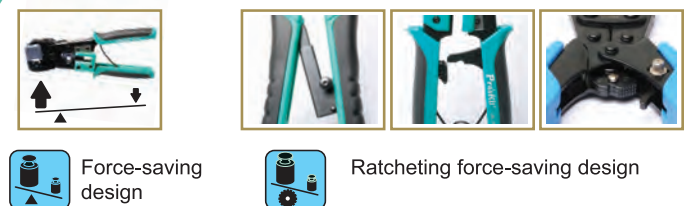

## CP-3005F Quick Interchange Ratcheting Crimper Frame



**Quick die change without tools**

Material: AISI 4140  
HRC43'±2'  
(Die not included)



Interchangeable die with quick release trigger

Material: S50C  
HRC: 45'±3'

Crimping pressure adjustment

Elastomeric resin, double TPR structure.

Ratcheting release trigger



Special quick release trigger design for easy die changes without extra tools

Material		HRC	OAL (mm/inch)	Individual packing
Body	Handle	Body		
S50C	TPR	45'±3'	226/9.3	Blister card

## 902-085 CrimPro Crimp Frame



**Crimping force saving up to 30%**

Change Dies with thumbscrews.

Elastomeric resin, double structure. non-slip.

Crimping pressure adjustment wheel

Ratcheting release trigger



Replacement Die Screw 300-056

- Right angled head design prevents awkward wrist bending during operation
- Interchangeable die with thumbscrew

Material		HRC	Replacement Die Screw	OAL (mm/inch)	Individual packing
Body	Handle	Body			
S45C	TPR	45'±3'	300-056	236/9.3	Blister card

We provide a variety of optional dies to meet the most applications, please contact our sales department to discuss custom needs. All dies on pages 55-57 fit these frame

TWEEZERS

PRECISION PLIERS & CUTTERS

ELECTRICAL PLIERS & CUTTERS

KNIVES, SCISSORS & SAWS

CRIMPERS

STRIPPERS

PUNCHDOWN TOOLS

SOLDERING / ASSEMBLY

SCREWDRIVERS/ BITS

HEX KEY/ WRENCHES

SOCKET WRENCHES

TWEEZERS

## ▶ 300-096 Ergo-Lunar Crimp Frame



**Crimping force saving up to 50%**



- 40%~50% lower crimping force
- Interchangeable die with thumbscrew

Material		HRC	Replacement Die Screw	OAL (mm/inch)	Individual packing
Body	Handle	Body			
S45C	PP	45° ±3°	300-056	260/10.2	Blister card

## ▶ 300-054 Lunar Crimp Frame



**Compact size for easy operation**



Material		HRC	Replacement Die Screw	OAL (mm/inch)	Individual packing
Body	Handle	Body			
S45C	PP+TPR	45° ±3°	300-056	220/8.6	Blister card

We provide a variety of optional dies to meet the most applications, please contact our sales department to discuss custom needs. All dies on pages 55-57 fit these frame





**300-096**  
Ergo-Lunar  
Crimp Frame



**300-054**  
Lunar  
Crimp Frame



**902-085**  
CrimPro Crimp  
Frame



**CP-3005F**  
Quick Interchange  
Ratcheting Crimper  
Frame

Note: CP-3005F sold as frame only, but all dies on this page fit it

DIE Set	Crimp die profile	Application	Crimp Size	Terminals	Description	Model No.
<b>Coaxial Connectors</b>						
		RG174, mini RG59 BNC/TNC connectors	HEX.068", .128", .178" HEX 1.73, 3.25, 4.52mm		Lunar frame w/die Ergo-Lunar frame w/die CrimPro frame w/die Die only	<b>300-190</b> <b>300-191</b> <b>300-192</b> <b>1PK-3003D7</b>
		Amphenol and General RG58, RG59, RG62, BNC/TNC, F-Type, LMR-240	SQ.052", HEX.068", .100", .213", .255" SQ1.32, HEX1.73, 2.54, 5.41, 6.48mm		Lunar frame w/die Ergo-Lunar frame w/die CrimPro frame w/die Die only	<b>902-277</b> <b>902-278</b> <b>902-279</b> <b>902-201</b>
		HDTV, SMA, True 75-ohm BNC/TNC & mini-UHF, RG174, RG59/62, mini-coaxial & Belden 1855A	SQ.042", HEX.068, .178", .197, .255" SQ 1.07mm, HEX1.73, 4.52, 5.00, 6.48mm		Lunar frame w/die Ergo-Lunar frame w/die CrimPro frame w/die Die only	<b>300-187</b> <b>300-188</b> <b>300-189</b> <b>1PK-3003D34</b>
		RG58, 59 and 62 AU, BNC and TNC 3-piece connectors	HEX.068", .213", .256" HEX1.73, 5.41, 6.5mm		Lunar frame w/die Ergo-Lunar frame w/die CrimPro frame w/die Die only	<b>300-019</b> <b>300-109</b> <b>902-143</b> <b>300-045</b>
		HDTV BNC/TNC 3-piece coaxial connectors	SQ .042", HEX.178", .275" SQ 1.07mm, HEX4.52, 6.99mm		Lunar frame w/die Ergo-Lunar frame w/die CrimPro frame w/die Die only	<b>300-184</b> <b>300-185</b> <b>300-186</b> <b>1PK-3003D33</b>
		HDTV true 75-ohm BNC/TNC coaxial connectors: Belden 1855A, 1865A, 1505A, 1505F, 1694A, 1694F	HEX .041", .068", .178", .255", .278" SQ1.04, HEX1.73, 4.52, 6.48, 7.06mm		Lunar frame w/die Ergo-Lunar frame w/die CrimPro frame w/die Die only	<b>300-158</b> <b>300-159</b> <b>902-171</b> <b>300-157</b>
		HDTV BNC/TNC 3-piece coaxial connectors	SQ.042", Hex. 197", .278" SQ1.07mm, HEX 5.00, 7.06mm		Lunar frame w/die Ergo-Lunar frame w/die CrimPro frame w/die Die only	<b>300-193</b> <b>300-194</b> <b>300-195</b> <b>1PK-3003D30</b>
		HDTV BNC/TNC true 75-ohm coaxial connectors, RG6, Belden 1694 & 1694A	SQ.042", HEX.068", .275", .278" SQ1.07mm, HEX1.73, 6.99, 7.06mm		Lunar frame w/die Ergo-Lunar frame w/die CrimPro frame w/die Die only	<b>300-178</b> <b>300-179</b> <b>300-180</b> <b>1PK-3003D31</b>
		BNC, TNC, Mini-UHF, RG58, 141, 142, 303, 400, 59, 62, 210 Belden 8279, 8281, 9231, 9141 RG-6, 212, 222, 304	HEX.068", .098", .213", .255", .321" HEX1.73, 2.49, 5.41, 6.48, 8.15mm		Lunar frame w/die Ergo-Lunar frame w/die CrimPro frame w/die Die only	<b>300-003</b> <b>300-119</b> <b>902-137</b> <b>300-038</b>
		RG59 and Belden 8281/1694A cable groups for both 50 & 75 ohm center pins	HEX.042", .068", .255", .324" HEX1.07, 1.73, 6.48, 8.23mm		Lunar frame w/die Ergo-Lunar frame w/die CrimPro frame w/die Die only	<b>300-022</b> <b>300-116</b> <b>902-146</b> <b>300-048</b>
		HDTV true 75 ohm BNC/TNC & CATV "F" coaxial connectors, RG59, RG6, Belden 8281, 1694A & 1505A	SQ .042", .052", HEX .068", .255", .324" SQ 1.07, 1.32mm, HEX1.73, 6.48, 8.23mm		Lunar frame w/die Ergo-Lunar frame w/die CrimPro frame w/die Die only	<b>300-181</b> <b>300-182</b> <b>300-183</b> <b>1PK-3003D32</b>
		CATV "F" connectors RG-59, RG-6 and RG-6 Quad	HEX.255", .320", .350" HEX6.48, 8.13, 8.89mm		Lunar frame w/die Ergo-Lunar frame w/die CrimPro frame w/die Die only	<b>300-007</b> <b>300-112</b> <b>902-139</b> <b>300-041</b>
		RG8, RG11, RG213, RG216 BNC, TNC and N Series Connectors LMR400	HEX.80", .100", .429" HEX2.03, 2.54, 10.90mm		Lunar frame w/die Ergo-Lunar frame w/die CrimPro frame w/die Die only	<b>300-023</b> <b>300-117</b> <b>902-147</b> <b>300-049</b>
		Crimps Amphenol connectors. Coaxial - Belden 7810A, 9913, 9914, LMR 400.	HEX .429", .118" HEX10.89, 3.00mm		Lunar frame w/die Ergo-Lunar frame w/die CrimPro frame w/die Die only	<b>300-163</b> <b>300-168</b> <b>300-173</b> <b>9PK-3003D29</b>
		Combi-Die for RJ45 WE/SS Modular plugs and RG6/6Q(CATV F-Type)	RJ45 plug HEX.324", .360" HEX 8.23, 9.14mm		Lunar frame w/die Ergo-Lunar frame w/die CrimPro frame w/die Die only	<b>300-161</b> <b>300-162</b> <b>902-172</b> <b>902-054</b>



**300-096**  
**Ergo-Lunar**  
**Crimp Frame**



**300-054**  
**Lunar**  
**Crimp Frame**





















**902-085**  
**CrimPro Crimp**  
**Frame**



**CP-3005F**  
**Quick Interchange**  
**Ratcheting Crimper**  
**Frame**

Note: CP-3005F sold as frame only, but all dies on this page fit it





DIE Set	Crimp die profile	Application	Crimp Size	Terminals	Description	Model No.
<b>Fiber Optic Connectors</b>						
		RG174,RG179 Belden 8218, fiber optics.	SQ.042", HEX.068", .078", .128", .151", .178" SQ1.07, HEX1.73, 1.98, 3.25, 3.84, 4.52mm		Lunar frame w/die	<b>300-024</b>
					Ergo-Lunar frame w/die	<b>300-118</b>
					CrimPro frame w/die	<b>902-148</b>
					Die only	<b>300-050</b>
		For FC,SC,ST,LC, SMA & MT-RJ fiber optics.	HEX .139", .151", .178", RD.134", .190" HEX3.53, 3.84, 4.52mm, RD3.40, 4.83mm		Lunar frame w/die	<b>300-167</b>
					Ergo-Lunar frame w/die	<b>300-172</b>
					CrimPro frame w/die	<b>300-177</b>
					Die only	<b>9CP-336DF4</b>
		SMA,SMB, FC Biconic and SC & ST fiber optic connectors, RG58, RG174, Belden8218	SQ.042", HEX.068", .151", .178", .213" SQ1.07, HEX1.73, 3.84, 4.52, 5.41mm		Lunar frame w/die	<b>300-021</b>
					Ergo-Lunar frame w/die	<b>300-115</b>
					CrimPro frame w/die	<b>902-145</b>
					Die only	<b>300-047</b>
		Fiber Optic and Coaxial SMA/SMB/ SFR Connectors SC/ST/FC	HEX.151", .178", .213" HEX3.84, 4.52, 5.41mm		Lunar frame w/die	<b>300-106</b>
					Ergo-Lunar frame w/die	<b>300-143</b>
					CrimPro frame w/die	<b>902-167</b>
					Die only	<b>300-102</b>
<b>Electrical and Industrial Terminals</b>						
		Miniature Insulated Terminals Nylon and Vinyl	AWG26-16 DIN 0.2-1.5mm <sup>2</sup>		Lunar frame w/die	<b>300-146</b>
					Ergo-Lunar frame w/die	<b>300-147</b>
					CrimPro frame w/die	<b>902-169</b>
					Die only	<b>300-104</b>
		Red, Yellow, Blue Insulated terminals AWG 10-12, 14-16, 18-22 Nylon and Vinyl	AWG22-18/16-14/12-10 DIN 0.5-1.0/1.5-2.5/4.0-6.0mm <sup>2</sup>		Lunar frame w/die	<b>300-002</b>
					Ergo-Lunar frame w/die	<b>300-108</b>
					CrimPro frame w/die	<b>902-152</b>
					Die only	<b>300-058</b>
		Thin Style Insulated Terminals (red/yellow/blue) Nylon and Vinyl	AWG22-18/16-14/12-10 DIN 0.5-1.0/1.5-2.5/4.0-6.0mm <sup>2</sup>		Lunar frame w/die	<b>300-141</b>
					Ergo-Lunar frame w/die	<b>300-142</b>
					CrimPro frame w/die	<b>902-166</b>
					Die only	<b>300-101</b>
		Insulated Terminals	AWG22-18/16-14/12-10/8 DIN 0.5-1.0/1.5-2.5/4.0-6.0/10.0mm <sup>2</sup>		Lunar frame w/die	<b>CP-336FD27</b>
					Ergo-Lunar frame w/die	<b>1PK-3003FD27</b>
					CrimPro frame w/die	<b>CP-372FD27</b>
					Die only	<b>9PK-3003D27</b>
		Uninsulated Terminals	AWG20-18/16-14/12-10/8 DIN 0.5-1.0/1.5-2.5/4.0-6.0/10.0mm <sup>2</sup>		Lunar frame w/die	<b>300-132</b>
					Ergo-Lunar frame w/die	<b>300-133</b>
					CrimPro frame w/die	<b>902-161</b>
					Die only	<b>300-095</b>
		Open Barrel Contacts Molex/Tyco D-Sub, Molex, AMP Style Pin	AWG30-24/22-18 DIN 0.05-0.25/0.5-1.0mm <sup>2</sup>		Lunar frame w/die	<b>300-164</b>
					Ergo-Lunar frame w/die	<b>300-169</b>
					CrimPro frame w/die	<b>300-174</b>
					Die only	<b>9PK-3003D36</b>
		Open barrel contacts D-sub, Molex, AMP style pin	AWG20-18/16-14/12-10 DIN 0.5-1.0/1.5-2.5/4.0-6.0mm <sup>2</sup>		Lunar frame w/die	<b>300-005</b>
					Ergo-Lunar frame w/die	<b>300-120</b>
					CrimPro frame w/die	<b>902-138</b>
					Die only	<b>300-039</b>
		For Red and Blue Insulated Flag Terminals AWG 22-18, 16-14	AWG22-18/16-14 DIN 0.5-1.0/1.5-2.5mm <sup>2</sup>		Lunar frame w/die	<b>300-072</b>
					Ergo-Lunar frame w/die	<b>300-130</b>
					CrimPro frame w/die	<b>902-158</b>
					Die only	<b>300-070</b>
		For Yellow and Blue insulated Flag Terminals	AWG16-14/12-10 DIN 1.5-2.5/4.0-6.0mm <sup>2</sup>		Lunar frame w/die	<b>902-332</b>
					Ergo-Lunar frame w/die	<b>902-331</b>
					CrimPro frame w/die	<b>902-330</b>
					Die only	<b>9PK-3003D42</b>
		Uninsulated Flag Terminals	AWG22-18/16-14 DIN 0.5-1.0/1.5-2.5mm <sup>2</sup>		Lunar frame w/die	<b>300-073</b>
					Ergo-Lunar frame w/die	<b>300-131</b>
					CrimPro frame w/die	<b>902-159</b>
					Die only	<b>300-071</b>

DIE Set	Crimp die profile	Application	Crimp Size	Terminals	Description	Model No.
<b>Electrical and Industrial Terminals</b>						
		Wire ferrules (Insulated and Non-Insulated)	AWG22/20/18/16/14/12 DIN 0.5/0.75/1.0/1.5/2.5/ 4.0mm <sup>2</sup>		Lunar frame w/die Ergo-Lunar frame w/die CrimPro frame w/die Die only	<b>300-001</b> <b>300-134</b> <b>902-162</b> <b>300-097</b>
		Wire Ferrules (Insulated and Non-Insulated)	AWG10/8/6 DIN 6/10/16mm <sup>2</sup>		Lunar frame w/die Ergo-Lunar frame w/die CrimPro frame w/die Die only	<b>300-144</b> <b>300-145</b> <b>902-168</b> <b>300-103</b>
		Wire Ferrules (Insulated and Non-Insulated)	AWG6/4/2 DIN 16/25/35mm <sup>2</sup>		Lunar frame w/die Ergo-Lunar frame w/die CrimPro frame w/die Die only	<b>300-077</b> <b>300-160</b> <b>902-160</b> <b>300-077D</b>
		Spark Plug Cable-Cut, Strip, Crimp	8-8.5mm Spark plug wires		Ergo-Lunar frame w/die CrimPro frame w/die Die only	<b>902-275</b> <b>902-276</b> <b>9PK-3003D26</b>
<b>Solar Terminals</b>						
		Multi-Contact (MC3)Ø3mm solar contacts	AWG14/12/10 DIN 2.5/4.0/6.0mm <sup>2</sup>		Lunar frame w/die Ergo-Lunar frame w/die CrimPro frame w/die Die only	<b>300-165</b> <b>300-170</b> <b>300-175</b> <b>CP-5S1D</b>
		Multi-Contact (MC4)Ø4mm solar contacts	AWG14/12/10 DIN 2.5/4.0/6.0mm <sup>2</sup>		Lunar frame w/die Ergo-Lunar frame w/die CrimPro frame w/die Die only	<b>300-166</b> <b>300-171</b> <b>300-176</b> <b>CP-5S2D</b>

## Solar Series Crimpers



Material	OAL (mm/inch)	Individual packing
S45C	203/8.12	Blister card

DIE Set	Crimp die profile	Application	Description	Model No.
		D-Subminiature contacts, RS232 pins & sockets AWG 30-18 Open Barrel contacts (Molex/AMP style)	Completed set with die Die only Frame only	<b>300-009</b> <b>300-086</b> <b>300-087</b>
		Wire Ferrules AWG 22-10	Completed set with die Die only Frame only	<b>300-010</b> <b>300-105</b> <b>300-087</b>

## 902-337 PowerPole® Crimper



Phillips long screw that holds the locator in place



PowerPole® is a registered trademark of Anderson Power products

Material	Application	OAL (mm/inch)	Individual packing
S45C	PowerPole® modular connector #15(20~16 AWG/0.5~1.0mm <sup>2</sup> ) #30(16~12 AWG/1.0~2.5mm <sup>2</sup> ) #45(14~10 AWG/1.5~4.0mm <sup>2</sup> )	260/10.2	Blister card

## CP-3006F Parallel Action Crimping Tool

- Features:**
- Reliable:** Parallel action crimping performance is consistent and accurate
  - Practical:** Safety crimp release helps eliminate rejected terminations due to incorrect positioning.
  - Comfortable:** Ergonomically shaped non-slip TPR handle for comfortable use in all conditions
  - Versatile:** Interchangeable die sets for wide range of applications.

Special design perfect fit for open barrel terminal and solar connectors

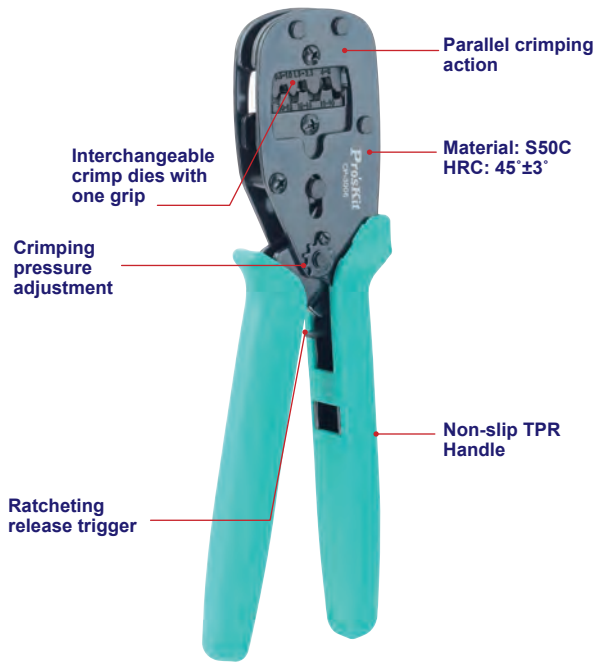

Material		HRC	OAL. (mm/inch)	Individual packing
Body	Handle			
S50C	TPR	45±3°	254/10	Blister card

Model No.	Replacement Die model no.	DIE Set	Crimp die profile	Application	Terminals
CP-3006F				Frame only	
CP-3006FD2	300-039			Non insulated open barrel connectors, commercial type AWG 22-18/16-14/12-10 DIN 0.5-1.0/1.5-2.5/4.0-6.0 mm <sup>2</sup> JIS 0.35-0.9/1.25-2.0/3.5-5.5 mm <sup>2</sup>	
CP-3006FD36	9PK-3003D36			Non-insulated open barrel connectors & D-SUB V.35 contact pins AWG 30-24/22-18 DIN 0.05-0.25/0.50-1.0 mm <sup>2</sup> JIS 0.05-0.25/0.35-0.9 mm <sup>2</sup>	
CP-3006FS1	CP-5S1D			For MC 3 solar connector (Multi-Contact) & 2.5/4.0/6.0 mm <sup>2</sup> (AWG 14/12/10) solar cable AWG 14/12/10 DIN 2.5/4.0/6.0 mm <sup>2</sup>	
CP-3006FS2	CP-5S2D			For MC 4 solar connector (Multi-Contact) & 2.5/4.0/6.0 mm <sup>2</sup> (AWG 14/12/10) solar cable AWG 14/12/10 DIN 2.5/4.0/6.0 mm <sup>2</sup>	

## PK-2061 Solar MC3 & MC4 Crimping Tool Kit

**This is a complete tool kit to install MC3 & MC4 solar connectors easily and accurately.**



- The Parallel action crimper features consistent and accurate performance
- Heavy duty Forged Cable Cutter with high leverage Jaw and shear blade for clean cut without damage.
- Prosoft screwdrivers for PV junction box installation

Includes 2 pcs MC4 and MC4 PLUS open-end spanner and unlocking tool help you opening the locking device, securing and tightening the cable gland.

Universal solar cable stripper comes with adjustable length stop for reliable stripping of the double layer insulated cables (2.5 - 6.0 mm<sup>2</sup>)



**Contents:**

Parallel Action Crimper frame
Die set for MC 3 solar connector (Multi-Contact) & 2.5/4/6mm <sup>2</sup> (AWG 14/12/10) solar cable.
Die set for MC 4 solar connector (Multi-Contact) & 2.5/4/6mm <sup>2</sup> (AWG 14/12/10) solar cable.
Universal solar cable stripper, for 2.5/4/6mm <sup>2</sup> (AWG 14/12/10) solar cable
Forging cable cutter (160mm), for copper cable: 25mm <sup>2</sup> flexible
2 Pcs Open-end spanner and unlocking tool (MC4 and MC4 PLUS)
Pro-soft screwdriver 5x75mm
Pro-soft screwdriver #2 x100mm
Zipper carrying bag-280x197x70(mm)/11"x7.8"x2.8"

## Professional Modular Crimps Strips & Cuts Tool

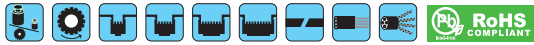

For AMP style connectors only

- For crimping modular plugs in parallel action.
- Cuts, strips, and crimps modular plugs without changing modular (DIE) set.

**300-064**



10P 10C, AMP  
8P8C/RJ-45 only



Stripping twisted  
pair round cable

**CP-376K**



## 300-004 4P/6P/8P Telecom Crimping Tool



4/6/8P Crimping



Strips twisted pair wire



Strips flat telephone wire



300-004B  
(6pcs/pack)

Model No.	Material	Handle	HRC	Application	Replacement blade	O.A.L (mm/inch)	Individual packing
300-064	S45C	Black:T.P.R Green:PP	45±3°	10P10C, AMP 8P8C/RJ45, 6P6C/RJ12, 6P4C/RJ11, 4P4C & 4P2C/RJ22 plugs, and DEC/Offset 6P6C plugs	-	205/8.1	Blister card
CP-376K				8P8C/RJ-45, 6P6C/RJ11, 4P4C & 4P2C/RJ22 plugs, and RJ11/6P6C DEC-Offset plugs	5PK-376K-BLADE(6pcs/pack)	205/8.1	
300-004				8P8C/RJ45, 6P2C/6P4C/6P6C RJ11 modular plugs, RJ-22 4P2C/4P4C handset modular plugs	300-004B (6Pcs/pack)	190/7.5	

## Modular Crimping Tool



**CP-376M**



Stripping



Cutting



Crimping



900-078  
(2pcs/pack)

**300-063**



## 902-086 Pro-Crimper Modular Tool



**Best Value**



300-004B  
(6pcs/pack)

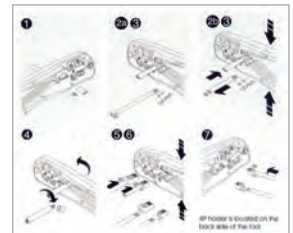

Model No.	Material	Handle	HRC	Application	Replacement blade	O.A.L (mm/inch)	Individual packing
CP-376M	S45C	Black:T.P.R Green:PP	HV 555~650°	8P8C/RJ45, 6P2C/6P4C/6P6C RJ11 modular plugs, RJ-22 4P2C/4P4C handset modular plugs	900-078 (2pcs/pack)	225/8.9	Blister card
300-063	S45C	Black:T.P.R Green:PP	HV 555~650°	8P8C/RJ45, 6P2C/6P4C/6P6C RJ11 modular plugs	900-078 (2pcs/pack)	216/8.5	Blister card
902-086	ABS + carbon steel	-	-	8P8C/RJ45, 6P2C/6P4C/6P6C RJ11 modular plugs, RJ-22 4P2C/4P4C handset modular plugs	300-004B (6Pcs/pack)	160/6.3	Blister card

TWEZERS  
PRECISION PLIERS & CUTTERS  
ELECTRICAL PLIERS & CUTTERS  
KNIVES, SCISSORS & SAWS  
CRIMPERS  
STRIPPERS  
PUNCHDOWN TOOLS  
SOLDERING / ASSEMBLY  
SCREWDRIVERS/ BITS  
HEX KEY/ WRENCHES  
SOCKET WRENCHES

### ▶ 300-018 Modular Crimping Tool



Lock for easy storage

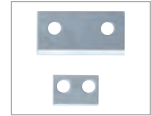

5CP-376E-B (2pcs/pack)



### ▶ 300-028/300-078 Economy All-In-One Modular Plug Crimper

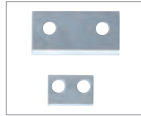

200-053 (2pcs/pack)

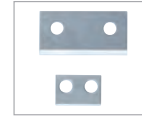

200-053 (2pcs/pack)

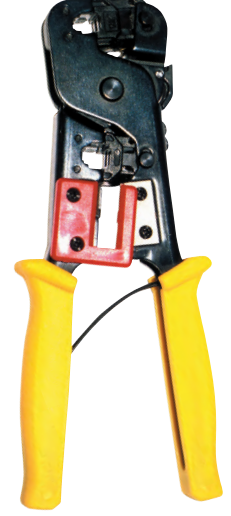

Model No.	Material	Handle	HRC	Application	Replacement blade	O.A.L.(mm/inch)	Individual packing
300-018	Low carbon steel	PP	45°±3°	8P8C/RJ45, 6P2C/6P4C/6P6C RJ11 modular plugs	5CP-376E-B (2pcs/pack)	200/7.9	Blister card
300-028	S45C	PP	45°±3°	8P8C/RJ45, 6P2C/6P4C/6P6C RJ11, DEC/MMJ modular plugs	200-053 (2pcs/pack)	200/7.9	Blister card
300-078	S45C	PP	45°±3°	6P2C/6P4C/6P6C RJ11 modular plugs, RJ-22 4P2C/4P4C handset modular plugs	200-053 (2pcs/pack)	200/7.9	Blister card

### ▶ 300-037 Pro-Crimper Modular Tool

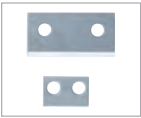
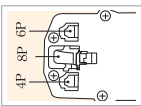

200-053 (2pcs/pack)



Crimping



Cutting



Wire Stripper

Wire Cutter

### ▶ 300-088/300-089/300-090 Modular Crimping Tool



300-004B (6pcs/pack)

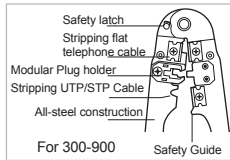

For 300-900 Safety Guide



### ▶ 100-008 Telecom Splice Crimp Tool



- Designed for UG, UR and UY connectors.
- A special stop behind cutout prevents connectors from damage.



### ▶ 900-055 Double End Socket Can Wrench



- Used to place fuses in cable terminals and connect wires to fuses and binding posts.
- 3/8" & 7/16" hex double end. Plastic handle.



Model No.	Material	Handle	HRC	Application	Replacement blade	O.A.L.(mm/inch)	Individual packing
300-037	Nylon+Fiber	-	-	8P8C/RJ45, 6P2C/6P4C/6P6C RJ11 modular plugs, RJ-22 4P2C/4P4C handset modular plugs	200-053 (2pcs/pack)	166/6.5	Blister card
300-088	Low carbon steel	PVC	HR30N 55-65	RJ-22 4P2C/4P4C handset modular plugs	900-117 (6pcs/pack)	190/7.5	Blister card
300-089	Low carbon steel	PVC	HR30N 55-65	6P2C/6P4C/6P6C RJ11 modular plugs	900-117 (6pcs/pack)	190/7.5	Blister card
300-090	Low carbon steel	PVC	HR30N 55-65	8P8C/RJ45 modular plugs	300-004B (6Pcs/pack)	200/8	Blister card
100-008	-	-	-	UR,UY,UG connectors Solid copper wire UR 19 to 26AWG UY 22 to 26 AWG UG 19 to 26 AWG	-	150/5.9	Blister card
900-055	S45C	Plastic	45°±3°	-	-	180/7.1	Blister card

### ▶ 902-087 Fiber Optic Crimping Tool



This is a rugged, easy to use, well made Crimp Tool, crimps broad range of fiber optic connectors or coaxial cable applications.

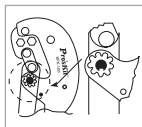

Adjustable Disc



### ▶ 902-270 Heavy Duty Coaxial Crimping Tool

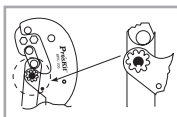

Adjustable Disc



### ▶ 300-074 "F" Type Crimper



Model No.	Material	Handle	HRC	Application	O.A.L.(mm/inch)	Individual packing
902-087	S45C DIE: AISI 4140	PP	45±3°	SC & ST fiber optic connectors HEX .122", .133", .151", .188" HEX 3.10, 3.38, 3.84, 4.78mm	240/9.4	Blister card
902-270	S45C DIE: AISI 4140	PP	45±3°	RG58, RG59, 6, 11 & UHF-58, 8 Cables and BNC, TNC Connectors HEX:.100", .359", .406	225/9	Blister card
300-074	S45C DIE: AISI 4140	PP	46±3°	RG59, 6, 62 Cables and CATV Connectors HEX:.322", .255"	225/9	Blister card

### ▶ 300-092 Plier Style Economy Crimper



• For RG59/62/6 and F-connectors



### ▶ 300-091/CP-808 Compression Connector Crimping Tool



• For RG-58, RG-59, RG-6 and F connectors.



• For RG-58, RG-59 and RG-6 (F,BNC,RCA) connectors.  
• Advanced ratchet mechanism.  
• Anti-slip handle for easy operation.

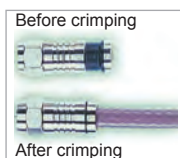

300-091



RCA waterproof connectors



BNC waterproof connectors



F waterproof connectors



CP-808

Model No.	Material	Handle	HRC	Application	O.A.L.(mm/inch)	Individual packing
300-092	Carbon steel	PVC	45±3°	RG59/62, 6 hex type, F connector	200/8	Blister card
CP-808	Middle carbon steel	TPR+PP	45±3°	RG-58, 59, 6 (3C, 4C, 5C), F / BNC / RCA Connectors	195/7.7	Blister card
300-091	S45C	PVC	45±3°	RG-58, 59, 6 (3C, 4C, 5C), F Connectors	215/8.5	Blister card

TWEEZERS  
PRECISION PLIERS & CUTTERS  
ELECTRICAL PLIERS & CUTTERS  
KNIVES, SCISSORS & SAWS  
CRIMPERS  
STRIPPERS  
PUNCHDOWN TOOLS  
SOLDERING / ASSEMBLY  
SCREWDRIVERS/ BITS  
HEX KEY/ WRENCHES  
SOCKET WRENCHES  
TWEEZERS

### ▶ 902-265 Compression Connector Crimping Tool

- Crimps RG58/59/6/6 Quad F-Compression Connectors.
- Crimps RG7/8/11 Riser F-Compression Connectors.
- Fully adjustable to fit common connector sizes.



### ▶ 300-156 Compression Connector Crimping Tool

- Universal tool for all F, BNC, and RCA connectors.
- Works on RG58/59/6/6Q and large RG7/11 Riser Cable Connectors.



Model No.	Material	Handle	HRC	Application	O.A.L (mm/inch)	Individual packing
902-265	Carbon steel + ABS	PP	40±5°	RG-58, 59, 6, 8, 11 / F Connector	174/6.8	Blister card
300-156	Aluminum	PVC	45±3°	RG-58, 59, 6, 8, 11 / F, BNC, RCA Connectors	170/6.7	Blister card

### ▶ CP-315 Adjustable Compression Tool



### ▶ CP-313 Adjustable Compression Crimping Tool



### ▶ 902-245 Compression Connector Crimping Tool



Model No.	Material	Handle	HRC	Application	O.A.L (mm/inch)	Individual packing
CP-315	Carbon steel	Nylon	40±5°	Connecting waterproof connectors F, BNC, RCA on RG-58, RG-59 and RG-6 coaxial cables	120/4.7	Blister card
902-245	Carbon Steel + ABS	PVC	40±5°	RG-58, 59, 6 / F Connector	143/5.6	Blister card
CP-313	Carbon steel	PVC	40±5°	RG-58, 59, 6 (3C, 4C, 5C), F / BNC / RCA Connectors	152/6.0	Blister card

### ▶ MS-3207 Advanced 3 in 1 Connector Tool



- Comes with 3 different positions: RG-59, RG-6 and F connectors.
- Users can use one end to enlarge space between shield and insulation for RG59, another end for RG6, the other end locks F connector into tool socket and twist it onto a stripped cable end.



### ▶ 800-072/800-079 CATV Install/Extract Tool

- Installs and removes F-Type connectors in hard to reach places
- Handle contains male F-Type holder

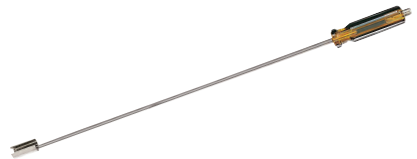

### ▶ 800-049/800-050 BNC Connector Insertion/Removal Tool

- Provides easy access to difficult to reach, high density connectors

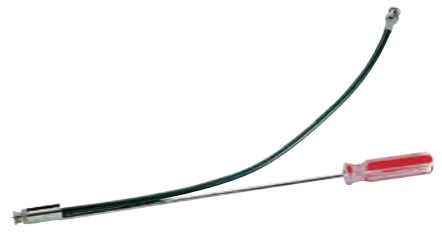

Model No.	Material	Handle	HRC	Application	O.A.L (mm/inch)	Individual packing
MS-3207	PP	-	-	RG59, RG6, F connectors	100/3.9	Blister card
800-072	Cr-V	PVC	45°±3°	-	300/12	Polybag+header card
800-079	Cr-V	PVC	45°±3°	-	150/6	Polybag+header card
800-049	Cr-V	PVC	45°±3°	-	200/8	Polybag+header card
800-050	Cr-V	PVC	45°±3°	-	300/12	Polybag+header card



### ▶ Crimper Insulated and Non-Insulated Wire Ferrules



300-149

**Self-Adjusting**



### ▶ 300-075 D-Sub, 2-Stage, Open Barrel Crimper



### ▶ 300-035 Multi-Purpose Crimper



Model No.	Material	Handle	HRC	Application	O.A.L (mm/inch)	Individual packing
300-149	S45C	PP	45°±3°	For Insulated and Non-Insulated Wire Ferrules and AWG20-12 wire	205/8.1	Blister card
300-075	Carbon steel	Cushion	45°±3°	For crimping D-Sub AWG.20/24/28	175/6.9	Blister card
300-035	Carbon steel	Cushion	45°±3°	For computer pins & sockets, D-Sub 26-28 AWG wire, For butt-Insulated connectors, 22-26 AWG wire, For telephone piercing spade lugs, 22-26 AWG wire, For open barrel connectors, 20-22 AWG wire, For open barrel connectors, 14-18 AWG wire, For non-insulated terminals, 10-14,16-18 and 20-22 AWG wire	185/7.3	Blister card

### ▶ 500-037 Insulated Terminal Crimp Kit



- Ratcheted Crimper
- Ring insulated Terminal (22-16 AWG & Stud size : #6 ) X 50 pcs
- Ring insulated Terminal (16-14 AWG & Stud size : #8) X 40 pcs
- Ring insulated Terminal (12-10 AWG & Stud size : #10) X 20 pcs
- Butt Splice insulated (22-16 AWG) x 30 pcs
- Butt Splice insulated (16-14 AWG) x 20 pcs
- Butt Splice insulated (12-10 AWG) x 15 pcs

### ▶ 300-011 IDC Crimp Tool



- For crimping IDC-type of connectors onto flat cables

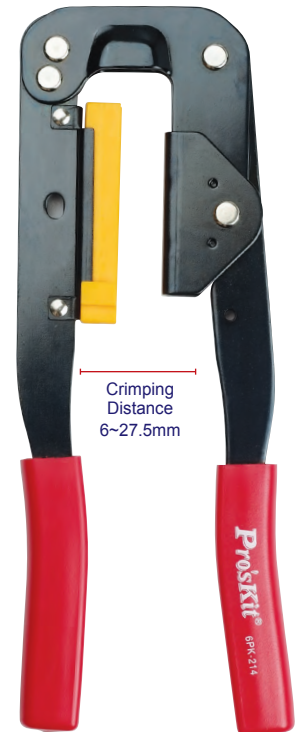
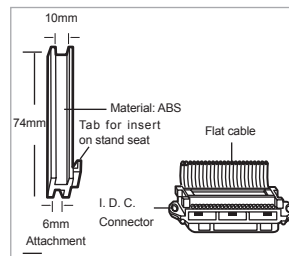

Material	Handle	HRC	Application	O.A.L (mm/inch)	Individual packing
Low carbon DIE:ABS Handle:PP	PVC	45°±3°	IDC-type connectors Height: 6mm~27.5mm Width(Max): 55mm	240/9.4	Blister card

TWEEZERS  
PRECISION PLIERS  
ELECTRICAL PLIERS & CUTTERS  
KNIVES, SCISSORS & SAWS  
CRIMPERS  
STRIPPERS  
PUNCHDOWN TOOLS  
SOLDERING / ASSEMBLY  
SCREWDRIVERS/ BITS  
HEX KEY/ WRENCHES  
SOCKET WRENCHES  
TWEEZERS

### CP-463 D-Sub Contact Crimping Tool



- Features**
- Ergonomic handle design provides low-effort operation
  - Superior pull strength results
  - High quality crimping standard ensures repetitive, reliable crimping action
  - Adjustable pin height locator

**For Larger Wire Size**



4 Way to Crimping

Material	HRC	Handle	Application	O.A.L (mm/inch)	Individual packing
SPPC + carbon steel	45°±3°	PVC	Crimping of closed-barrel RS-232 D-sub contacts. AWG 20-12 / DIN 0.5-4.0 mm <sup>2</sup> JIS 0.5-3.5 mm <sup>2</sup>	165/6.5	Blister card

### 300-015 4 Way Indent Crimping Tool



- Features**
- Used to crimp closed barrel, screw machine pin and socket style contacts.
  - Performs a simultaneous 4 indent crimp for superior contact retention.

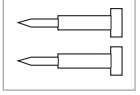

4 Way to Crimping

Material	HRC	Handle	Application	O.A.L (mm/inch)	Individual packing
S50C	45°±3°	PVC	Crimping of closed-barrel RS-232 D-sub contacts. AWG 26-20, DIN 0.2-0.5 mm <sup>2</sup> , JIS 0.2-0.5 mm <sup>2</sup>	162 /6.4	Blister card

### CP-416 Cutter/Stripper & Crimper Insulated and Non-Insulated Wire Ferrules



**3 in 1**

- Features:**
- All in one combination for crimping, stripping and cutting.
  - Made of high quality carbon steel with black oxide finished for anti-rust.
  - PVC cushion grip handle provides user comfort.
  - The stripper is processed by CNC lathe to ensure the accuracy.



wire ferrules crimping Wire cutter Wire stripper

Material	Handle	HRC	Application	O.A.L (mm/inch)	Individual packing
DIE: 4140 Frame: S45C	PVC	DIE: 42°±2° Frame: 44°±2°	Crimping, Wire Ferrules 0.25~2.5 mm <sup>2</sup> , Stripping wire AWG 26~14	200/8	Blister card

### CP-462G Wire Ferrule Crimp Tool-Square Crimp



**NEW**

- Features:**
- Adjustable ratchet and lever action construction reduces fatigue degree
  - Special four-mandrel crimping style for square crimp.
  - High quality crimping standard ensures repeatable crimping action.

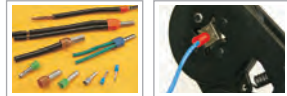

Four-mandrel for square crimp

Material	HRC	Handle	Application	O.A.L (mm/inch)	Individual packing
S44C	40°±2°	Nylon	Usable for cord end terminals AWG 26 ~ 10 DIN 0.25 ~ 6.0 mm <sup>2</sup> JIS 0.20 ~ 5.5 mm <sup>2</sup>	175/6.9	Blister card

### 300-016 Precision Crimping Tool With Wire Ferrules



- Including wire ferrules
- 0.5 x 6mm: 40pcs
  - 0.75 x 6mm: 40pcs
  - 1.0 x 6mm: 30pcs
  - 1.5 x 7mm: 20pcs
  - 2.5 x 7mm: 20pcs



Terminal crimper



Material	Handle	HRC
S45C	PVC	45°±3°

Application	O.A.L (mm/inch)	Individual packing
Non-insulated wire ferrules AWG 23/22/20/18/17/15/13, 0.25/ 0.34/0.5/ 0.75/1.0/1.5/2.5mm <sup>2</sup>	160/6.3	Blister card

### 900-065 Insertion/Extraction Tool





- Features**
- RS232 insertion & extraction use
  - Red: insertion PIN
  - White: extraction PIN



Model No.	Body	Handle	O.A.L (mm/inch)	Individual packing
900-065	Metal	PP	102/4	Pouch

## ▶ CP-251B/CP-351B Modular Ratchet Crimping Tool

-    • New generation of energy saving crimper designed for Non-Insulated Spade/Ring Terminals.
- Equipped with outstanding ratcheting cycle and quick safety release.
- Anti-rust, blackened surface finish.
- All stressed parts are made of high quality steel, oil-hardened and tempered.
- High leverage handles, compound action mechanism provide superior mechanical advantage.

### CP-251B



(For Non-Insulated Terminal)





Energy saving ratcheting design

### CP-351B



Model No.	Material	HRC	Handle	Application	OAL (mm/inch)	Individual packing
CP-251B	Frame:S50C Die: AISI 4140	45 ±3'	TPR	Non-insulated spade/ring terminals, AWG 22-16/16-14/12-10/8/6, DIN 1.5/2.5/6.0/10/16 mm <sup>2</sup> JIS 1.25/2.0/5.5/8.0/14 mm <sup>2</sup>	245/9.6	Blister card
CP-351B	Frame:S50C Die: 4340	45 ±3'	TPR	For crimping AWG 8, 6, 4, 2, JIS 8, 14, 22, 38 mm <sup>2</sup> , DIN 10, 16, 25, 35mm <sup>2</sup>	350/13.8	Inner box + color label

## ▶ 300-055 Non-Insulated Terminal Crimper

-    • Energy saving ratcheting crimper designed for non-insulated spade/ring terminals
- High leverage handles, compound action mechanism provide superior mechanical advantage.

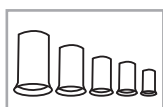
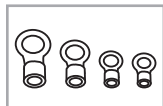
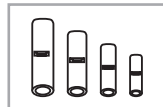

(For Non-Insulated Terminal)



Material	HRC	Application	O.A.L (mm/inch)	Individual packing
Frame:S45C Die:SK-5	39 ±2'	For Solderless, Non-Insulated terminals and AWG.22-16/16-14/12-10/8/6	185/7.3	Blister card

## ▶ 300-107 Heavy Duty Crimping Tool



- The best crimping solution for heavy duty tinned terminals
- Adjustable crimp nests with clearly marked gauges
- Lightweight and easy for operation
- Rugged cast steel construction for durability
- For terminating insulated and non-insulated cable lugs from AWG 8 to 250MCM copper and AWG 8 to 4/0 Aluminum



Material	HRC	Application	O.A.L (mm/inch)	Individual packing
Body: FCD45 Die: SK5	40 ±2'	AWG 8, 6, 4, 2, 1/0, 2/0, 3/0, 4/0, DIN 10, 16, 25, 35, 50, 70, 95, 120mm <sup>2</sup> , JIS 8, 14, 22, 38, 60, 70, 80, 100 mm <sup>2</sup>	570/22.4	Inner box+ color label

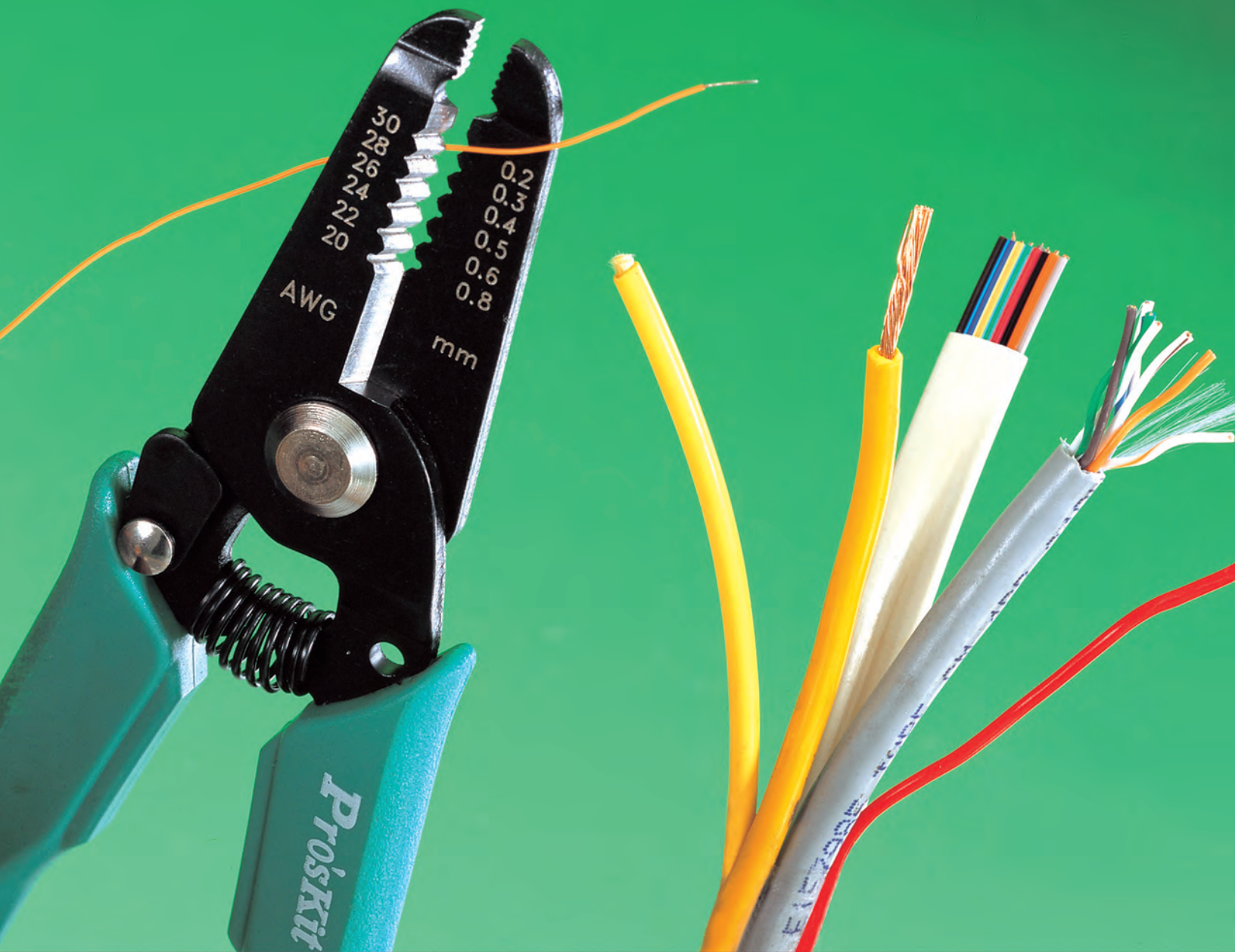

# STRIPPERS

# Pro'sKit® Strippers

All Pro'sKit® precision strippers pass strict quality control using precision instruments and ensuring accurate stripping with much less effort against injury and long service life. Pro'sKit® offers a complete range of strippers, including precision wire strippers, automatic wire strippers, coaxial cable strippers, round cable slitting & ringing tools, for most applications, such as electrical wire, hook-up wire, multi-conductor cable, flat telephone cable, twisted pair round cables, coaxial cables, fiber optics cables...etc.



## Gripping

Mainly used in holding, pulling and bending wires.

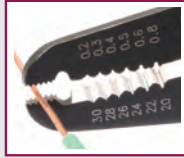

## Cutting wires



With cutting edge for soft wires from Ø0.25 to Ø1.2mm(AWG 30 to 16), not for hard or thick objects.

## Wire spring



The spring design is very important! It allows handles to self-open to make work faster with much less effort.

## Stripping wires

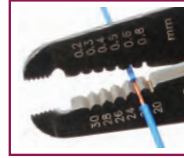

Pro'sKit® precision strippers are processed by CNC machine to guarantee the accurate size of notches for accurate stripping without damage.



Pro'sKit® end-action wire stripper comes with V type design and screw adjustment to preset wire size up to 3.9mm/0.15".



Pro'sKit® automatic wire stripper requires much less effort to strip wires quickly. The notch size could be custom made upon special request.



## 2 blade stripping coaxial cables

2 blade coaxial cable stripper usually used in stripping braided shields coaxial cables

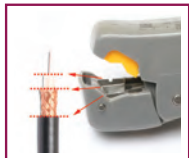

## 3 blade stripping coaxial cables

3 blade coaxial cable stripper usually used for stripping foil/braided shields coaxial cables

Pro'sKit® coaxial cable strippers and twisted pair round cable strippers are designed with lever action that requires much less force for operating as effectively as possible. Blades made from special grade steel provide sharp and durable edges. Some of Pro'sKit strippers come with adjustable wire size function to preset wire size to meet applications requirement.

## Cutting wires

Coaxial & twisted pair round cable strippers With cutting edge for cutting soft wires from Ø0.25 to Ø1.0mm(AWG 30 to 18), not for hard or thick objects.

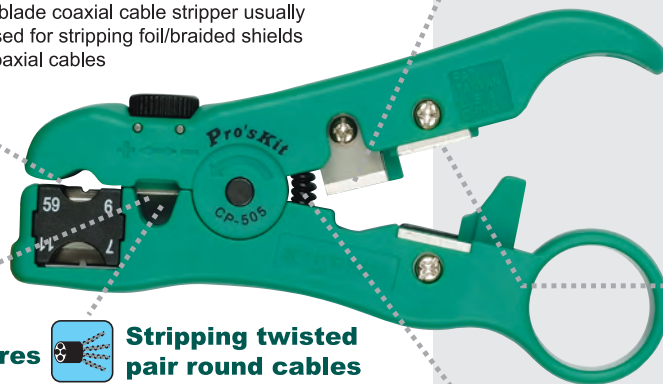

## Stripping wires

For stripping electrical wires

## Stripping twisted pair round cables

For stripping twisted pair round cables.



## Wire spring

## Stripping flat telephone cables

For stripping flat telephone cables



### Safety Caution



- Blades are very sharp, please use carefully and keep them out of reach of children.
- Blades are consumables, please replace when worn or damaged.

## ▶ SR-363A/SR-363B 2 in 1 Round Cable Cutter & Stripper



SR-363A

SR-363B



• The stripper is processed by CNC machining process to ensure its accuracy.



Cutting round cable



Stripping

Model No.	Material		HRC	Application	O.A.L (mm/inch)	Individual packing
	Body	Handle				
SR-363A	SK5	TPR	54±3°	Stripping AWG 14/12/10/8 Cutting round cable up to 10.7mm	168/6.6	Blister card
SR-363B				Stripping AWG 20/18/16/14/12/10 Cutting round cable up to 10.7mm		

## ▶ CP-301G Precision Wire Stripper

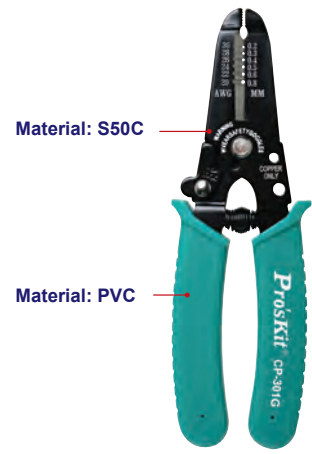

Material: S50C

Material: PVC



Heat-treated sharp angle w/fine laser marking



Safety lock design

Material	Hardness	Handle	Application	O.A.L (mm/inch)	Individual packing
S50C	45±3°	PVC	30,28,26,24,22,20 AWG / 0.2,0.3,0.4,0.5,0.6,0.8 mm	165/6.5	Blister card

## ▶ CP-302G Precision Wire Stripper

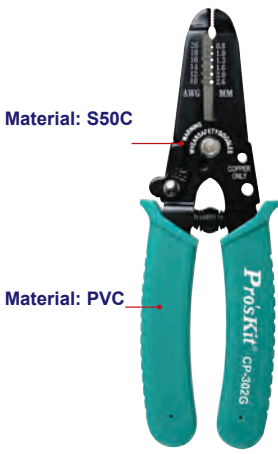

Material: S50C

Material: PVC



Heat-treated sharp angle w/fine laser marking



Safety lock design

Material	Hardness	Handle	Application	O.A.L (mm/inch)	Individual packing
S50C	45±3°	PVC	20,18,16,14,12,10 AWG / 0.8,1.0,1.3,1.6,2.0,2.6 mm	165/6.5	Blister card

## ▶ 902-090 Precision Wire Stripper



- Plier nose
- Cutter jaws
- Soft handles
- Spring return



Material	Hardness	Handle	Application	O.A.L (mm/inch)	Individual packing
SK7	50±3°	PVC	For cutting and stripping AWG 16, 14, 12, 10, 8	156/6.1	Blister card

## ▶ 200-047 Fiber Optic Stripper



• Strips 125 micron glass fiber with 250 micron buffer coating without scratching or nicking glass fiber.



Material	Application	O.A.L (mm/inch)	Individual packing
Blade:S50C	Strips 125 micron glass fiber with 250 micron buffer coating without scratching or nicking glass fiber.	148/5.8	Blister card

## ▶ CP-412G/CP-413G Heavy Duty Wire Strippers/Crimpers

### CP-412G

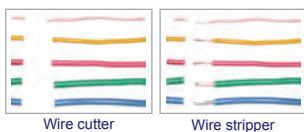
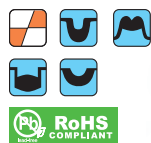

Bolt cutter



Crimp insulated and non-insulated Terminals

### CP-413G

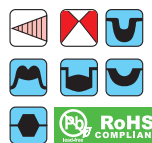

Model No.	Material	Handle	HRC	Application			OAL (mm/inch)	Individual packing
				Wire strip	Bolt cutter	Crimp		
CP-412G	S50C	PVC	45±3°	Stranded wire: 12-24AWG Solid wire: 10-24AWG	4-40, 8-32, 6-32, 10-32, 10-24	10-22 AWG (Barrel-type insulated and Non-Insulated terminal)	206/8.1	Blister card
CP-413G	S50C	PVC	45±3°	Stranded Wire: 26-24, 22-20, 18, 16, 14, 12, 10 AWG Solid Wire: 22-20, 18, 16, 14, 12, 10, 8 AWG	4-40, 10-32, 10-24, 8-32, 6-32	26-14, 12-10 AWG (Insulated Terminal) 22-10 AWG (Non-Insulated Terminal)	215/8.5	Blister card

## ▶ 100-002 Crimping Tool

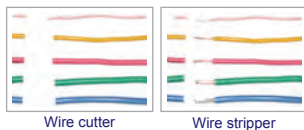

Wire cutter

Wire stripper



Bolt cutter



Crimp insulated and non-insulated Terminals

Material	Handle	HRC	Application			OAL (mm/inch)	Individual packing
			Wire strip	Bolt cutter	Crimp		
SAE1008	PVC	HV 450-800	AWG: 10, 12, 14, 16, 18, 20-22	4-40, 6-32, 10-24, 10-32, 8-32	Insulation: 16-14, 12-10, 22-18 Non-insulation: 22-18, 16-14, 12-10 AWG	235/9.3	Blister card

## ▶ 902-088 Multi-Purpose Crimping Tool



Material	Hardness	Handle	Application			O.A.L (mm/inch)	Individual packing
			Strip	Cutter	Crimp		
S45C	HRC: 45±3°	PVC	10, 12, 14, 16, 18, 20, 22, AWG	Bolt cutter: 4-40, 5-40, 6-32, 8-32, 10-32, 10-24	Insulation & Non-insulation: 10-16, 18-22AWG	210/8.3	Blister card

## ▶ 902-247 Adjustable Stripper



- For removing insulation from electrical wire.
- Rotating dial allows effortless changes between wire sizes.
- Hardened steel cutting jaws for clean wire cuts.
- Spring-opening jaws for repetitive stripping and cutting.
- Jaw lock protects cutting edges when tool is not in use.
- Vinyl cushion handles.



Material	Hardness	Handle	Application	O.A.L (mm/inch)	Individual packing
S45C	45±3°	PVC	For stripping AWG 26-12	140/5.5	Blister card

## ▶ CP-415 Cutter Stripper and Crimper



Stripper



Cutter

O.A.L (mm/inch)	Individual packing
175/6.9	Blister card

Material	Hardness	Handle	Application		
			Strip	Cutter	Crimp
SK7	HRC: 53±3°	TPR	10-30 AWG (5.5-0.05mm <sup>2</sup> )	Cutter: 12-30 AWG (2.0-0.25 mm) Cutter: 10-30 AWG (5.5-0.05 mm <sup>2</sup> )	AWG: 12-10/16-14/22-18 JIS: 5.5-3.5/2.0/1.25mm <sup>2</sup> DIN: 6-4/2.5/0.9 mm <sup>2</sup>

TWEZERS  
PRECISION PLIERS & CUTTERS  
ELECTRICAL PLIERS & CUTTERS  
KNIVES, SCISSORS & SAWS  
CRIMPERS  
STRIPPERS  
PUNCHDOWN TOOLS  
SOLDERING / ASSEMBLY  
SCREWDRIVERS/ BITS  
HEX KEY/ WRENCHES  
SOCKET WRENCHES  
TWEZERS

### ▶ 200-007 Adjustable Stripper with spring 200-007W Stripper without spring

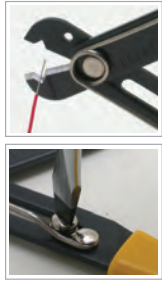

Model No.	Material	Hardness	Handle	Application	O.A.L. (mm/inch)	Individual packing
200-007	S45C	45±2°	PVC	Stripping wire From10~30 AWG/4~0.5mm (with spring)	127/5.0	Blister card
200-007W	S45C	45±2°	PVC	Stripping wire From10~30 AWG/4~0.5mm (without spring)	127/5.0	Blister card

### ▶ 200-085 Wire Stripper-Cutter W/Spring



Material	Hardness	Handle	Application	O.A.L. (mm/inch)	Individual packing
S45C	45±3°	PVC	For cutting and stripping AWG 24-10	132/5.2	Blister card

### ▶ CP-511A Universal Stripping Tool



Stripping low volt cable Ø8~13mm



Stripping regular cable, AWG 20~10(0.5~6mm<sup>2</sup>) and RG59, RG6 Coaxial Cable



Material		Application	O.A.L. (mm/inch)	Individual packing
Blade	Body			
SK5	ABS+TPR	Regular cable AWG 20/18/16/14/12/10(0.5/1.0/2.5/4.0/6.0 mm <sup>2</sup> ), RG59/RG6 coaxial cable, Ø8~13mm low-volt cable	125/4.9	Blister card

### ▶ 200-009/200-048 Rotary Cable Slitter



Cable slitting and stripping



Replacement blade: 200-036

O.A.L. (mm/inch)	Individual packing
140/5.5	Blister card

Model No.	Material		Application	Replacement blade
	Blade	Body		
200-009	Blade: SWP spring steel Blade holder: Metal	Nylon+Fiber	Range 0.18"~1.0" diameter	200-036
200-048	Blade: SWP spring steel Blade holder: Metal	Nylon+Fiber	Range 1.0"~1.4" diameter	200-036

### ▶ 200-042 Economy UTP Stripper



- A simple tool for UTP/STP cable.
- Rotate stripper just three times to extract the jacket of cable.
- Also a function for 110 punch down tool.

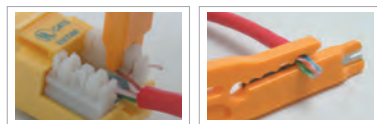

Material	Application	O.A.L. (mm/inch)	Individual packing
Poly-Resin	Stripping UTP/STP cable & 110 punch down	94/3.7	Blister card

### ▶ 200-042-100 Economy UTP Stripper (100pcs/jug)

- A simple tool for UTP/STP cable.
- Rotate stripper just three times to extract the jacket of cable.
- Also a function for 110 punch down tool.



Material	Application	O.A.L. (mm/inch)	Individual packing
Poly-Resin	Stripping UTP/STP cable & 110 punch down	94/3.7	Color Label



### ▶ CP-246 Solar Cable Stripper

- With adjustable length stop for accurate stripping length setting



Material		HRC	Application	O.A.L. (mm)	Individual packing
Body	Blade Handle				
Zinc alloy	SK5 TPR	56±2°	For 2.5/4/6mm <sup>2</sup> (AWG 14/12/10) solar cable	177/7	Blister card

### ▶ CP-367A Self-Adjusting Insulation Stripper

- RoHS COMPLIANT**
- To adjust length stop of 5-12mm
- Fully insulated for user comfort!



Material		HRC	Application	O.A.L. (mm/inch)	Individual packing
Body	Blade				
Nylon	SK5	55±3°	Stripping: AWG24~10/0.2~6.0mm <sup>2</sup> Cutter: under Ø 2.0mm	115/4.5	Blister card

### ▶ 200-072 Automatic Wire Stripper & Crimper

- The EASY STRIPPER cutters are made by precision machines for a long-life use.
- 15N 88~90 (HRC55°~60°) blade cuts wire fast and smoothly.
- Plastic insulated handles keep your work safe.

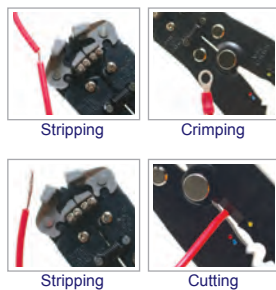

Model No.	Material			Blade HRC	Application	O.A.L. (mm/inch)	Individual packing
	Body	Blade	Handle				
200-072	SS 41	Powder metallurgy	PVC	52°~57°	Stripper range: AWG 24-10 (0.2~6.0mm <sup>2</sup> ) For insulated terminals AWG 22-10 (0.5-6.0mm <sup>2</sup> ) For non-insulated terminals AWG 22-10 (0.5-6.0mm <sup>2</sup> ) For auto ignition terminals 7-8mm	210/8.3	Blister card
200-070	SS 41	Powder metallurgy	ABS+TPR	52°~57°	Stripper range: AWG 24-10 (0.2~6.0mm <sup>2</sup> ) For insulated terminals AWG 22-10 (0.5-6.0mm <sup>2</sup> ) For non-insulated terminals AWG 22-10 (0.5-6.0mm <sup>2</sup> ) For auto ignition terminals 7-8mm	210/8.3	Blister card

### ▶ 200-003 Wire Stripping Tool

- 



Material			Blade HRC	Application	O.A.L. (mm/inch)	Individual packing
Body	Blade	Handle				
Zinc alloy	S45C	PVC	45°~55°	Stranded/Solid wire: AWG 22, 18-20, 14-16, 12, 10, 8	170/6.7	Blister card

### ▶ 200-091 Wire Stripping Tool

- 



Cutting

Material		HRC Blade	Application	O.A.L. (mm/inch)	Individual packing
Body	Blade				
ABS & low carbon steel	65Mn	45°~55°	Stripping flexible cable from 0.2~4mm <sup>2</sup> (AWG 24-12)	172/6.8	Blister card

### ▶ 200-070 Automatic Wire Stripper & Crimper

- Micro adjusting the swivel knob to strip electrical wire gauge smaller than AWG24 (0.2mm<sup>2</sup>).
- Adjustable stopper is swiveled if user does not use this function.

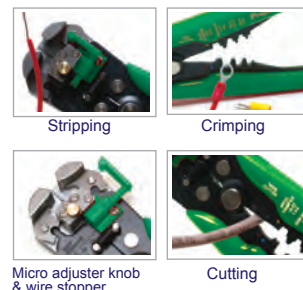

Micro adjuster knob & wire stopper

## ▶ CP-522 Rotary Coaxial Cable Stripper



2 Blade Model  
 6 mm/0.24"



Replacement blade cassette:  
 902-268  
 (1pcs/pack)



Material		Application	O.A.L. (mm/inch)	Individual packing
Body	Blade			
ABS	SK5	coaxial cable RG59/6/7/11	128/5	Blister card

## ▶ 200-016 Wire Stripper Tool



Replacement blade :  
 900-117(6 pcs/pack)



Material		Application	Replacement blade	O.A.L. (mm/inch)	Individual packing
Body	Blade				
ABS		Wire(UTP/STP) or wire & multiconductor cable from Ø3.2-9mm(0.13"-0.35") max.	900-117 (6 pcs/pack)	112/4.4	Blister card

## ▶ 200-064 Multi-Function Wire Strippers



• Compact and lightweight design for easy operation.  
 • Provide multifunction for cutting and stripping RG-58/59/62 coaxial cable, flat telephone cable, 26-16 AWG precision wire.  
 • Blades are made for precision stripping and are quality built with carbon steel and finished with black oxide to prevent corrosion.

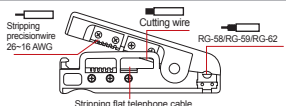

Material		Application	O.A.L. (mm/inch)	Individual packing
Body	Blade			
ABS		Stripping: RG-58/59/62 coaxial cable, 26-16 AWG(0.13~1.3mm <sup>2</sup> ) precision wire, flat telephone cable, cutting: 3.5~9mm <sup>2</sup> (12-8 AWG)	125/4.9	Blister card

## ▶ 902-229 Universal Stripping Tool



- Reversible stripping UTP/STP cable, flat telephone cable and coaxial cable with cutter function.



Replacement blade :  
 902-269  
 (4pcs/pack)

2 Blade Model  
 4/6/8/12 mm  
 0.16"/0.24"  
 0.31"/0.47"



Replacement blade cassette:  
 902-268  
 (1pcs/pack)



Material	Application	Replacement	O.A.L. (mm/inch)	Individual packing
ABS	Stripping UTP/STP twisted pair round cable, flat telephone cable, RG-59/11/7/6 coaxial cable	Blade: 902-269 Cassette: 902-268	125/4.9	Blister card

## ▶ 200-065 Rotary Coaxial Cable Stripper



- New design for stripping ethernet, thinnet RG-62/58/59/6 coaxial cable and other cable size. Each tool does 2 or 3 step strips with out any adjustment.



3 Blade Model  
 8 4 mm  
 Stripper Distance



Material	Application	O.A.L. (mm/inch)	Individual packing
ABS	Thinnet RG-62/58/59/6 coaxial cable and other cable size	108/4.3	Blister card

## ▶ 200-090 Coaxial Stripper



- Slot "A" for stripping center core.
- Slot "B" for stripping outer jacket. Rotating each by 3 to 5 times in clockwise direction (as arrow)
- Stripping cables by 2 steps.

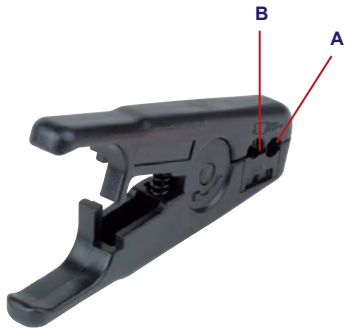

Model No.	Material		Application	O.A.L. (mm/inch)	Individual packing
	Body	Blade			
200-090	ABS		RG-58,59,62,6	100/4	Blister card

## ▶ 200-081 Rotary Coaxial Cable Stripper

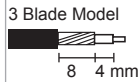

Stripper Distance



Replacement blade : 900-027(6pcs/pack)

Material	Application	Replacement blade	O.A.L (mm/inch)	Individual packing
ABS	For big cable O.D. around 10.5mm such as RG213	900-027 (6 pcs/pack)	105/4.1	Blister card

## ▶ 200-005 Rotary Coaxial Cable Stripper

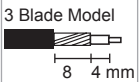

Stripper Distance

Material	Application	Replacement blade	O.A.L (mm/inch)	Individual packing
ABS	RG-58/59/62/3C/4C	900-027(6 pcs/pack)	107/4.2	Blister card

## ▶ 200-004 Rotary Coaxial Cable Stripper

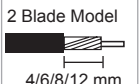

Stripper Distance



Replacement blade : 900-026(6pcs/pack)

Material	Application	Replacement blade	O.A.L (mm/inch)	Individual packing
ABS	RG-58/59/62/6/3C2V/4C/5C	900-026 (6 pcs/pack)	98.5/3.9	Blister card

## ▶ 200-084 Coaxial Stripper



- Clothespin design
- Strip configuration for RG6, 58 and 59
- Adjustable blades



Material		O.A.L.(mm/inch)	Individual packing
Blade	Body		
SK5	ABS	120/4.7	Blister card

## ▶ 200-051 Rotary Coaxial Stripper



Replacement blade : 900-027(6pcs/pack)

Material	Application	Replacement blade	O.A.L (mm/inch)	Individual packing
ABS	3-Blade model RG-59/62/6	900-027 (6 pcs/pack)	105/4.1	Blister card

## ▶ 200-050 Rotary Coaxial Stripper



Replacement blade : 900-027(6pcs/pack)

Material	Application	Replacement blade	O.A.L (mm/inch)	Individual packing
ABS	RG-59/62/6	900-027(6 pcs/pack)	105/4.1	Blister card

## ▶ 902-334 Rotary Coaxial Stripper



- Compact and lightweight design for stripping RG-174 coaxial cable easily.
- Made of ABS handle with SK5 blade.
- Rotary stripping, one-squeeze cutting action.
- Includes a small hex wrench in handle for blade depth adjustment.



Material	Application	Replacement blade	O.A.L (mm/inch)	Individual packing
ABS	Stripping RG-174 coaxial cable	902-334-BLADES	98.5/3.9	Blister card

## ▶ 902-323 Coaxial Cable Stripper



- For stripping RG-58, RG-59, RG-6 coaxial cable



Optional replacement cassettes: 902-324, 902-325, 902-326



Comes with 902-324 cassette

Model No.	Material		O.A.L.(mm/inch)	Individual packing
	Blade	Body		
902-323	SK5	ABS	120/4.7	Blister card

Model No.	Cassette color	Application
902-324	Red	3 Step strips for dual crimp N series connectors Strips braid 0.236 in. (6mm) and Dielectric 0.236 in. (6 mm)
902-325	Green	2 Step strips for twinax and UHF connectors Strips braid 0.480 in. (12mm)
902-326	Blue	2 Step strips for F-type and single crimp BNC/TNC connectors Strips braid 0.250 in. (6.35mm)

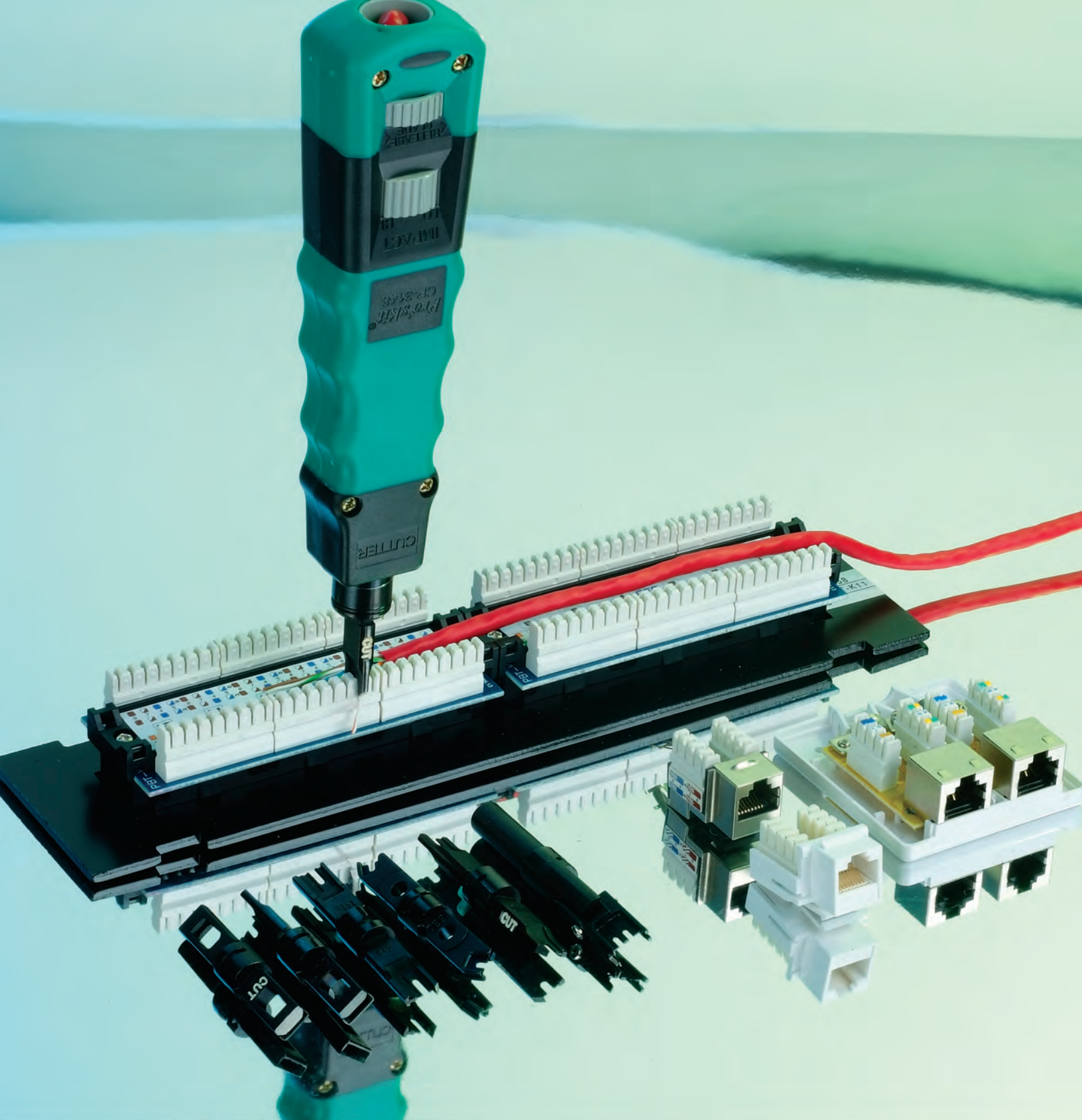

# PUNCHDOWN TOOLS



## ▶ 700-025/700-024 Mini Punchdown Tool



- Lid flips to allow storage of protective cap



Punch and cut cable terminals

**Economic Type**



Model No.	Material		Application	Standard blade type	O.A.L. (mm/inch)	Individual packing
	Blade	Body				
700-025	SNCM-21	Rubber (Anti-slip)	Fixed blade, not changable	66 (with cutter)	129/5.1	Blister card
700-024	SNCM-21	Rubber (Anti-slip)	Fixed blade, not changable	110 (with cutter)	129/5.1	Blister card

## ▶ 700-025-25/700-024-25 Mini Punchdown Tool

- Holds 25 pcs for retail display.



Model No.	Description
700-025-25	66 Blade Type in display jug shown at right
700-024-25	110 Blade Type in display jug shown at right

## ▶ CP-3145A Punchdown Tool



Punch and cut cable terminals



- Rotatable blade holder
- Blade on both ends



Material		Standard blade type	O.A.L. (mm/inch)	Individual packing
Blade	Body			
S45C	ABS	110/88 blade, one end with, one end without cut function	128/5.1	Blister card

## ▶ 900-140 Spudger

- Probe & Pick
- Tough nylon glass fiber construction
- Non-conductive - prevents shorting

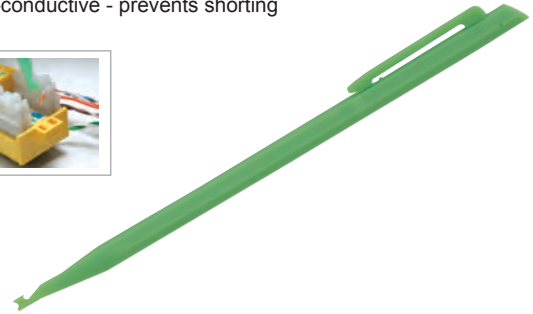

Material		O.A.L. (mm/inch)	Individual packing
Blade	Body		
Nylon+Fiber glass		142/5.6	Blister card

## ▶ 700-014/700-029 110 Punchdown Tool



- For use on LAN and telecom, seating 5 pairs or 4 pairs UTP (24 AWG) at a time.
- Suitable for both 110 type cable side and cross-connect side terminals blocks.
- The termination block head w/blades are changeable and reversible
- One end for seating and cutting off wires, and the other end for seating wires only.
- Patented: Taiwan.

700-018 (4 pairs) For 110 type	700-016 (5 pairs) For 110 type



Model No.	Material		Application	Standard blade type	Optional blade	O.A.L. (mm/inch)	Individual packing
	Blade	Body					
700-014	SNCM-21	T.P.R (Anti-slip)	Hi-low adjust pressure (Hi: 15±2kg, Low: 10±2kg)	110 (5 pairs)	700-016 700-018	140/5.5(w/o blade)	Blister card
700-029	SNCM-21	T.P.R (Anti-slip)	Hi-low adjust pressure (Hi: 15±2kg, Low: 10±2kg)	110 (4 pairs)		140/5.5(w/o blade)	Blister card

## ▶ CP-3147/CP-3148/CP-3150 Impact Punchdown Tool



- Ergonomic cushion grip with duplex color design.
- Spare blade storage chamber in handle.
- Increased HI/LOW forces to meet demands of all Category cables through Cat6.



Model No.	Material	Application	Standard Blade type	Optional blade	O.A.L. (mm/inch)	Individual packing
CP-3147	ABS + TPR	Hi-low adjust pressure (Hi: 40lbs 178N, Low: 30lbs /133N)	Handle Only (no blades)	700-008 700-009 700-015 700-017	162/6.4 (w/o blade)	Blister card
CP-3148			110/88 & 66 both ends cut only			
CP-3150			1pcs 110/88 & 1 pcs dual 66 with cut function			

## ▶ 700-007/700-010/700-011/700-012 Punchdown Tool

- Spring loaded impact
- Hi-Lo settings
- Spare blade storage in handle
- Blades/Handle inter-changeable with Harris Dracon and Fluke 814 tool and other industry standard tools



Model No.	Material	Application	Standard Blade type	Optional blade	O.A.L. (mm/inch)	Individual packing
700-007	ABS	Hi-low adjust pressure (Hi:15±2kg, Low:10±2kg)	Handle Only (no blades)	700-008 700-009 700-015 700-017	146/5.7 (w/o blade)	Blister card
700-010			w/110 & 66 Blades			Blister card
700-011			w/110 Blades			Blister card
700-012			w/66 Blade			Blister card

## ▶ 700-020/700-021/ 700-022/700-023 Impact Punchdown Tool



- A built-in combination hook/spudger for tracing and removing wires.
- Twist-lock style holder provides quick, easy blade changes and prevents pullout.
- An additional safe storage for one more spare blade



Model No.	Material	Application	Standard Blade type	Optional blade	O.A.L. (mm/inch)	Individual packing
700-020	TPR+PP (Anti-slip) (w/o Blade)	Hi-low adjust pressure (Hi:15±2kg, Low:10±2kg)	Handle Only (no blades)	700-008 700-009 700-015 700-017	168/6.6 (w/o blade)	Blister card
700-021			w/110 & 66 Blades			Blister card
700-022			w/110 Blades			Blister card
700-023			w/66 Blade			Blister card

## ▶ 700-027 Punchdown Tool-Locking Collar



Economic Type



Hex type	Model No.	For terminal block
	700-026	Dual 110/88 type, one end with cut function(Hex type)
	700-028	Dual 66 type, one end with cut function(Hex type)

Material	Application	Standard Blade type	Optional blade	O.A.L. (mm/inch)	Individual packing
ABS	Hi-low adjust pressure (Hi:15±2kg, Low:10±2kg)	110/88	700-026 700-028	186/7.3 (w/o blade)	Blister card

## ▶ 700-008/ 5CP-16A/ 700-009/ 700-015/ 700-017 Spare Blades

For CP-3147,CP-3148,CP-3150,700 series punchdown tools



700-008    5CP-16A    700-009    700-015    700-017

These five blades do not fit the 700-027 punchdown tool

Model No.	Material	For terminal block
700-008	SAE 4140	Dual 66 type, one end with cut function
5CP-16A	AISI 4140	66, 110/88 type, both ends with cut function
700-009	SAE 4140	Dual 110/88 type, one end with cut function
700-015	SAE 4140	Dual KRONE 110 type, one end with cut function
700-017	SNM-21	BIX, with cut function



# SOLDERING / ASSEMBLY

TWEZERS  
PRECISION PLIERS & CUTTERS  
ELECTRICAL PLIERS & CUTTERS  
KNIVES, SCISSORS & SAWS  
CRIMPERS  
STRIPPERS  
PUNCHDOWN TOOLS  
SOLDERING / ASSEMBLY  
SCREWDRIVERS/ BITS  
HEX KEY/ WRENCHES  
SOCKET WRENCHES  
TWEZERS

# SS-989A 2 In 1 SMD Hot Air Rework Station



With hot air and cool air functions

Quick replacement design for heater of heat gun



Soldering stand



SMD rework



Soldering Iron

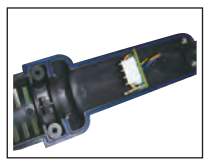

All around air-tight seal in hot air gun

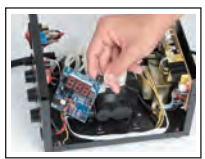

Only three screws, easy disassembly



High quality assembly

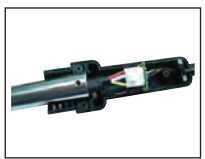

Connectorized design for quick change heater

### Features

- 2 In 1 rework station to save cost
- Closed circuit sensor design
- High power, quick warm up times
- Individual function start saves energy
- LED digital display
- Quiet operation
- Auto cool-off process to prolong the life of heating element
- ESD safe design
- Interchangeable and applicable to most of branded hot air nozzles and tips

Specification	
Model No.	SS-989A
Power Consumption	700W
Soldering Power	60W
Soldering Iron Temperature Range	200°C ~ 480°C (392°C ~ 896°F)
Hot Air Temperature Range	100°C ~ 450°C (212°C ~ 842°F)
Heating Element	Metal Heating Core
Pump/Motor Type	Diaphragm Pump
Air Capacity	24L/min (max)
Equipment noise	45dB
Temperature Display	LED
Power Input	110V 60Hz
Standard Plug	
Dimensions	330(L)x275(W)x195(H)mm 13" x 10.8" x 7.7"
Weight	3700g
Accessories	
Soldering Iron (60W)	110V x 1pcs
Hot Air Gun	110V x 1 pcs
Soldering Stand	1pcs
Nozzle	9SS-900-A1 (Ø2.2mm) x 1pcs 9SS-900-A2 (Ø6.6mm) x 1pcs 9SS-900-A3 (Ø8.5mm) x 1pcs
Individual packing	Color Box

### Replacement Tips:

Please refer to 5SI-216N series on page.80

### Replacement Nozzle:

IC Package	IC (mm/inch)	Model No.	AxB (mm/inch)	CxD (mm/inch)
Single 		9SS-900-A1	ø2.2 / .09(I.D)	
		9SS-900-A2	ø6.6 / .26(I.D)	
		9SS-900-A3	ø8.5 / .33(I.D)	
QFP (Quad Flat Pack) 	10x10 / .4x.4	9SS-900-B	10.2x10.2 / .4x.4	10x10 / .4x.4
	14x14 / .55x.55	9SS-900-C	15.2x15.2 / .6x.6	15x15 / .6x.6
	17.5x17.5 / .69x.69	9SS-900-D	19.2x19.2 / .76x.76	19x19 / .75x.75
	14x20 / .55x.79	9SS-900-E	15.2x21.2 / .6x.83	15x21 / .59x.83
	28x28 / 1.1x1.1	9SS-900-F	29.7x29.7 / 1.2x1.2	29x29 / 1.14x1.14
SOP (Small Outline Package) 	4.4x10 / 0.17x.4	9SS-900-H	10x4.8 / .39x.19	
	5.6x13 / .22x.51	9SS-900-I	15x5.7 / .59x.22	
	7.5x15 / .3x.6	9SS-900-J	16x7.2 / .63x.28	
PLCC (Plastic Leaded Chip Carrier) 	7.5x18 / .3x.71	9SS-900-K	19x7.2 / .75x.28	
	17.5x17.5 / .69x.69	9SS-900-L	18.5x18.5 / .73x.73	15x15 / .6x.6
	20x20 / .79x.79	9SS-900-M	21x21 / .83x.83	19x19 / .75x.75
	25x25 / .98x.98	9SS-900-N	26x26 / 1x1	24x24 / .95x.95
	30x30 / 1.18x1.18	9SS-900-O	31x31 / 1.2x1.2	29x29 / 1.1x1.1



## SS-969E SMD Rework Station



### Features:

- Microprocessor-controlled, closed circuit sensor design, high power and quick warm-up times
- Adjustable air flow, air volume and temperature, suitable for a variety of applications.
- Handle with sensor design provides real-time operating convenience.
- Auto cool-off process to prolong the life of heating element
- Plastic shell, compact body, attractive styling, and small footprint.
- Brushless motor design, quiet in operation, equipment noise less than 45dB
- Safe solder QFP, PLCC, BGA and other temperature-sensitive components.
- Also for heating shrink, viscosity removal, lacquer removal, preheating.

Specification	
Model No	SS-969E
Power Consumption	700W
Temperature Range	100~450°C(212~842°F)
Heating Element	Metal Heating Core
Equipment Noise	<45dB
Temperature Display	LED
Air Volume	120L / min (Max.)
Fuse type	250V / 10A
Input Voltage	110V
Plug Type	E
Machine Size	170mm x 170mm x 140mm 6.7" x 6.7" x 5.5"
Overall Package	280mm x 185mm x 170mm 11" x 7.3" x 6.7"
Weight	1.45 kgs
Accessories	
Heat Air Gun	110V x 1pcs (225 x 60 x 40mm / wire length 115cm) (8.9" x 2.4" x 1.6" / wire length 3' 9.3")
Nozzle	9SS-969-A1 x 1pcs ( ID: Ø 4.5mm/0.18" ) 9SS-969-A2 x 1pcs ( ID: Ø 7.5mm/0.3" ) 9SS-969-A3 x 1pcs ( ID: Ø 11.2mm/0.44" )
Individual packing	Color box



Standard nozzles x 3 pcs



SMD rework

## SS-611A Heat Gun Set



- Smart overheat protection design
- Automatic cool air flow to reduce waiting time from overheating shut down while working
- 2 temperature settings from 300°C~500°C for a variety of applications
- Dual color ergonomic grip and lightweight design provides greater comfort
- Includes 4 nozzles and 1 scraping tool with carrying case, easy to carry and store



Included 4 Nozzles + 1 Scraper



Paint and varnish removal

Voltage	Power	Dual temperature range	Case size (mm/inch)	Standard plug
120V 60Hz	I-750W II-1500W	I-300°C II-500°C	295x275x85 11.6" x 10.8" 3.3"	A

Individual packing: Color sleeve + shrink pack



### Caution:

- For safety, after using this product for one hour, please shut-off for 10 minutes to cool down temperature
- If this product is overheating after shut-off, the protection function will be coercively booted and shut this appliance off for 10 minutes. To prevent any overheating problem, never put the appliance down on its air outlet nozzle. Always keep its outlet nozzle upward or put it on one of its sides.

TWEEZERS  
PRECISION PLIERS & CUTTERS  
ELECTRICAL PLIERS & CUTTERS  
KNIVES, SCISSORS & SAWS  
CRIMPERS  
STRIPPERS  
PUNCHDOWN TOOLS  
SOLDERING / ASSEMBLY  
SCREWDRIVERS/ BITS  
HEX KEY/ WRENCHES  
SOCKET WRENCHES  
TWEEZERS

**SS-206E / SS-207E Temperature-Controlled Soldering Station**



- Modular Design for Quick Repair
- Lead Free Process
- Compact Size Design



**SS-206E**



(Soldering stand included)



**SS-207E**

**Features**

- Comply with CE, ESD safe certification.
- Adjustable temperature control with lock/set screw.
- Temperature range 200- 480°C (392-896°F).
- Made with an efficient ceramic heating element assuring a fast heating time.
- Soldering iron handles are insulated and ergonomically designed for ease and comfort.
- Celsius or fahrenheit temperature setting.
- Control IC modular design for easy and quick repair.



Modular design for easy repair (only for SS-207)



AC 110/220V switch

**Replacement tips: Pb-free**

OAL:43mm I.D.: 4.0mm O.D.: 6.3mm (OAL:1.7" I.D.: 0.16" O.D.: 0.25")

Model No.	SS-206E	SS-207E
Power consumption	60W	
Output voltage	24VAC	
Display	Analog	Digital
Heater	Normal Heater	
Temperature range	200°C- 480°C (392°F-896°F)	
Station Size	115mm x 95mm x 130mm 4.5" x 3.7" x 5.1"	
Voltage	AC 110V/220V switch	
Standard Plug	E (I) type	
Individual packing	Color Box	

	5SI-216N-B		5SI-216N-3.2D
	5SI-216N-B1.0		5SI-216N-1C
	5SI-216N-BC		5SI-216N-2C
	5SI-216N-0.8D		5SI-216N-3C
	5SI-216N-1.2D		5SI-216N-4C
	5SI-216N-1.6D		5SI-216N-I
	5SI-216N-2.4D		5SI-216N-K

## ▶ 900-066N 50W Soldering Station



Model No.	Voltage	Consumption	Temperature	Replacement heater:
900-066N	110~120V	50(W)	250~480°C (482~896°F)	902-174

Replacement heater	Standard plug	Station size LxWxH (mm/inch)	Individual packing
902-174		175x103x90(6.9x4.1x3.5)	Color Box

Replacement tip: (Offered by 5 pcs in a bag)

75° 1.44" R0.3 Ø.25"	900-073N	75° 1.44" R0.5 Ø.25"	902-132 (Standard)	75° 1.44" Ø.12" Ø.25"	902-134
75° 1.44" Ø.12" Ø.25"	900-074N	75° 1.44" Ø.04" Ø.25"	902-133	75° 1.44" Ø.16" Ø.25"	902-135

## ▶ SI-125A-15/SI-125A-20 Mini Soldering Iron

- Specifically for areas that require small size and fine application.
- Lightweight and triangle shape plastic handle for user comfort.
- Heats up fast but less wattage required.
- Tips screw on and off for easy changing.



Replacement tip:

.76" .16"	5SI-125T-B (Standard)
.76" .16"	5SI-125T-SB
.76" .16"	5SI-125T-D

Standard plug	OAL (mm/inch)	Individual packing
A	168/6.6	Blister card

Model No.	Voltage	Consumption	Temperature	Heater	Handle color
SI-125A-15	110-120V	15W	360°C±10%	Ceramic heater	Orange
SI-125A-20	110-120V	20W	410°C±10%	Ceramic heater	Orange

## ▶ 902-329 25W Soldering Iron



Replacement tip:

902-333 (Pencil type)

Voltage	Consumption	Temperature	Handle color	Standard plug	Individual packing
120V	25W	340°C	Black	A	Blister card

## ▶ 900-259 Mini Soldering Station



- Precision temperature control: ~330°C (~626°F)
- Super slim, pen-like style for greater control and visibility
- Specially designed for repairs to cell phones and PC boards
- Conductive soldering stand
- Dual voltage AC 110/220V



AC 110/220V Switch



Mini Ceramic Heater & Tip



Replacement tip:

	900-245
--	---------

Voltage	Consumption	Temperature	Standard plug	Individual packing
110V	4~14W	~330°C (~626°F)	E	Color box

## ▶ 900-035 20W~40W Soldering Station



- 20W-40W switchable solder station
- UL approved
- Comes with pencil tip



Replacement tip:

	900-036 (Chisel type)
	900-146 (Pencil type)

Voltage	Consumption	Temperature	Standard plug	Individual packing
110V	20~40W	400°C±30%	A	Color box

## ▶ 900-018N 30W Soldering Iron



- Converts easily from pen to gun configuration.
- When not in use handle covers tip for storage protection.



Replacement tip:

R0.5 .24" .4" .28" Ø.16"	900-020N (Pencil type)
--------------------------	------------------------

Voltage	Consumption	Temperature	Handle color	Standard plug	Individual packing
110~120V	30W	400°C±10%	Green / Black	E	Blister card

## ▶ GS-200K Gas Soldering Iron Kit-Auto Ignition

**Auto Ignition**



- Butane is easy to refill and check with see-through fuel window
- Auto ignition is easy to start and operate under any condition
- Adjustable flame control for precision use
- The kit includes, blow pen torch, protection cap, soldering head, needle soldering tip, 2.4mm soldering tip, double sharp tip, hot knife tip, hot air blower, polyfoam cutter, tube of solder, tip-cleaning sponge with safety stand and tool rest packed in rugged plastic case.



Hot air for SMD reworking      Torching      Soldering

Soldering temperature	Hot blow temperature	Torch temperature	Fuel cap.	Time	Size (mm/inch)	Individual packing
400 °C	500 °C	1300 °C	26 ml	100~120 min	220×Ø30 8.7×Ø1.2	Color box

## ▶ GS-520 Professional Torch

**CE** **Pb**

- Auto ignition is easy to start and operate under any condition
- Power butane blue torch flame.
- Anti-flare flame.
- Fingertip adjustable flame control.
- Child-resistant ignition for safety
- Includes detachable base for hands free work.

**Auto Ignition**

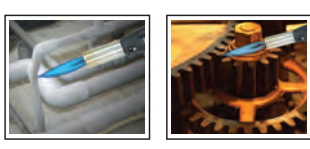

Torch temperature	Fuel cap.	Time	Size (mm/inch)	Individual packing
1300 °C	20 ml	60~90 min	130×73×155 / 5.1×2.9×6.1	Blister card

## ▶ GS-210 Professional Soldering Iron & Gas Torch

**Auto Ignition**

- Auto ignition is easy to start and operate under any condition
- Adjustable flame control for precision use
- Built-in stand for safety and easy placement during work
- Needle soldering tip and soldering head included
- Optional tips available for different applications



Soldering temperature	Hot blow temperature	Torch temperature	Fuel cap.	Time	Size (mm/inch)	Individual packing
370 °C	500 °C	1300 °C	7 ml	30~40 min	170×Ø 24 6.7×Ø.94	Blister card

## ▶ 900-004 ESD Mini-Desolder Pump

**Pb**



900-008

## ▶ DP-366D Desoldering Pump

**Pb**



5DP-366D-T

## ▶ DP-366P Desoldering Pump

**Pb**



5DP-366P-T

Model No.	Material	Suction Capability	Replacement Tip	OAL(mm/inch)	Individual packing
900-004	Aluminum	30cm-Hg	900-008	163/6.4	Blister card
DP-366D	ABS	32cm-Hg	5DP-366D-T	210/8.3	Blister card
DP-366P	ABS	40cm-Hg	5DP-366P-T	330/13.0	Blister card

## ▶ GK-368 Battery Operated Glue Gun



- Cordless design, free from A/C power cords and dangerous dangling cords.
- Convenience LED light allows for work in dark areas.
- Closed viewing window for easy glue stick checking, more constant temperature and dust free operation.
- For Ø7.5mm glue sticks
- Perfect for toys and models, corkboards, DIY projects, school projects, quick repairs around the house, decorations, wood crafts and more.



Power	Preheat time	Power source	Optional glue sticks	Running time
7W/6V	3-4 minutes	1.5V AA battery x 4 (not included)	Model No.: GK-67330-8, Ø7.5mm Glue Sticks, 8 pcs /pack	45 minutes (Alkaline type)

## ▶ 900-115 Glue Gun



- Solid state electric glue provides a fast, easy way to dispense hot melt adhesive for hundreds of fastening and repair jobs.
- Specially designed feed mechanism, spring-tensioned nozzle and silicone sleeve assure precise control of adhesive flow for neater work.



Decoration model and more...



Models

Voltage	Power	Preheat time	Flow of glue	Standard plug	Individual packing
120V	30-80W	10 min	14-16g per min	A (I)	Double blister

## ▶ 900-118A Glue Stick



- 6pcs per pack



## ▶ 902-227 Helping Hands Octopus Clamp Kit



- Maximum thickness of table or bench edge: 1.5"(40mm)
- Including magnifier arm x1, magnet arm x1, stayput arms x4
- Magnification: 2.5X

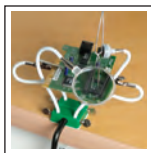

Multi function

Individual packing: Blister card

## ▶ 902-094 Helping Hands



- The practical helper for soldering work for electronics and model-making.
- Holding clamps adjustable in many ways, complete with magnifying glass 3.5"(90mm) dia: 2X.
- Sturdy stand.



Individual packing: Color box

## ▶ Helping Hands

900-037



900-206



900-015

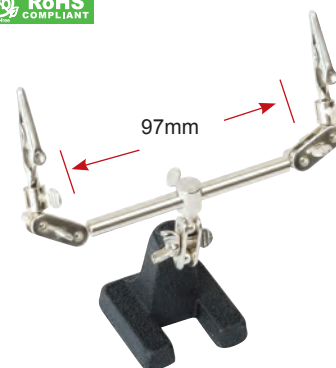

Model No.	Material			Magnification	Base OAL(mm)	Individual packing
	Magnifier	Arm	Base			
900-037	Acrylic	Low carbon steel	Cast-iron	Ø 50mm 6D(2.5X)	54x54x57	Color box
900-206	Glass			Ø 64mm 6D(2.5X)	54x54x32	
900-015	N/A			N/A	54x54x57	

▶ **900-016 Soldering Stand**



Individual packing: Color box

▶ **6S-2 Soldering Stand**

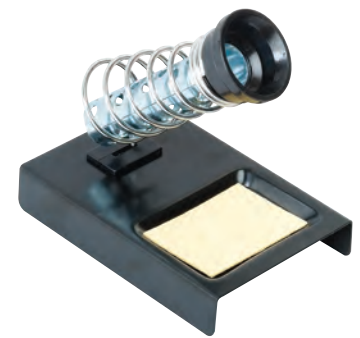

Individual packing: Color box

▶ **900-099 Soldering Stand**



Individual packing: Color box

▶ **902-095 Mini Soldering Stand**



- 2 position iron holder stand
- Built-in sponge tray



Individual packing: Color box( 2pcs / pack)

▶ **900-242/ 900-243 Soldering Tip Cleaner Replacement Tip Cleaner**



- No water necessary.
- Anti-slip pad.
- Made of low abrasive brass shavings.
- Cleans better than conventional sponges.
- No temperature drop as in conventional sponges.

Model No.	Description	Spec	Individual packing
900-242	Soldering tip cleaner	ø83 x 27mm/ 3.3" x 1.1	Blister card
900-243	Replacement tip cleaner	25g	Hanger (5 pcs/pack)

▶ **902-335 Cut To Size Soldering Sponge**



Material	Size(mm/inch)	Individual packing
Cellulose	100x110/3.9x7.8	Hanger (3 pcs/pack)

▶ **900-100 Solder Aid Tools**



- This kit contains specialized tools you need for soldering: Assisting rods for P.C.board soldering work.

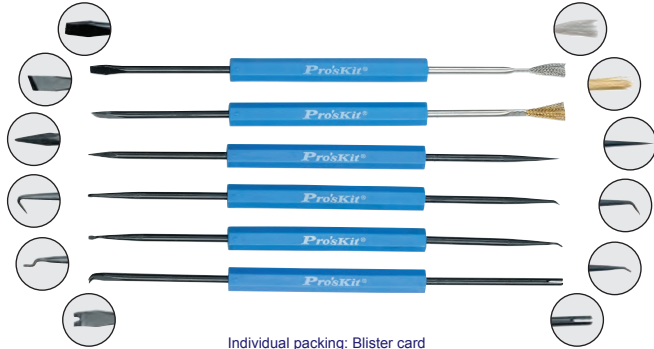

Individual packing: Blister card

▶ **900-250 Solder Aid Tools**



Individual packing: Blister card



# SCREWDRIVERS / BITS

# Screwdrivers/Bits

**Pro'sKit® screwdrivers with ergonomic handles , high quality blades and super hardened finished tips feature the maximum torque and user comfort.**

## Handle styles:

**Pro'sKit®** screwdrivers come in various handle styles to meet requirements of most applications, including PVC, ABS, dual color non-slip ABS&TPR, ESD safe, VDE 1000V insulated handles..

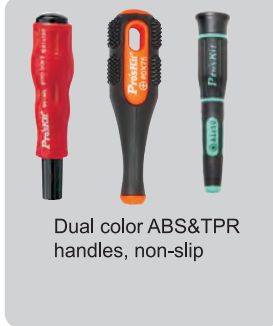

## Ratchet types:

**Pro'sKit®** screwdrivers have a variety of styles. Some come with ratchet mechanism design, and some are articulated handles. Ratchet screwdrivers require less force but more torque than conventional handles. It comes with 3 adjustable positions adjustment; forward, reverse rotation and fixed. The articulated handles allow adjustment of the reverse angle up to 180° for quick screwing, especially in narrow working spaces.



## Material of bits and blades:

**Pro'sKit®** screwdriver blades and bits are made from high grade steel to meet most of applications, including Chrome-Vanadium steel(Cr-V), Chrome-Molybdenum Vanadium steel(Cr-Mo-V), S2 alloy steel(S2). Tips with special hardened finish for perfect fit in screw slots and lasting durability.

## Black tip

Black tip with hardened finish guarantees a long service life and increased corrosion protection.

## Magnetic

Magnetic tip for greater fastener control and guarantees a perfect fit every time.

## Symbols for blade and bit shapes

**Pro'sKit®** screwdriver assortment with many bit specifications apply to most screws.

		Slotted			Spanner			Clutch			Wing nut driver
		Phillips			Phillips tamper proof			Pozidriv			Torq
		Torx®			Torx® tamper proof			Star			Spline
		Hex			Hex tamper proof			Ball hex			Nut
		Square			Square tamper proof			Triangle			TRI-wing
		Bihexagon socket			Square drive socket (for adapter)			Needle type bits			

\* Torx® is a trademark of Camcar Textron

**Safety Caution**  
• Don't use tools on live or energized circuits or equipment.



## SD-081 Series Precision Screwdriver



Model No.	Spec.	Blade length	Model No.	Spec.	Blade length	Model No.	Spec.	Blade length			
SD-081-S1	⊖	1.0	2"	SD-081-TRI1	⚙️	#1	2"	SD-081-M3	⦿	M3.0	2.8"
SD-081-S2	⊖	1.6	2"	SD-081-T1	⦿	T1	2"	SD-081-M3.5	⦿	M3.5	2.8"
SD-081-S3	⊖	2.0	2"	SD-081-T2	⦿	T2	2"	SD-081-M4	⦿	M4.0	2.8"
SD-081-S4	⊖	2.4	2"	SD-081-T3	⦿	T3	2"	SD-081-M4.5	⦿	M4.5	2.8"
SD-081-S5	⊖	3.0	2"	SD-081-T4	⦿	T4	2"	SD-081-M5	⦿	M5	2.8"
SD-081-S6	⊖	2.4	3"	SD-081-T5	⦿	T5	2"	SD-081-M5.5	⦿	M5.5	2.8"
SD-081-S7	⊖	3.0	3.9"	SD-081-T6	⦿	T6	2"	SD-081-M6	⦿	M6	2.8"
SD-081-S8	⊖	4.0	5.9"	SD-081-T7	⦿	T7	2"	SD-081-H1	⦿	0.7	2"
SD-081-P1	⊕	#000	2"	SD-081-T8	⦿	T8	2"	SD-081-H2	⦿	0.9	2"
SD-081-P2	⊕	#00	2"	SD-081-T9	⦿	T9	2"	SD-081-H3	⦿	1.3	2"
SD-081-P3	⊕	#0	2"	SD-081-T10	⦿	T10	2"	SD-081-H4	⦿	1.5	2"
SD-081-P4	⊕	#1	2"	SD-081-T15	⦿	T15	2"	SD-081-H5	⦿	2.0	2"
SD-081-P5	⊕	#0	3"	SD-081-T20	⦿	T20	2"	SD-081-H6	⦿	2.5	2"
SD-081-P6	⊕	#1	3.9"	SD-081-T5H	⦿	T5H	2"	SD-081-H7	⦿	3.0	2"
SD-081-P7	⊕	#1	5.9"	SD-081-T6H	⦿	T6H	2"	SD-081-Z1	⊕	#000	2"
SD-081-TA20	⚙️	2.0	2"	SD-081-T7H	⦿	T7H	2"	SD-081-Z2	⊕	#00	2"
SD-081-TA23	⚙️	2.3	2"	SD-081-T8H	⦿	T8H	2"	SD-081-Z3	⊕	#0	2"
SD-081-TA27	⚙️	2.7	2"	SD-081-T9H	⦿	T9H	2"	SD-081-Z4	⊕	#1	2"
SD-081-TRI000	⚙️	#000	2"	SD-081-T10H	⦿	T10H	2"	SD-081-TS1	⦿	TS1	2"
SD-081-TRI00	⚙️	#00	2"	SD-081-T15H	⦿	T15H	2"	SD-081-A1	⦿	A1	2"
SD-081-TRI0	⚙️	#0	2"	SD-081-T20H	⦿	T20H	2"	SD-081-A2	⦿	A2	2"

Individual packing: Blister card



## SD-081A 7 PC Electronic Set



Contents	
AISI 8660 Cr-Mo-V alloy steel with TPR Handle screwdriver X 7Pcs (OAL:147mm/5.8")	
⊖	1.6x2", 2.0x2", 2.4x2", 3.0x2"
⊕	#00x2", #0x2", #1x2"
Carrying case: 170x139x23mm/ 6.7"x5.5"x0.91"	

Individual packing: Plastic box + Color box

## SD-081G 4 PC TRI-wing Precision Screwdriver Set



Contents	
⚙️	SD-081-TRI000
⚙️	SD-081-TRI00
⚙️	SD-081-TRI0
⚙️	SD-081-TRI1

Individual packing: Blister card

TWEEZERS

PRECISION PLIERS

ELECTRICAL PLIERS & CUTTERS

KNIVES, SCISSORS & SAWS

CRIMPERS

STRIPPERS

PUNCHDOWN TOOLS

SOLDERING / ASSEMBLY

SCREWDRIVERS/ BITS

HEX KEY/ WRENCHES

SOCKET WRENCHES

TWEEZERS

## SD-083 ESD Precision Screwdriver



Pro'sKit Precision ESD Safe Screwdrivers are tested in accordance with ESD Association standard; meet the requirements for tools used in static sensitive areas. Surface resistance of handles is  $10^7 \sim 10^9 \Omega$



Model No.	Spec	Blade length (inch)
SD-083-S3	⊖ 2.0	2.0
SD-083-S4	⊖ 2.4	2.4
SD-083-S5	⊖ 3.0	3.0
SD-083-P2	⊕ #00	2.0
SD-083-P3	⊕ #0	2.4
SD-083-P4	⊕ #1	3.0
SD-083-T4	⊗ T4	3.0
SD-083-T5H	⊗ T5H	3.0
SD-083-T6H	⊗ T6H	3.0

Individual packing: Blister card

## SD-0839 ESD Precision Screwdriver Set

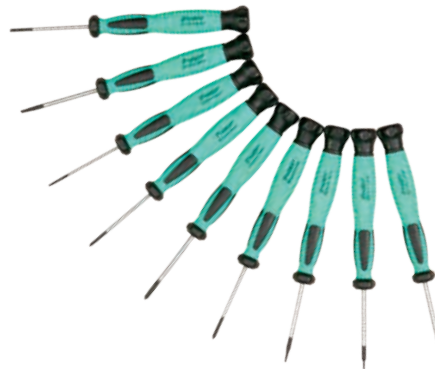

Contents	
⊕	SD-083-P2 SD-083-P3 SD-083-P4
⊖	SD-083-S3 SD-083-S4 SD-083-S5
⊗	SD-083-T4
⊗	SD-083-T5H SD-083-T6H

Individual packing: Pouch

## 800 Series Ceramic Driver

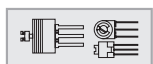

RF coils & trimmers

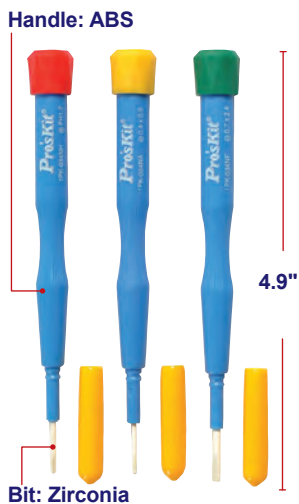

Model No.	Spec.
800-114	⊖ 0.4x0.9mm (0.015"x0.035")
800-115	⊖ 0.4x1.2mm (0.015"x0.047")
800-116	⊖ 0.4x1.4mm (0.015"x0.055")
800-117	⊖ 0.4x1.8mm (0.015"x0.070")
800-118	⊖ 0.4x2.0mm (0.015"x0.078")
800-119	⊖ 0.4x2.4mm (0.015"x0.094")
800-120	⊖ 0.7x2.4mm (0.027"x0.094")
800-121	⊕ PH0
800-122	⊕ PH1.7

Individual packing: Double blister

## 800-130 3 PC Anti-Static Alignment Tool Kit



- For protection of sensitive components
- Duplex, trimmer and square/hex tool
- Conductive nylon-avoid high voltage

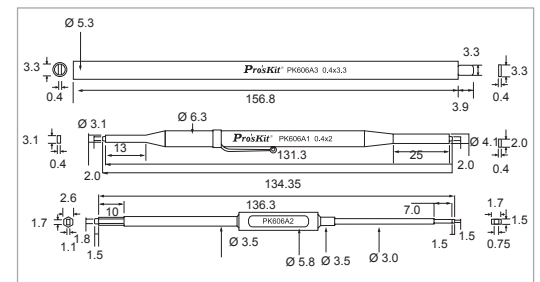

Conductive handle resistivity:  $10^6 \sim 10^{11}$



Material	Spec.
Conductive nylon	As sketch

Individual packing: Blister card

## 800-129 33 PC Screwdriver Set W/Bits



Contents	
TPR non-slip handle with bits holder	
30pcs 4mm hex x 28mm (1.12"), Material: AISI 8660 Cr-Mo-V steel	
+	PH000, PH00, PH0, PH1
-	SL1.0, SL1.5, SL2.0, SL2.5, SL3.0, SL3.5, SL4.0
•	T4, T5, T6, T7, T8, T9, T10, T15, T20
•	H0.7, H0.9, H1.3, H1.5, H2.0, H2.5, H3.0, H4.0
+	PZ1, PZ0
2 pcs ø4mm/ ø0.16" socket, material: AISI 6150 Cr-V steel	
•	Socket: M5, M6
Carrying Case: 170x139x23mm/ 6.7"x5.5"x0.9"	

Individual packing: Plastic box + Color Label



Adjustable length 1.4"~4.9"

## SD-081E 12 IN 1 Precision Screwdriver Set w/Bit



Contents	
TPR non-slip handle with bits holder	
12pcs 4mm hex x 28mm (1.12"), Material: AISI 8660 Cr-Mo-V steel	
-	SL2.0, 2.5, 3.0, 4.0
+	#000, #00, #0, #1
•	T6, T7, T8, T9
Carrying case: 134x65x25mm/ 5.3"x2.6"x1"	

Individual packing: Plastic box + Color box



## SD-9824 24-IN-1 Screwdriver Set

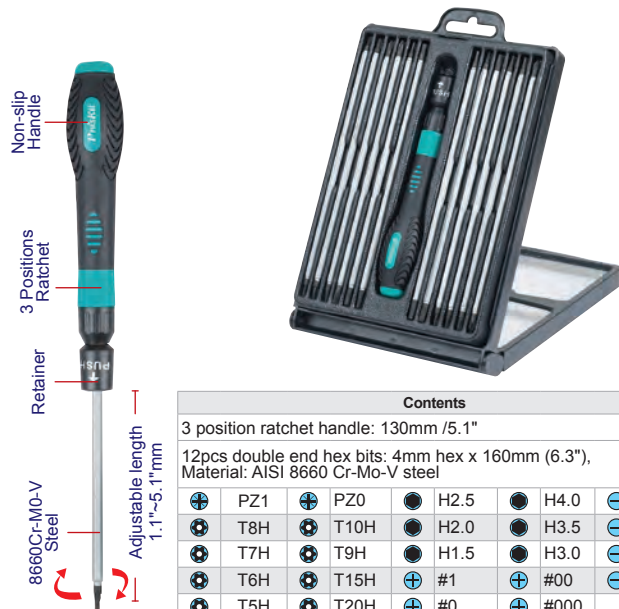

Non-slip Handle  
3 Positions Ratchet  
Retainer  
8660Cr-Mo-V Steel  
Adjustable length 1.1"~5.1"mm

Contents									
3 position ratchet handle: 130mm /5.1"									
12pcs double end hex bits: 4mm hex x 160mm (6.3"), Material: AISI 8660 Cr-Mo-V steel									
+	PZ1	+	PZ0	•	H2.5	•	H4.0	-	4.0
•	T8H	•	T10H	•	H2.0	•	H3.5	-	3.0
•	T7H	•	T9H	•	H1.5	•	H3.0	-	2.0
•	T6H	•	T15H	+	#1	+	#00	-	1.5
•	T5H	•	T20H	+	#0	+	#000		
Carrying Case :192x130x26mm /7.6"x5.1"x1"									

Individual packing: Plastic box + Color box

## SD-9312 14 PC Ratchet Precision Screwdriver Set



Soft touch  
Big rotary cap  
Elastomer resin double structure non-slip.  
Ratchet mechanism

Contents					
3 position ratchet handle: 135mm /5.3"					
10pcs hex bits: 4mm hex x 28mm /1.1", Material: AISI 8660 Cr-Mo-V steel					
+	#00, #0, #1	-	1.0, 1.5, 2.5	•	T5, T6, T7, T8
2Pcs socket: 4mm hex x32mm /ø0.16 x 1.3", Material: AISI 6150 Cr-V steel					
•	4.0, 5.0				
Extension blade: 120mm /4.7"					
Carrying case: 137x104x26mm /5.4"x4.1"x1"					

Individual packing: Color sleeve

## SD-9802 31 IN 1 Precision Electronic Screwdriver Set



- Smooth rotating cap for quick and easy screw/unscrew without lifting from screw
- Ergonomic design with non-slip and dual color TPR handle for operator comfort
- Keyless chuck for easy adjustment of bits holder extension bar
- Adjustable bit holder design for easy work inside narrow or hard to reach places
- A versatile set for driving and retrieving very small screws
- With bits holding storage box for bits managing and carrying

Contents			
TPR non-slip handle: 115mm/4.5"			
Extension bar :110mm /4.3"			
30pcs hex bits: 4mm hex x 28mm (1.1"), Material: AISI 6150 Cr-V steel			
+	PH00, PH0, PH1, PH2	•	0.9, 1.3, 1.5, 2.0, 2.5, 3.0, 4.0mm
•	T4, T5, T6, T7, T8, T10, T15, T20	+	2mm, Pin 1.0mm
-	1.5, 2, 2.5, 3, 3.5, 4mm	Extension bar: 110mm	
•	3mm, • 2.6mm, • 3mm	TPR non-slip handle:115mm/4.5"	
Carrying case: 205x126x34mm / 8"x5"x1.3"			

Individual packing: Double Blister



TPR handle  
Adjustable bits holder  
Adjustable length 46~115mm/ 1.8"~4.5"

(Storage box size: 212x142x30mm/ 8.3"x5.6"x1.2")

### SD-9326M Consumer Electronic Equipment Repair Kit



• Fits a variety of video games, smart phones, notebook brands.  
• Includes P2, P5, P6 pentalobe bits for Apple products.

**NEW**



Contents	
+	#1, #0, #00, #000
-	SL2.0, SL2.5, SL3.0, SL4.0
+	T4, T5, T6, T8, T10, T15, T20
+	H0.7, H1.5, H2.0, H3.0
+	TRI1, TRI0, TRI00
+	TA2.0
-	2.6mm
+	PZ0, PZ1
+	Pentalobe bits: P2, P5, P6
+	Pin for SIM card tray ejection

Non-slip Handle with Extension bar.  
Polyoxymethylene (POM) opening lever x 2, OAL:84.4, 88.7mm/3.3", 3.5"  
Prying paddle x1, suction cap Ø36mm x1,  
Solder aid tool x 1, double end metal spudger x1,  
Tweezer x1, reverse action tweezers x1  
Carrying case : 225x125x50mm /8.85"x4.9"x1.9"

### SD-9314 17 IN 1 Tool Kit For Apple Products



**RoHS COMPLIANT**



Contents	
+	Dual color precision screwdriver handle: 110mm /4.3"
+	12pcs 4mm precision screwdriver bits: 4mm hex x 28mm, material: AISI 8660 Cr-Mo- V steel
+	PH000, 1.5mm, T4, T5, T6, T8, T10, T15, T20
+	H2.0mm, H1.5mm
+	Needle type bits for iPhone / iPad SIM card tray ejection
+	Polyoxymethylene (POM) opening lever x 2 OAL: 84.4mm, 88.7mm / 3.3", 3.5"
+	Suction cup Ø36mm/Ø1.4"
+	Prying paddle 30.5x30.5x30.5mm / 1.2"x1.2"x1.2"

Individual packing: Plastic box + Sleeves + Shrink Carrying case :135x94x30mm /5.3"x3.7"x1.2"

### PK-9110 6 PC iPhone 3 & 4 Disassemble Set



**RoHS COMPLIANT**



Contents	
+	P2X40mm : OAL 91.5mm/3.6"
+	#000X40mm : OAL 91.5mm/3.6"
+	Polyoxymethylene (POM) opening lever x 2 OAL: 84.4mm, 88.7mm/3.3",3.5"
+	Suction cup Ø36mm/Ø1.4"
+	Prying paddle 30.5mm x 30.5mm x 30.5mm / 1.2"x1.2"x1.2"

Individual packing: Blister card

### SD-9313 30 IN 1 Video Game Screwdriver Set



Contents	
+	19pcs hex bits: 4mm hex x 28mm (1.1"), Material: AISI 8660 Cr-Mo-V steel
+	#000, #00, #0
+	2.0, 3.0, 5.0mm
+	T5H, T6H, T8H, T10H, T15H, T20H
+	T4
+	H0.7
+	TRI 1, TRI 0, TRI 00
+	1.7, 2.0, 2.3mm
+	5pcs hex bits: 1/4" x 25mm (1.0"), Material: SAE 6150 Cr-V steel
+	4.0, 5.0, 6.0mm
+	#1, #2
+	4pcs Nut & Torx plus socket, Material: SAE 6150 Cr-V steel
+	TS3.8, TS4.5(L:38mm/1.5")
+	6mm, 8mm (L:36mm/1.4")
+	3 position ratchet handle: 135mm /5.3"
+	Ø4mm to Ø1/4" adaptor: 45mm /1.8"
+	Extension bar: 115mm /4.5"
+	Carrying case : 205x126x34mm /8"x5"x1.3"

Individual packing: Color box

## SD-9315 22 In 1 Precision Screwdriver Set



- With extension bar design, ideal for accessing fasteners in tight areas
- Bits with color-coded for easy identification and management
- Durable compact size storage box for easy bits collection and carrying
- Ideal for mobile phone, PDA, PC & other applications.

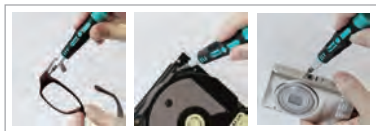

Ideal for mobile phone, PC, DIY home use & more



Contents		
● 2.5/3.0/3.5/4.0/4.5/5	⊕ PH1/PH0/PH00/PH000	4mm
● 1.0/1.5/2.0/2.5/3.0	⊖ T4/T5/T6/T7/T8	
Extension bar: 4mm x 70mm		
1pc Dual color PP+TPR handle		
Carrying case: 130x86x29mm/5.1"x3.38"x1.1"		

Individual packing: Blister Card



## SD-9316 23 In 1 High Performance Screwdriver Set



- Bits with color-coded for easy identification and management
- Durable compact size storage box for easy bits collection and carrying
- Ideal for mobile phone, PDA, PC & other applications.



Ideal for mobile phone, PC, DIY home use & more



Contents			
● H2/H3/H4/H5	1/4"	⊕ PH1/PH0/PH00	4mm
● T15H/T20H/T25H		● 1.5/2.0/2.5	
● 6/8/10		● T4/T5/T6/T7	
Extension bar: 4mm x 70mm, 1/4" x 70mm			
1pc Anodized aluminum alloy handle			
Carrying case: 130x86x29mm/5.1"x3.38"x1.1"			

Individual packing: Blister Card



## SD-9804 15 IN 1 Precision Electronic Screwdriver Set



- Ergonomic designs with non-slip and dual color TPR handle for operation comfort.
- 14pcs interchangeable precision bits made of high quality chrome vanadium steel.
- With extension bar design, ideal for accessing fasteners in tight areas
- Durable compact size box in dual colors for easy storing and carrying.

Contents	
TPR non-slip handle: 110mm	
Extension bar: 110mm	
14pcs hex bits: $\phi 4 \times 28$ mm, Material: AISI 6150 Cr-V steel	
⊕ #000, #00, #0, #1	
● 1.5, 2.0, 2.5, 3.0, 4.0mm	
● T5, T6, T7, T8, T9	
Carry case: 147x95x24mm/5.8"x3.7"x0.9"	

Individual packing: Blister card

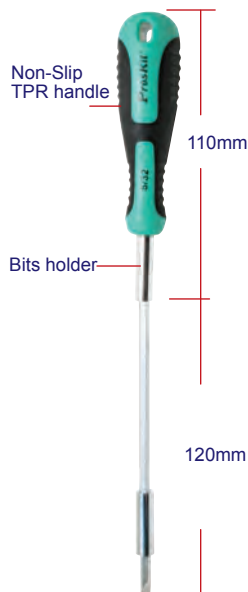

### ▶ SD-9608 30 PC Aluminum Handle Precision Screwdriver Set



**NEW**



- Aluminum handle with rubber grip provides user comfort
- Linkage structure of bits tray for easy bits change and storage
- Covering most common use bits in a compact box
- Compact box with hanger design for easy carrying and storage

Contents		4 mm bits
PH000,PH00,PH0,PH1	1.0,1.2,1.5,1.8	
PZ000,PZ00,PZ0,PZ1	0.7,0.9,1.3,1.5,2.0	
T4,T5,T6,T7	TS1	
3.0, 3.0, 2.0mm		
2.6 S0, Needle Type bits 1.0mm		
Extension bar : 4mm x 70mm(2.76")	Aluminum alloy handle	
Carrying case : 148x74x28mm/5.8"x2.9"x1.1"		

Individual packing: Color box

### ▶ 800-060 20 PC Precision Electronic Screwdriver Set



This useful set contains slotted / phillips / star / hex / ball point / blades. Special quick-release design, makes blade change quickly and easily.

Contents	
19pcs bits: 4mm hex x 28mm/1.1", Material: AISI 8660 Cr-Mo-V alloy steel	
#00, #0	
2.0, 2.5, 3.0, 4.0	
T6, T7, T8, T9, T10	
1.5, 2.0, 2.5	
PZ#00, PZ#0	
1.5, 2.0, 2.5	
Handle: 163mm/6.42" (OAL)	

Individual packing: Plastic box + Color box

### ▶ 500-041 9 PC Cellular Kit



Contents	
9pcs screwdrivers: 146mm/5.7" Material: AISI 8660 Cr-Mo-V steel	
T4	
T5H, T6H, T7H, T8H	
1.9, 2.9	
#00	
TR11	
Carrying case: 205x126x34mm/8.1"x5"x1.3"	
Individual packing: Shrink	

### ▶ 500-024 7 PC Cellular Phone Tool Kit



Contents	
7pcs screwdrivers: 140mm/5.5" Material: AISI 8660 Cr-Mo-V steel	
#0,	
T5, T6, T7,	
Back panel opener	
Folding cover opener	
Security screwdriver	
Carrying case:	170x132x21mm / 6.7"x2.5"x0.8"
Individual packing:	Plastic box+Color box

### ▶ 800-073 15 PC Precision Screwdriver Set



- Blade length: 40mm/1.6"
- Overall length: 132mm/5.2"

Contents	
1.0, 2.0, 3.0, 3.5	1.5, 2.0, 2.5, 3.0
#000, #00, #0	T6, T8, T10, T15
Carrying case: 262x183x43mm/10.3"x7.2"x1.7"	

Individual packing: Plastic box + Color label

### ▶ 902-222 11 PC Cellular Phone Maintenance Tool Kit



Contents	
2.0mm	T6, T7, T8H
#0	5mm
T-Grip holder	Antenna repair tool
Pressing blade	Panel pry bar
Carrying case: 133x97x20mm/5.2"x3.8"x0.8"	

Individual packing: Plastic box + Color label

## SD-9814 9 IN 1 Aluminum Handle Precision Screwdriver Set



Contents	
Anodized aluminum alloy steel handle: 110mm/4.3"	
9pcs hex bits: 4mm hex x 28mm/1.1", Material: AISI 6150 Cr-V steel	
+ #000, #00, #0, #1	
- 2.0, 3.0mm	
● T4, T5, T6	

Individual packing: Blister card



## SD-9812 12 IN-1 Reversible Ratchet Precision Screwdriver Set



- Transparent PC handle with 6 double-end precision bits inside
- Adjustable blade lengths, good for hard to reach areas
- Ratchet action with 3 positions: Forward, reverse and lock
- Retainer lock system prevents the end cap from accidental slip damage

Contents			
3 position ratchet handle with bits holder : 155~205mm/6.1"~8.1"			
6pcs double end bits: 4mm hex x 30mm/1.2", Material: AISI 8660 Cr-Mo-V steel			
●	T4	●	T8
●	T6	●	T10
●	T7	●	T15
●	1.5	●	#000
●	2.0	●	#00
●	2.5	●	#0

Individual packing: Blister card

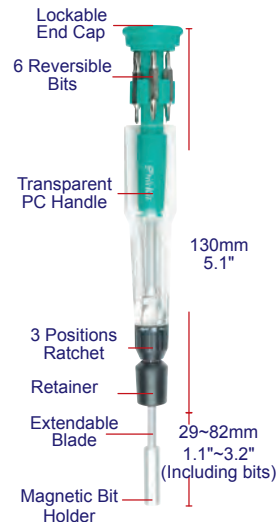
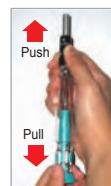

## SD-9815 Precision Screwdriver Set



Bit size	A (mm)	B (mm)	OAL (mm)	
+	#0	29	76	105
+	#1	31	81	112
●	1.4mm	18	63	81
●	1.8mm	25	68	93
●	2.4mm	29	75	104
●	3.0mm	31	81	112

Carrying case: 135x85x22mm

Individual packing: Color box

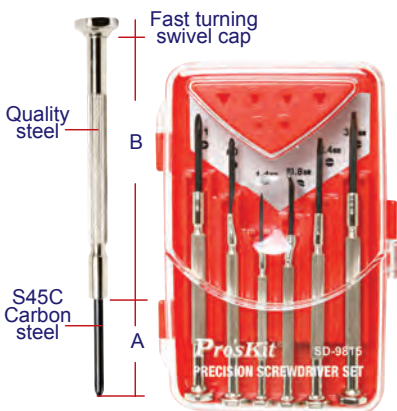

## SD-9819 Precision Screwdriver Set



- Ideal for precision working such as repairing eyeglasses, cameras, watches, hobbies, electronic devices and more

Economic Type



Bit size	A (mm)	B (mm)	OAL (mm)	
+	#0	26	71	97
+	#1	28	80	108
●	1.4mm	21	62	83
●	1.8mm	25	66	91
●	2.4mm	26	71	97
●	3.0mm	28	80	108

Carrying case: 129x70x18mm

Individual packing: Color box



## SD-9811 18-IN-1 Precision Screwdriver Set



Contents		Bit length		
Aluminum handle: 90mm				
9pcs double end screwdriver bits: 52mm, Material: AISI 8660 Cr-Mo-V steel				
●	1.5	+	#000	52mm/2.2"
●	2.0	+	#00	52mm/2.2"
●	2.5	+	#0	52mm/2.2"
●	3.0	+	#1	52mm/2.2"
●	T5	●	T10	52mm/2.2"
●	T6	●	T8	52mm/2.2"
●	T7	●	T9	52mm/2.2"
●	H1.5	●	H2.5	52mm/2.2"
●	H2.0	●	H1.3	52mm/2.2"

Carrying case: 114x136x26mm

Individual packing: Plastic box + Color box

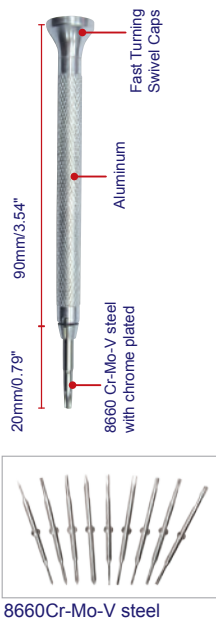

8660Cr-Mo-V steel

## 902-219 58-piece Precision Electronic Screwdriver Set



- Non-Magnetic for precision working application.
- Light weight designed (285g/set)

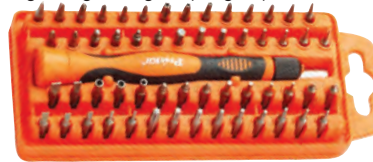

Contents	
TPR non-slip handle: 123mm/4.8"	
Extension bar: 115mm/4.5"	
56Pcs hex bits: 4mm hex x 28mm/1.1", Material: AISI 8660 Cr-Mo-V steel	
+ #000, #00, #0, #1	
● 1.0mm, 1.5mm, 2.0mm, 2.5mm, 3.0mm, 3.5mm, 4mm	
● T5H, T6H, T7H, T8H, T9H, T10H, T15H, T20H	
● T3, T4, T5, T6, T7, T8, T9, T10, T15	
● 1.5mm, 2mm, 2.5mm, 3mm, 1/16", 5/64", 3/32"	
● 2mm, 2.3mm, 2.5mm	
● 0.7mm, 0.9mm, 1.3mm, 1.5mm, 2mm, 2.5mm, 3mm, 4mm 0.028", 0.035", 0.05", 1/16", 5/64", 3/32"	
+ PZ0, PZ1	
● TR1	
● 2mm	

Carrying case: 175x73x39mm/6.9"x2.9"x1.5"

Individual packing: Shrink pack + Color sleeve





## Precision Screwdriver

### Features:

- Rotating cap to facilitate support and rotation control.
- The handle is made by durable ABS material with anti-slipstrip for easy operation.
- Blade made of high quality alloy Ni-Cr-Mo steel, heat-treated and black.

Unique finger-tip control handle with a fine-adjustable rotary cap.



105mm/4.1"

20mm/0.78"

Chrome-molybdenum vanadium steel with black finish.

## 800-007 6 PC Precision Screwdriver Set



- A 6 piece screwdriver set with 3 flat blades and 3 Philips screwdrivers.
- The screwdrivers have long shafts and are ideal for reaching recessed screws in electronic equipment.
- Handles are made from molded plastic and incorporate finger grips.
- Shafts are made from nickel chrome molybdenum.

Contents	Blade length (mm/inch)
⊕ #0 (Ø 2.4)	75/3.0
⊕ #1 (Ø 3.0)	100/3.9
⊕ #1 (Ø 3.8)	150/5.9
⊖ 2.4mm	75/3.0
⊖ 3.0mm	100/3.9
⊖ 3.8mm	150/5.9

Individual packing: Blister card

## 800-149 Screwdriver Set



Contents	Blade length (mm/inch)
⊕ #0, #00, #1	20 mm/0.78
⊖ 2.0, 2.4, 3.0	20 mm/0.78

Individual packing: Color box

## 800-009 6 PC Precision Screwdriver Set



Contents	Blade length (mm/inch)
⊕ #000	40/1.6
⊕ #00	75/3.0
⊕ #0	75/3.0
⊖ 0.08	40/1.6
⊖ 0.10"	75/3.0
⊖ 0.12"	75/3.0

Individual packing: Plastic box + Color label

## SD-3102 Screwdriver Set



Contents	Blade length (mm/inch)
⊕ T4	20 mm/0.78
⊕ T5H, T6H, T7H, T8H, T9H	20 mm/0.78

Individual packing: Color box

## 800-077 6 PC Electronic Screwdriver Set With Cutter



Contents	Blade length (mm/inch)
⊕ #1	150/5.9
⊕ #0	100/3.9
⊕ #0 (Ø 2)	75/3.0
⊖ 2.4mm	75/3.0
⊖ 3.0mm	100/3.9
⊖ 4.0mm	150/5.9

3.5" Stainless micro cutting plier

Individual packing: Plastic box + Color label

## 800-150 Screwdriver Set



Contents	Blade length (mm/inch)
⊕ T5H, T6H, T7H, T10H, T15H, T20H	20 mm/0.78

Individual packing: Color box



## SD-9810A/SD-9810A-BC 10 in 1 Auto Loading Ratchet Screwdriver Set



- Precision screwdriver features 3 ways gearless ratchet with twist reverse for efficient operation.
- Pump-action design for easily and quickly auto-loading bits exchange.
- Ergonomically non-slip handle provides user comfort
- Rotatable marked barrel for 6pcs bits pre-loading and storage.
- Includes ten high quality AISI 8660 Cr-Mo-V alloy steel bits with satin finish.

**10 in 1  
Change bits  
in seconds**



OAL:170mm/6.7"



4pcs bits storage in PC handle

ABS Ergonomically non-slip handle

6pcs bits storage in rotatable marked barrel

170mm  
6.7"

3 way gearless ratchet:  
forward, reverse and locked

Magnetized 4mm Bits Holder

AISI 8660 Cr-Mo-V steel  
HRC:55°±3°

Available only in 25pcs display box SD-9810A-BC

Contents	
10 pcs 4mm Hex screwdriver bits	
⊖	1.5, 2.0, 3.0
⊕	#00, #0, #1
⊗	T5, T6, T8, T10
Model No.	Individual packing:
SD-9810A	Color box (25pcs/box)
SD-9810A-BC	Single pc



## 800-092/800-092-50 4-In-1 Screwdriver Set



- Offered in 50PC in a display pack and blister pack (individually)
- Two double-ended, reversible tips
  - Material: Blade: AISI 6150 Cr-V steel
  - HRC: 52°±3°
  - Handle: ABS



## SD-804/SD-804-1 5-In-1 Screwdriver With LED Flashlight



- Offered by 50PCS in a display - box
- Two double-ended, reversible tips
  - Material: Blade: AISI 6150 Cr-V steel
  - LED light • HRC: 52°±3°
  - Handle: ABS



Model No.	Individual packing	Contents	O.A.L (mm/inch)
800-092	Single pc	⊖ 1/16", 1/8" ⊕ #00, #0	131/5.2"
800-092-50	50 pcs display pack	Display box: 213x123x144mm/8.4"x4.8"x5.7"	

Model No.	Individual packing	Contents	O.A.L (mm/inch)
SD-804	50 pcs display pack	⊖ 1/16", 1/8" ⊕ #00, #0	135/5.3"
SD-804-1	Blister card	Display box: 213x123x144mm/8.4"x4.8"x5.7"	

## 800-040 Double-ended Screwdriver



- Pocket clip
- Straight blade on long end
- Phillips on short end



Contents	
⊖	3mm
⊕	#0

Individual packing: Hanger

## 8PK-6182 9 In 1 Electronic Screwdriver Set



- | Contents  |                      |
|---|----------------------|
| TPR non-slip handle: 115mm                              |                      |
| 9Pcs hex bits:ø4 x 50mm, Material: AISI 6150 Cr-V steel |                      |
| ⊗   | T5, T6, T7, T8       |
| ⊖   | 2.0                  |
| ⊕   | #0                   |
| Back panel opener                                       |                      |
| Folding cover opener                                    |                      |
| ⊖   | Security screwdriver |
| Carrying case: 104x60x30mm/ 4.1"x2.4"x1.2"              |                      |

Individual packing: Color label



115mm  
(4.5")

39mm  
(1.5")

## 800 Series Soft-Handled Screwdrivers



Molded propylene handle

High grade chrome vanadium steel

Satin finish and black oxide tip

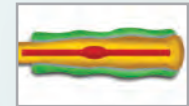

Special inlaid blade insert; safe and durable



Model No.	A	B(mm)	C	D	E
800-001	3	3.2	3.3	1/8	6.3
800-003	3	5.0	4.3	3/16	7.3
800-010	4	3.2	3.3	1/8	7.3
800-012	6	3.2	3.3	1/8	9.3
800-005	2.3	6.0	6.0	1/4	8.3
800-014	4	5.0	4.3	3/16	8.3
800-020	10	5.0	4.3	3/16	14.3
800-022	4.3	6.0	6.0	1/4	10.3
800-024	6.3	6.0	6.0	1/4	12.3
800-018	8	5.0	4.3	3/16	12.3
800-016	6	5.0	4.3	3/16	10.3
800-026	8.3	6.0	6.0	1/4	14.3

Individual packing: Hanger

Model No.	A	B	C	D	E
800-002	3	#0	3.3	1/8	6.3
800-004	3	#1	4.3	3/16	7.3
800-011	4	#0	3.3	1/8	7.3
800-013	6	#0	3.3	1/8	9.3
800-006	2.3	#2	6.0	1/4	8.3
800-015	4	#1	4.3	3/16	8.3
800-021	10	#1	4.3	3/16	14.3
800-023	4.3	#2	6.0	1/4	10.3
800-025	6.3	#2	6.0	1/4	12.3
800-019	8	#1	4.3	3/16	12.3
800-017	6	#1	4.3	3/16	10.3
800-027	8.3	#2	6.0	1/4	14.3

Individual packing: Hanger

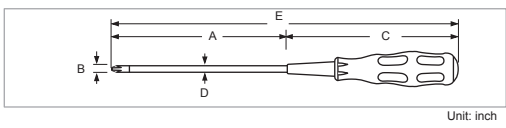

Unit: inch

### Star-Tip with Tamper-proof holes (Larger sizes)

Model No.	A	B	C	D	E
800-032	2	T5	3.3	5/32	5.3
800-033	2	T6	3.3	5/32	5.3
800-034	2	T7	3.3	5/32	5.3
800-035	3	T8	3.3	5/32	6.3
800-036	3	T9	3.3	5/32	6.3
800-037	3	T10	3.3	5/32	6.3
800-038	3	T15	3.3	5/32	6.3
800-043	2	T7H	3.3	5/32	6.3
800-044	3	T8H	3.3	5/32	6.3
800-045	3	T9H	3.3	5/32	6.3
800-046	3	T10H	3.3	5/32	6.3
800-047	3	T15H	3.3	5/32	6.3

Individual packing: Hanger

### Tri-wing Type Screwdriver

Model No.	A	B	C	D	E
800-123	2	TRI	3.3	1/8	5.3

Individual packing: Blister card



Molded propylene handle

High grade chrome vanadium steel

Satin finish and black oxide tip

## SW-2125H 5 PC Star Screwdriver Set



**Contents**  
 T05H, T06H, T07H, T08H, T09H  
 Individual packing: Blister card

## 800-030 11 PC Star Screwdriver Set



**Contents**  
 T6, T7, T8, T9, T10, T15, T20, T25, T27, T30, T40  
 Carrying case: 310x230x50 mm  
 12.2"x9.1"x2"

Individual packing: Inner box + Color label shrink

## SD-2800 Series Dual Color Grip Nut Driver



- Dual color, ergonomic cushion grip handles for maximum comfort.
- The handle is molded directly onto the blade for permanent bonding.
- Heavy duty deep head blades, hardened for maximum torque and wear resistance
- Precision heads for accurate fastener fit, chrome plated anti corrosion finish
- Handle end comes with screw type mark for easy identification



Dual color PP+TPR cushion grip handle

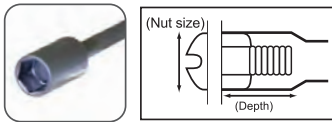

Model No.	Nut size (mm) & depth(mm)	Blade length	OAL
SD-2800-I1	3/16 x 1"	4.9"	9.3"
SD-2800-I2	5/32 x 0.12"	4.9"	9.3"
SD-2800-I3	9/32 x 1"	4.9"	9.3"
SD-2800-I4	7/32 x 1"	4.9"	9.3"
SD-2800-I5	11/32 x 1"	4.9"	9.3"
SD-2800-I6	1/2 x 1"	4.9"	9.3"
SD-2800-I7	7/16 x 1"	4.9"	9.6"
SD-2800-I8	1/4" x 1"	4.9"	9.6"
SD-2800-I9	5/16" x 1"	4.9"	9.3"
SD-2800-I11	3/8" x 1"	4.9"	9.3"

Individual packing: Double blister card



Chrome plated anti corrosion finish

Material: AISI50BV30 Boron steel

Heavy duty deep head blade

TWEEZERS

PRECISION PLIERS & CUTTERS

ELECTRICAL PLIERS & CUTTERS

KNIVES, SCISSORS & SAWS

CRIMPERS

STRIPPERS

PUNCHDOWN TOOLS

SOLDERING / ASSEMBLY

SCREWDRIVERS/ BITS

HEX KEY/ WRENCHES

SOCKET WRENCHES

TWEEZERS

## 1PK-9402 7 PC Electronic Hex Nut Driver Set

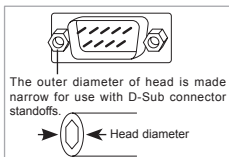

The outer diameter of head is made narrow for use with D-Sub connector standoffs.

Head diameter

### Contents

M3, M3.5, M4, M4.5, M5, M5.5, M6

Individual packing: Pouch



## 8PK-2066 Interchangeable Screwdriver Set (7 PC)



- Shock proof cellulose acetate plastic handle with circuit testing lamp.
- Range: AC 100~250V.

Contents	
Circuit testing handle, length: 120mm	
6 Pcs bits, length: 125mm material: AISI 8660 Cr-Mo-V Alloy steel	
⊖	3x130
⊕	5x130
⊕	No.1x130
⊕	No.2x130
⊕	5.5x130
⊕	AWLx130

Individual packing: Plastic box+Color label



**SD-800 Series 1000V Insulated VDE Screwdrivers** **SD-800-18/19/111 Insulated VDE Nut Driver**



- Certified to IEC 60900: 2004, VDE, and DIN 1000V safety standards and bear the GS sign.
- High visibility molded ergonomic cushion grip handles for maximum comfort.
- The insulation of the handle is molded directly onto the blade for permanent bonding.



High visibility molded ergonomic cushion grip handles

Heavy insulated shank

AISI 8660 Cr-Mo-V alloy steel  
HRC:55'±2'

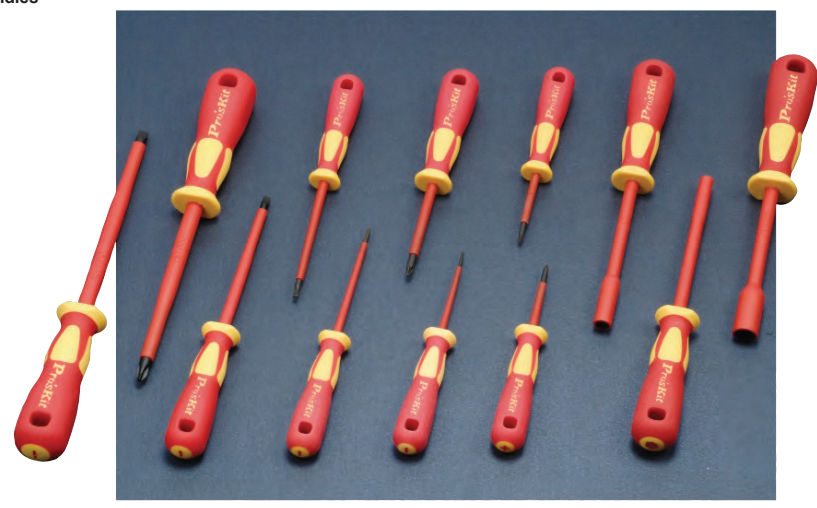

Dual color PP + TPR ergonomic cushion grip handles

Heavy insulated shank

Heavy duty deep head blade

Model No.	Spec.	Blade length (mm/inch)
902-212	⊖ 0.4x2.5mm	75/3
SD-800-S3.0	⊖ 0.5x3.0mm	100/4
902-214	⊖ 0.8x4.0mm	100/4
SD-800-S5.5	⊖ 1.0x5.5mm	125/5
902-216	⊖ 1.2x6.5mm	150/6
902-217	⊖ 1.2x8.0mm	175/7
902-209	⊕ PH0	60/2.4
902-210	⊕ PH1	80/3.2
902-211	⊕ PH2	100/4
902-220	⊕ PH3	150/6

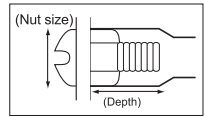

Model No.	Nut size (mm) & depth(mm)	Blade length (mm/inch)
SD-800-18	⊖ 1/4" x 1"	125/4.9
SD-800-19	⊖ 5/16" x 1"	125/4.9
SD-800-111	⊖ 3/8" x 1"	125/4.9

Individual packing: Double blister card

**902-213 Insulated Screwdrivers Set**

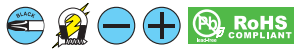

- 7 piece set. VDE safety screwdriver set with Cr-Mo-V alloy.
- Steel AISI: 8660 blade.
- This essential kit is a must when working with electrical items.
- Supplied in a case.

Contents
S2.5, S3.0, S5.5, S6.5,
Carrying case : 310x230x50mm 12.2"x9.1"x2.0"

Individual packing:  
Inner box+Color label shrink

## 902-215 8 PC 1000V Insulated Screwdriver & Plier Set



Contents	
⊖	0.4x2.5x75mm (3")
⊖	0.5x3.0x100mm (4")
⊖	1.0x5.5x125mm (5")
⊕	PH1x80mm (3.1")
⊕	PH2x100mm (4")
	6.3" Insulated wire stripping plier
	6.3" Insulated side cutter
	6.3" Insulated long nose plier
	Zippered carrying bag

- Case size: 255x175x50/10.0x6.9x2.0 (mm/inch)
- Individual packing: Inner box & Color label shrink



## 902-218 11 PC 1000V Insulated Plier & Screwdriver Set



Contents	
⊖	0.4x2.5x75mm (3")
⊖	0.8x4.0x100mm (4")
⊖	1.0x5.5x125mm (5")
⊖	1.2x6.5x150mm (6")
⊕	PH0x60mm (2.4")
⊕	PH1x80mm (3.1")
⊕	PH2x100mm (4")
	7.9" Insulated combination plier
	6.3" Insulated side cutter
	7.9" Insulated long nose plier
	6.3" Insulated long nose plier
	Zippered carrying bag

- Case size: 294x240x50 / 11.6x9.4x2.0(mm/inch)
- Individual packing: Inner box & Color label shrink



## 902-099 6 PC Insulated Precision Screwdriver Set



- Provides shock protection to 1000V AC
- Meet VDE standards for safety to 1000V AC
- Comes complete with a plastic storage case
- Material (Blade): Cr-Mo

Contents	O.A.L.(mm/inch)
⊖ 0.4x2.0x65mm(2.6")	165/6.5"
⊖ 0.23x1.5x65mm(2.6")	165/6.5"
⊖ 0.4x2.5x65mm(2.6")	165/6.5"
⊕ PH00x65mm(2.6")	165/6.5"
⊕ PH0x65mm(2.6")	165/6.5"
⊕ PH1x65mm(2.6")	165/6.5"

Carrying case : 195x184x28mm/ 7.7"x7.2"x1.1"

Individual packing: Shrink



## SD-2400 Series Spanner Type Security Screwdrivers



Made of AISI 8660 Cr-Mo-V steel with Cr plating for antirust HRC:55 ±2°

- Made of Cr-Mo-V steel with chromium (Cr) plating for anti-rust
- Special inlayed blade molded into dual color TPR and PP non-slip handle provides high torque and user comfort.
- Fast turning swivel cap for easy operation.

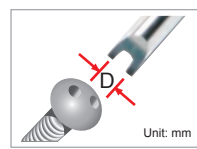

Model No.	D	OAL (mm/inch)
SD-2400-S4	1.5mm	186/7.3
SD-2400-S6	2.3mm	186/7.3
SD-2400-S8	2.5mm	186/7.3
SD-2400-S10	3.1mm	186/7.3
SD-2404	Contents: 4pcs Security Screwdriver Set. SD-2400-S4, SD-2400-S6 SD-2400-S8, SD-2400-S10	

Individual packing: Blister card

## SD-7213 Series Go Through Screwdrivers

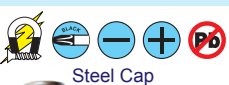

The hex shaft and bolster fit any brand of wrench which can loosen tight screws easily.



The steel cap withstands hammer blows

- "Go-Through" construction provides greater striking force than traditional cap end.
- The hex shaft and bolster fit any brand of wrench which can loosen tight screws easily.
- Black oxide magnetic tip for greater fastener control and guarantees a perfect fit every time.



**Toughest Ergonomic More turning power**

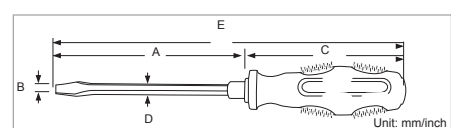

Model No.	A (mm/inch)	B	C (mm/inch)	D (mm/inch)	E (mm/inch)
SD-7213A	150/5.9	6.0mm	109/4.3	6/0.23	259/10.2
SD-7213B	150/5.9	#2	109/4.3	6/0.23	259/10.2
SD-7222A	150/5.9	8.0mm	121/4.8	8/0.31	271/10.7
SD-7222B	150/5.9	#3	121/4.8	8/0.31	271/10.7



Individual packing: Hanger

## 902-096/902-097 Pro-soft Screwdriver Set



Elastomer resin fitting exactly and double structure. Non-slip.

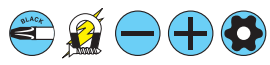

Model No.	Contents
902-096	3.0x75mm(3"), 5x75mm (3"), 6x100mm (4") #0x75mm(3"), #1x75mm(3"), #2x100mm(4")
902-097	T5HX50mm(2"), T6HX50mm(2"), T7HX50mm(2"), T8HX50mm(2") T9HX50mm(2"), T10HX75mm(3"), T15HX75mm(3")

Individual packing: Color box

## 800-028/800-029 Stubby Screwdrivers



Exact fit to screws and high accuracy hardened finish.

Model No.	Contents
800-028	6.0x40mm (1.6")
800-029	#2x40mm (1.6")

## ▶ 800-041/800-042 Pocket Clip Screwdriver

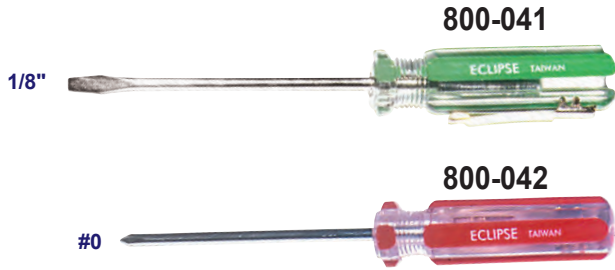

Model No.	Spec.
800-041	⊖ 3x135mm (5.31")
800-042	⊕ #0x135mm (5.31")

Individual packing: Hanger

## ▶ 800-148 Double-end Reversible Screwdriver

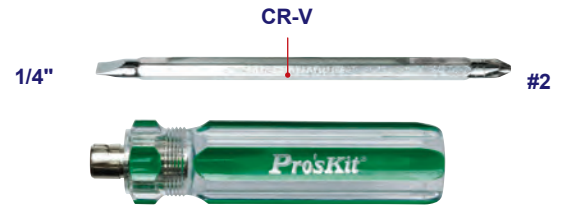
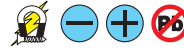

Material	HRC	Handle (mm/inch)	Blade (mm/inch)	Working length (mm/inch)
AISI 6150	48 ±3°	108/4.3	125/4.9	100/39"

Individual packing: Blister card

## ▶ SW-9109D 10 In 1 Double End Reversible Screwdriver Set

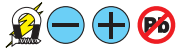

Contents			
1pcs PVC handle with , 1/4" bits holder, length: 100mm/3.9"			
6 bits, material: AISI 6150 Cr-V, HRC 52°±2°			
⊕ #2	⊖ 6.0	Length: 110mm/4.3"	⊕ #2
⊕ #2	⊕ #2	Length: 110mm/4.3"	⊕ #1
⊕ #2	⊕ #2	Length: 65mm/2.6"	⊕ #2
			⊕ #2

## ▶ 800-074 Ratcheted Screwdriver Handle



- Ratcheting
- Swiveling
- Reversible
- Heavy-duty rubber grip
- Your bits can be stored in handle holder



Individual packing
Blister card

## ▶ 800-080 6 In 1 Magnetic Quick Change Screwdriver

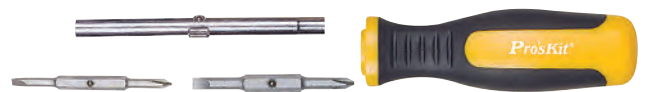

- Industrial quality with maximum versatility.
- Shock proof T.P.R + P.P. and S2 alloy steel bit.
- O.A.L: 200mm/7.9"

Contents	
Dual color TPR non-slip handle 125mm/4.9"	
3pcs double end bits and socket:	
⊖	8mm socket x115mm/4.5"
⊖	6mm socket x115mm/4.5"
⊖	3/16", 1/4" x75mm/3.0"
⊕	#1, #2 x75mm/3.0"

Individual packing: Blister card



Flash interchangeable



Double ended socket

## ▶ 8PK-SD010 12-In-1 Ratchet Screwdriver Set



Bits holder For holding screw

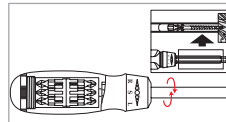

Contents	
Dual color TPR non-slip ratchet handle	
12pcs ø1/4"x30mm bits:	
⊖	T6, T7, T8, T9, T10, T15
⊕	#0, #1, #2
⊖	3, 4, 7, 6, 3

Individual packing: Blister card



Bits holder.

Ergonomic TPR+PP handle for user comfort.

Easy to adjust reversing collar.

Plastic tube for holding screw easily

Magnetic bits holder for easy of positioning

Made of S2 alloy steel

O.A.L:230mm

### ▶ SD-2318M 27 PC 1/4" Drive Socket & Screwdriver Set



- 72 teeth 2-way ratchet stainless steel handle for easy rotating operation
- Mini size gets into smaller and tighter spots easily
- Bits come with color ring for easy specification identification
- Covers most common use bits and sockets
- EVA tray complied with RoHS standard
- Compact box with hanger design for easy carrying and storage

Sockets meet DIN standard



Contents	
5pcs 1/4" Drive socket:	6, 7, 8, 10, 12mm
18pcs 1/4" Bits:	3.0, 4.0, 5.0, 6.0mm #1, #2, #3 PZ1, PZ2, PZ3 H3.0, H4.0, H5.0, H6.0 T10, T15, T20, T25
Magnetic Bit Adaptor: 60mm(L) / 2.4"	
1pcs 1/4" Hex(male) to 1/4" socket(male) adaptor 1/4" square drive(female) to 1/4" hex bit holder 1/4" 72 Teeth stainless reversible ratchet handle	
Carrying case: 84x39.5x129mm/3.3"x1.6"x5.1"	

Individual packing: Blister card

### ▶ SD-2319M 22 PC Palm Ratchet Wrench Bit & Socket Set

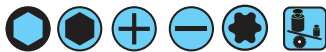

- Faster than a ratcheting wrench, the palm ratchet for easy operate in limited areas
- Combine with ergonomic aluminum handles provides maximum speed and torque
- Compact size, durable plastic box for easy carrying and storage
- Covering most common use bits and sockets to meet most applications



Aluminum handles provides maximum speed and torque



The palm ratchet for easy operate in limited areas

Contents	
5pcs 1/4" Drive socket:	5, 6, 7, 8, 10mm
14pcs 1/4" Bits:	3.0, 4.0, 6.0mm #1, #2, #3 H2.5, H3.0, H4.0, H5.0, H6.0 T10, T15, T20
1/4" Hex(male) to 1/4" socket(male) adaptor	Extension handle for palm ratchet
1/4" Drive aluminum palm ratchet	Carrying case 126x82x30mm/ 5.0"x3.2"x1.2"

Individual packing: Blister card

### ▶ 800-048/800-048E 33 PC Security Bit Set

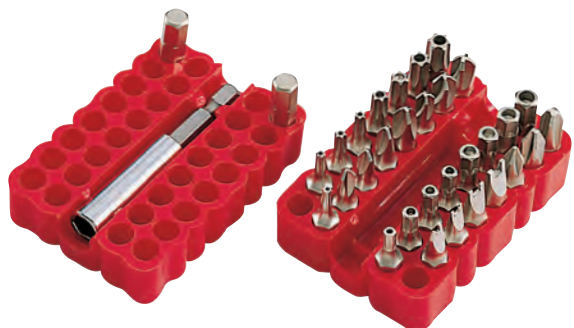

- Available in lower quality SAE 6150 CR-V steel for a lower price-part#: 800-048E
- 800-048 Material: S2 alloy steel bits

Contents	
1/4" Magnetic extension bar 60mm/2.4"	
32pcs 1/4" hex x30mm(1.2") bits	
Spec.	Spec.
5/64", 3/32", 7/64", 1/8", 9/64", 5/32", 3/16", 1/4"	4, 6, 8, 10 6, 8, 10
T8H, T10H, T15H, T20H, T25H, T27H, T30H, T35H, T40H	1, 2, 3, 4 1, 2, 3, 4

Individual packing: Blister card



## ▶ 800-068 Twin Wrench Driver Set



SAE-6150



Contents	
Both end handle 110mm/4.3"	
10pcs 4mm hex x30mm/1.2" AISI 6150 Cr-V steel bits:	
⊖ 4, 5, 6	
⊕ #1, #2	
⊕ PZ1, PZ2	
⊕ T10, T15, T20	



Design with tips at both ends for horizontal and vertical use.

Individual packing: Blister card

## ▶ 902-069 Twin Wrench Driver Set



SAE 6150

T6 to T30H have tamper proof holes for preventing tampering for cordless telephones and wireless equipment.



Contents	
Both end handle 110mm/4.3"	
8pcs $\phi 1/4$ "x30mm/1.2" AISI 6150 Cr-V steel bits:	
⊕ T6	
⊕ T8H, T10H, T15H, T20H, T25H, T27H, T30H	
2pcs $\phi 1/4$ "x37mm/1.5" AISI 6150 Cr-V steel double end bits:	
⊕ #1 - ⊖ 4.5	⊕ #2 - ⊖ 6.0



Design with tips at both ends for horizontal and vertical use.

Individual packing: Blister card

## ▶ 800-078 17 PC Offset Ratchet & Socket Drivers Set



2-way ratchet design for forward and reverse rotation.

Contents	
1pcs 2-way ratchet handle,	
6pcs sockets( $\phi 1/4$ " x 25mm/1", AISI 6150 Cr-V):	
⊕ 3/8", 11/32", 5/16", 1/4", 7/32", 3/16" (Inch size)	
10pcs bits( $\phi 1/4$ " x30mm/1.2", AISI 6150 Cr-V):	
⊖ 4, 5, 6mm	⊕ #1, #2
⊕ PZ1, PZ2	⊕ T10, T15, T20



Double end design and a direction switch for clockwise or counter-clockwise.

Individual packing: Blister card

## ▶ 800-076 Flexible Ratchet Driver Set



Contents	
10pcs $\phi 1/4$ "x30mm/1.2" AISI 6150 Cr-V steel bits:	
⊖ 4, 5, 6	
⊕ #1, #2	
⊕ PZ1, PZ2	
⊕ T10, T15, T20	
Flexible shaft (190mm/7.5")	Mini ratchet handle



Flexible shaft gets into hard to reach areas.

Individual packing: Blister card

## ▶ SD-9701M 20 IN 1 T-handle Driver Sockets & Bits Set

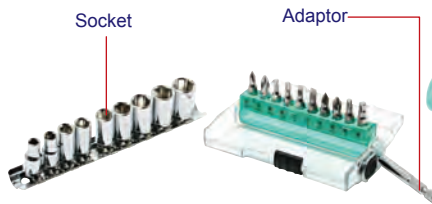

T handle, provides no stress on fingers

Green: PP  
Black: TPR

Magnetized carbon steel bits holder for 1/4" bits

Contents	
TPR non-slip T handle with bits holder (182mm/7.2")	
10Pcs hex bits: $\phi 1/4$ " x 25mm/1", Material: SAE 6150 Cr-V steel	
⊕ #1, #2	⊕ PZ1, PZ2
⊖ 4.0, 5.0mm	⊖ 4.0, 5.0mm
⊕ T15, T20	
9 pcs $\phi 1/4$ " DR.Socket bits, Material: SAE 6150 Cr-V steel 5,6,7,8,9,10,11,12,13mm	
⊕ 5,6,7,8,9,10,11,12,13mm (3/16", 1/4", 9/32", 5/16", 11/32", 3/8", 7/16", 1/2", 9/16")	
50mm Adaptor	
Carrying case: 115x55x17mm/4.5"x2.2"x0.67"	

Individual packing: Blister card

## ▶ SD-2313 30 PC Do-It-All Kit



- Triangle magnetic bits storage case with a hanger.
- Magnetic extension handle.
- Compact and versatile set of bits.



Magnetic storage case



Triangle bits case

Bits	
TPR non-slip handle with bits holder 30Pcs hex bits: $\phi 1/4$ " x 25mm/1", Material: SAE 6150 Cr-V steel	
⊕ SQ1, SQ2	
⊕ #0, #1, #2, #3	
⊕ PZ0, PZ1, PZ2, PZ3	
⊖ SL3.5, 4.5, 5.5, 6, 8mm	
⊖ HX2, 2.5, 3, 4, 5, 6, 8	
⊖ T5, T6, T7, T8, T10, T15, T20, T35	

Individual packing: Hanger

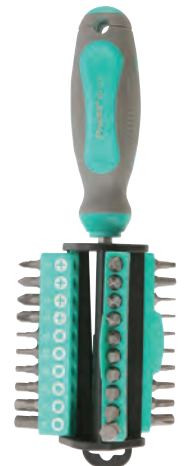

TWEEZERS  
PRECISION PLIERS  
ELECTRICAL PLIERS & CUTTERS  
KNIVES, SCISSORS & SAWS  
CRIMPERS  
STRIPPERS  
PUNCHDOWN TOOLS  
SOLDERING / ASSEMBLY  
SCREWDRIVERS/ BITS  
HEX KEY/ WRENCHES  
SOCKET WRENCHES  
TWEEZERS

### SD-2307M 35 PC 1/4" DR Socket & Screwdriver



Materials: SAE 6150 Cr-V Steel  
Light weight design: 733g



Contents	
<b>11 pcs 1/4" DR sockets:</b>	
● 4mm, 5mm, 5.5mm, 6mm, 7mm, 8mm, 9mm, 10mm, 11mm, 12mm, 13mm	
<b>20 pcs 4mm hex x 25mm bits:</b>	
⊕ #0, #1, #2, #3	⊖ 3mm, 5mm, 7mm
● 2.5mm, 3mm, 4mm, 5mm, 6mm, 8mm	
● T10, T15, T20, T25, T30, T40	
⊕ PZ2	
1 pcs ratchet handle 1/4" DR	1 pcs bit holder
1 pcs handle driver	1 pcs 1/4" x 2" extension bar
Case: 253x76x42mm/10"x3"x1.7"	

Individual packing: Color sleeve + Shrink pack

### SD-2308M 35 PC 1/4" DR Socket & Screwdriver W/Long Nose Plier Set



Materials: SAE 6150 Cr-V Steel  
Light weight design: 902g

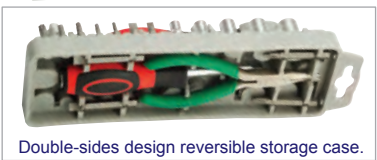

Double-sides design reversible storage case.



Contents	
<b>11 pcs 1/4" DR sockets:</b>	
● 4, 5, 5.5, 6, 7, 8, 9, 10, 11, 12, 13mm	
<b>12 pcs bits:</b>	
⊕ PH1, PH2, PH3	⊖ 3, 4, 5, 6mm
● T10, T15, T20, T25, T30	
<b>4 pcs 50mm bit</b>	
⊕ PH2, PH3	⊖ 6, 7mm
2 pcs ext bar 1/4"x3" , 1/4"x6"	
1 pc ratchet handle	
1 pc bit holder	
1 pc 1/4" x 1/4" universal joint	
1 pc long nose plier (135mm/5.3")	
1 pc 1/4" DR adjustable T-bar	
1 pc handle driver	

Case: 225x70x71mm/8.9"x2.8"x2.8"  
Individual packing: Color sleeve + Shrink pack

### 800-081 62 PC Security Bit Set



Materials: SAE 6150 Cr-V Steel  
Light weight design: 575g

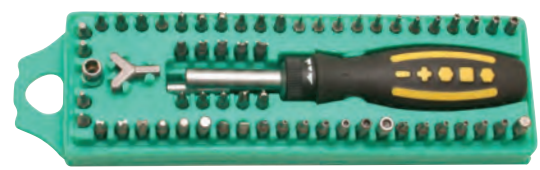

Contents		
● M5, M6, M8	⊖ C1, C2, C3	⊕ 6, 8, 10
⊖ 1/8", 3/16"	⊕ TA2.0	⊖ 4, 6, 8, 10, 12
● S0, S1, S2, S3	⊕ 1, 2, 3, 4, 5	⊕ PZ0, PZ1, PZ2
⊕ #0, #1, #2	⊖ Wing nut driver	
● T-5H, T-6H, T-7H, T-8H, T-9H, T-10H, T-15H, T-20H, T-25H, T-27H, T-30H, T-40H		
● 2, 2.5, 3, 4, 5, 6, 8mm, 5/64", 3/32", 7/64", 1/8", 9/64", 5/32"		
1 pc socket adapter		1 pc 1/4" x 60mm(2.36") magnetic bits holder
1 pc bits holder socket		1 pc ratchet screwdriver (190mm/7.5")

Case: 256x80x43mm/10.1"x3.1"x1.7"  
Individual packing: Shrink packing

### SD-2310 100 PC Assorted Power Bits Set



Materials: SAE 6150 Cr-V Steel  
Light weight design: 699g

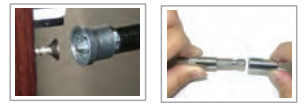

Contents		
<b>96 pcs bits:</b>		
⊕ PH1, PH2	⊕ PH0, PH1, PH2, PH3	
⊖ C1, C2, C3	● S0, S1, S2, S3	
⊕ 1, 2, 3, 4, 5	⊕ 6, 8, 10	
⊕ PZ0, PZ1, PZ2, PZ3	⊕ TA2.0	
● M5, M6, M8	⊖ 2, 3, 5mm	
⊖ 4, 6, 8, 10, 12	⊖ Wing nut driver	
● 1.5mm, 2mm, 2.5mm, 3mm, 4mm, 4.5mm, 5mm, 5.5mm, 6mm, 7mm, 8mm, 1/16", 5/64", 3/32", 7/64", 1/8", 9/64", 5/32", 3/16", 7/32", 1/4"		
● 2, 3, 4, 5, 6, 7, 8mm, 5/64", 3/32", 7/64", 1/8", 9/64", 5/32", 3/16", 7/32", 1/4"		
● T5H, T6H, T8H, T10H, T15H, T20H, T25H, T27H, T30H, T35H, T40H		
● T5, T6, T8, T10, T15, T20, T25, T27, T30, T40		
1 pc sockets adapter		1 pc bits holder
1 pc dry wall stopper		1 pc magnetic bit holder

Individual packing: Color sleeve + Shrink pack



# HEX KEY WRENCHES

▶ **800-124/800-066 7 PC Folding Hex Key Set**

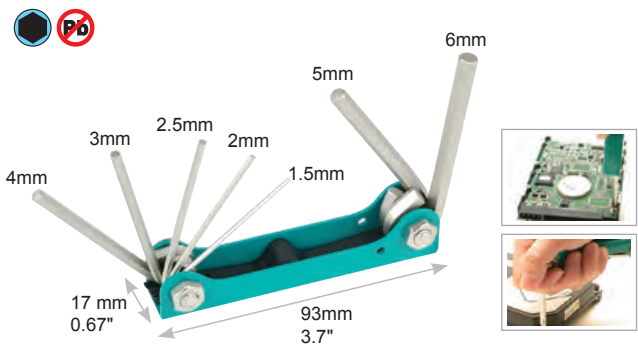

Model No.	Contents	
800-124	● 1.5, 2, 2.5, 3, 4, 5, 6mm (Metric size)	
800-066	● 1/16", 5/64", 3/32", 1/8", 5/32", 3/16", 1/4" (Inch size)	
Key Material	Case	Individual packing
SAE6150 with Satin finish	Green lacquered	Blister card

▶ **800-052 8 PC Folding Star Key Set**

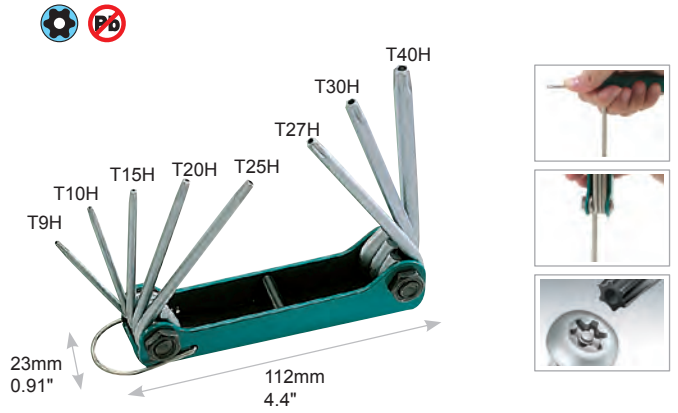

Contents		
● T9H, T10H, T15H, T20H, T25H, T27H, T30H, T40H		
Key Material	Case	Individual packing
SAE 8660 with Satin finish	Green lacquered	Blister card

▶ **902-100 8 PC Folding Star Key Set**

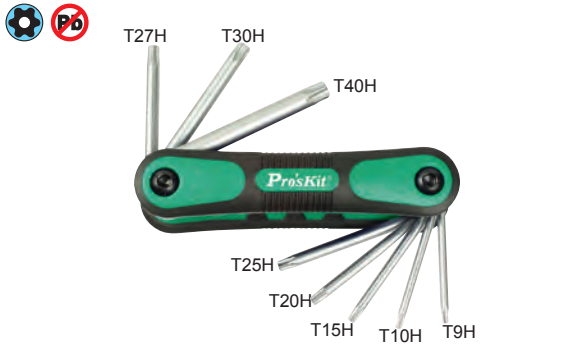

Contents			
● T9H, T10H, T15H, T20H, T25H, T27H, T30H, T40H			
Key Material	Case	OAL (mm/inch)	Individual packing
SAE 6150 with Satin finish	T.P.R. Anti-slip	109x43x23 4.3"x1.7"x1"	Hanger

▶ **902-226 9 PC Folding Hex Key Set**



Contents		
● 5/64", 3/32", 7/64", 1/8", 9/64", 5/32", 3/16", 7/32", 1/4" (Inch size)		
Key Material	Case	Individual packing
SAE 6150 with Satin finish	T.P.R. Anti-slip	Hanger

▶ **HW-928 1/2" T-Handle Hex Key**

- Long reach design with T-handle for greater torque and ease of use
  - Hardened S2 steel alloy
- Individual packing: Hanger

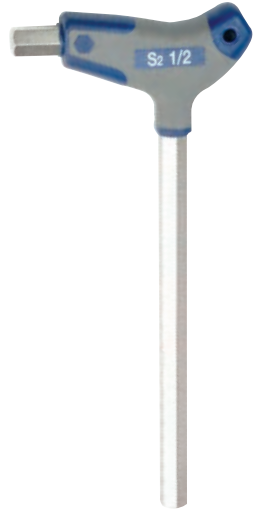

▶ **800-091 7 PC T-Handle Hex Key Set**

- Long reach design with T-handle for greater torque and ease of use
  - Hardened S2 steel alloy
  - Set comes in a durable blow-molded case
  - 3/32", 1/8", 5/32", 3/16", 1/4", 5/16" and 3/8"
- Individual packing: Shrink wrap



## ▶ HW-229B 9 PC Ball Point Long Arm Hex Key Set

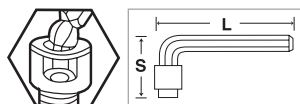

Tip size(mm)	S (mm/inch)	L (mm/inch)
1.5	15.5/0.61	63.5/2.5
2	18/0.71	76/3.0
2.5	20.5/0.81	85.5/3.4
3	23/0.91	91/3.6
4	29/1.1	102/4.0
5	33/1.3	118/4.6
6	38/1.5	139/5.5
8	44/1.7	155/6.1
10	50/1.9	177/6.9
<b>Key Material</b>	SAE 6150 with Satin finish	

Individual packing: Blister card



## ▶ 902-101 16 PC Hex Key Wrench Set



- Material: SAE6150 chrome vanadium steel
- Portable packaging.
- Case can be hung for storage or display

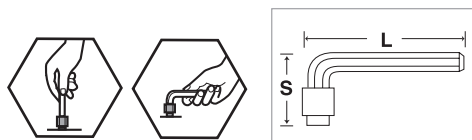

Tip size(mm)	S (mm/inch)	L (mm/inch)	Tip size(inch)	S (mm/inch)	L (mm/inch)
1.5	14/0.55	45/1.8	1/16"	14/0.55	46/1.8
2	16/0.62	51/2.0	5/64"	17/0.62	48/1.9
2.5	19/0.74	57/2.2	3/32"	17/0.62	52/2.0
3	20/0.78	65/2.6	1/8"	20/0.78	58/2.3
4	24/0.94	70/2.8	5/32"	22/0.86	65/2.6
5	29/1.14	80/3.1	3/16"	25/0.98	72/2.8
5.5	29/1.14	88/3.5	7/32"	28/1.10	77/3.0
6	33/1.3	94/3.7	1/4"	29/1.14	86/3.4

Individual packing: Blister card



## ▶ 900-038 30 PC Metric & Inch Combination Hex Key Set



- Material: SAE6150 chrome vanadium steel
- Portable packaging.
- Case can be hung for storage or display

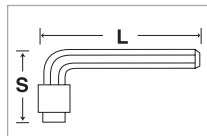
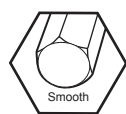

Hanger

Tip size(mm)	S (mm/inch)	L (mm/inch)	Tip size(inch)	S (mm/inch)	L (mm/inch)
0.7	8/0.31	35/1.4	0.028"	8/0.31	65/2.6
0.9	10/0.39	38/1.5	0.035"	10/0.39	68/2.68
1.3	12/0.47	41/1.6	0.050"	12/0.47	72/2.83
1.5	14/0.55	45/1.8	1/16"	14/0.55	77/3.0
2	17/0.66	50/2.0	5/64"	15/0.59	82/3.23
2.5	19/0.74	56/2.2	3/32"	18/0.70	89/3.5
3	20/0.78	65/2.6	7/64"	18/0.70	93/3.7
4	25/0.98	70/2.8	1/8"	19/0.74	98/3.86
4.5	27/1.06	77/3.0	9/64"	20/0.78	103/4.1
5	29/1.14	81/3.2	5/32"	22/0.87	107/4.21
5.5	31/1.2	86/3.4	3/16"	25/0.98	117/4.6
6	33/1.3	93/3.7	7/32"	28/1.10	127/5.0
7	36/1.4	100/3.9	1/4"	29/1.14	138/5.43
8	37/1.5	103/4.1	5/16"	35/1.4	155/6.1
10	44/1.7	117/4.6	3/8"	36/1.4	177/6.97

Individual packing: Blister card





# SOCKET WRENCHES

## ▶ HW-6509B/ HW-6514B 9 PC/ 14 PC Combination Wrench

**Cr-V**

- Made of Chrome Vanadium Steel with mirror finish provides corrosion resistance
- Compact size for easy access in confined spaces
- Slim line spanners reduce problems with hard to reach nuts
- Complete set for automotive, industry, home use and more
- Comes with tool pouch for easy carrying and storage



Tool Pouch

Model No.	Spec.(Metric)
HW-6509B	8.10.11.12.13.14.15.17.19mm
HW-6514B	8.9.10.11.12.13.14.15.16.17.18.19.22.24mm

Individual packing: Color box



## ▶ HW-312S / HW-312B / HW-5912E 12 in 1 Type Ratcheting Box End Reversible Wrench



- 12 sizes in one reversible ratcheting wrenches for superior versatility and ease of use
- 72-teeth gear design delivers 5 degree effective swing arc which makes work more efficient in limited areas
- Made of heat treated Cr-V steel with full polish for durability
- High torque capacity
- With forward, fixed and reversible function for easy operation



Long bolts and threaded rods are not a problem for the 12 in 1 wrench.

**12 in 1**

Model No.	Spec.	OAL(mm/inch)
HW-312S	● 8, 10, 11, 13mm	160/6.3
	● 5/16", 3/8", 7/16", 1/2"	
	● E10, E12, E14, E16	
HW-312B	● 14, 16, 17, 19mm	230/9.06
	● 9/16", 5/8", 11/16", 3/4"	
	● E18, E20, E22, E24	
HW-5912E	Contents: HW-312S, HW-312B	160/230 (6.3/9.06)

Individual packing: Blister card



72-teeth gear, only 5° space for each turn



HW-312S

HW-312B

## ▶ 900-070 / 900-217 10 PCS Electronic Combination Wrench



• Material: AISI 1045

Model No.	Spec.
900-070 (Inch Size)	Closed end 7/16", 11/32", 3/8", 9/32", 5/16", 1/4", 15/64", 7/32", 5/32", 3/16"
	Open end 3/8", 5/16", 11/32", 1/4", 9/32", 15/64", 7/32", 13/64", 3/16", 5/32"
900-217 (Metric Size)	Closed end 11, 10, 9, 8, 7, 6, 6, 5.5, 4.5, 4mm
	Open end 10, 9, 8, 7, 6, 5.5, 5, 4, 4.5mm

Individual packing: Pouch

## ▶ 900-067/900-068/900-069 Adjustable Wrenches



- Economy type
- Knurled adjustable screw
- Drop forged
- PVC coated handles

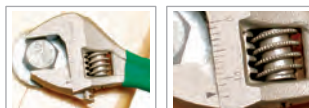

900-067

900-068

900-069

Model No.	Material	Jaw open (Max)	OAL.
900-067	S50C	1/2"(13mm)	4"(100mm)
900-068	S50C	13/16"(19mm)	6"(150mm)
900-069	S50C	1"(25mm)	8"(200mm)

Individual packing: Blister card

## SK-42601M 26 PC 1/2" Drive Socket Tool Set

**Pb** Tools meet DIN standard



72Teeth Reversing Flat Ratchet Handle



Spark Plug Socket



Sliding T Handle with Quick Release

14pcs Hand Socket 10,12,13,14,15,16,17,18,19,22,24,27,30,32mm
4pcs Hand Deep Socket 12,14,17,19mm
2pcs Spark Plug Socket W/Magnetic 16,21mm
Extension Bar W/Quick Release 125mm
Extension Bar W/Quick Release 250mm
Sliding T Handle W/Quick Release 250mm
LED Light Adaptor
Universal Joint
72 Teeth Reversing Flat Ratchet Handle W/Quick Release
Metal Case: 445x185x50mm (18"x7.3"x2")
Individual Packing : Color Sleeve Shrink

## SK-22401M 24 PC 1/4" Drive Socket Tool Set

**Pb** Tools meet DIN standard



Universal Joint



Spinner T Handle



Extension Bar W/2 way

13pcs Hand Socket 4,4.5,5,5.5,6,7,8,9,10,11,12,13,14mm
5pcs Hand Deep Socket 8,10,11,12,13mm
Extension Bar W/Wobble 2 Way 100mm
Extension Bar 55mm
Sliding T Handle 115mm
Universal Joint
Spinner Handle
72 Teeth Reverse Flat Ratchet Handle W/Quick Release
Metal Case: 245x120x35mm (9.6"x4.7"x1.4")
Individual Packing : Color Sleeve Shrink

## 900-194 23 PC 1/4" Drive Socket Set



Contents	
18 pcs 1/4" DR 4, 5, 6, 7, 8, 9, 10, 11, 12mm 3/16", 7/32", 1/4", 9/32", 5/16", 11/32", 3/8", 7/16", 1/2"	
140mm (5.5") ratchet handle	
Adaptor: 70mm(2.8"), 145mm(5.7")	
Steel box (214x84x44mm)/(8.4"x3.3"x1.7")	
Individual Packing : Color Sleeve Shrink	



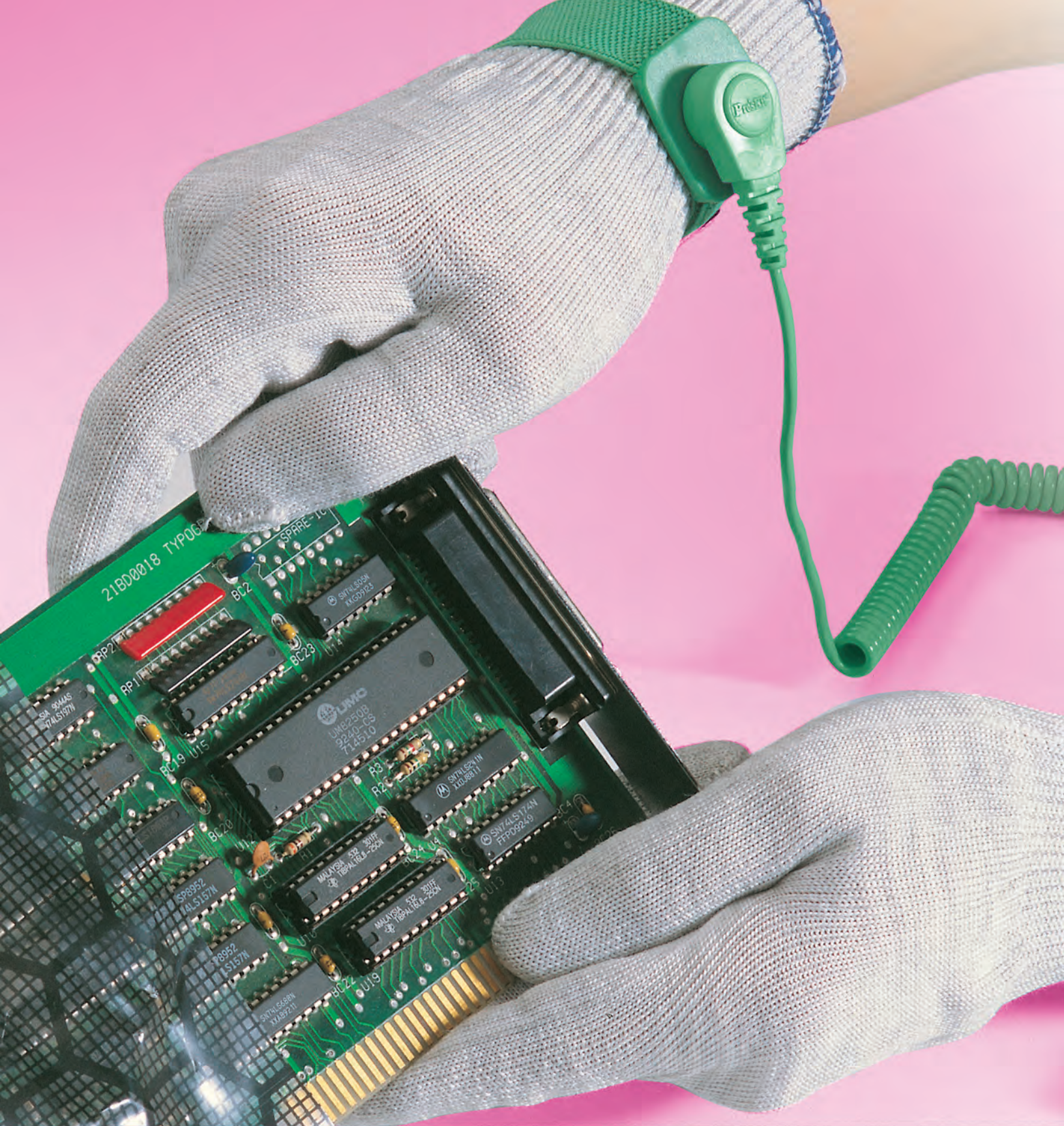

**ESD STATIC PROTECTION**

# Pro'sKit® ESD Tools Solution

## What is static electricity? How to prevent?

**Static electricity** is the imbalance of positive and negative electric charge caused by different materials rubbing together and building up a charge on the surfaces.

On production lines for electronic equipment, components such as IC's may be damaged by such static charges being discharged too quickly. For static control in work areas, use dissipative mats on floors and table surfaces and have personnel wear anti-static wrist straps and heel grounders.

**Pro'sKit®** ESD series of tools help to dissipate static charges and avoid potential costly problems.

## The resistance and decay time of conductor, static control products and insulator

**Conductor** means the materials which have the electrons held loosely and the electrons can move easily, most of metals are good conductors.

**Static control product** means the products designed for static control or elimination to protect electronic components and human body against injury.

**Insulator** means the materials which have the electrons held tightly and the electrons don't move well. Plastic, cloth, glass and dry air are good insulators.

	CONDUCTOR	STATIC CONTROL PRODUCT	INSULATOR
Resistance( $\Omega$ )	$10^5$	$10^8$	$10^{12}$
Decay time(SEC)	$10^{-6}$	$10^{-3}$	$10^0$

## ESD Products Test Method

**Pro'sKit®** ESD series products are tested in accordance with ESD Association standard as following EPA (ESD protected areas) ESD Control Program

ESD Control Item	Product Qualification <sup>1</sup>	
	Test Method	Required Limit(s) <sup>2</sup>
Worksurface	ANSI/ESD S 4.1 and or ANSI/ESD STM 4.2	$< 1 \times 10^9 \Omega$ and/or $< 200$ volts
Wrist Strap Cord	ANSI/ESD S1.1	$0.8 \times 10^6$ to $1.2 \times 10^6 \Omega$
Wrist Strap Cuff	ANSI/ESD S1.1	Interior $< 1 \times 10^5 \Omega$ Exterior $> 1 \times 10^7 \Omega$
Wrist Strap Cord Bending Life	ANSI/ESD S1.1	$> 16,000$ cycles
Foot Grounders	ESD SP9.2	$< 1 \times 10^9 \Omega$
Flooring	ANSI/ESD S7.1	$< 1 \times 10^9 \Omega$
Mobile Equipment (Working Surfaces)	ANSI/ESD S4.1	$< 1 \times 10^9 \Omega$

## Pro'sKit® ESD products applications

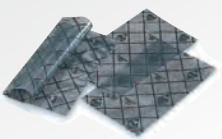

**Grid Bags**



**Tool Kit**



**Plier & Cutter**



**Stripper**



**Tweezer & Pick-Up Tool**



**Soldering & Desoldering**



**Screwdriver & Alignment Tool**

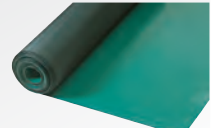

**Table & Floor Mat**



**Wrist Strap & Foot Ground**

### ▶ 900-002/900-012 Wrist Strap Series



Model No.	Band resistivity	Wrist strap resistivity	Band Size	Cord Size (feet)	Individual packing
900-002	<50Ω	10°Ω	Fixed	10 (3M)	Blister card
900-012				6 (1.5M)	

### ▶ 900-132/900-133 Wrist Strap Series



Model No.	Band resistivity	Cord resistivity	Band size type	Cord Size (feet)	Individual packing
900-132	<50Ω	10°Ω	Adjustable	10 (3M)	Blister card
900-133				6 (1.5M)	

### ▶ 900-022/900-023 Wrist Strap Series



Model No.	Band resistivity	Cord resistivity	Band size type	Cord Size (feet)	Individual packing
900-022	<10°Ω	10°Ω	Adjustable	10 (3M)	Blister card
900-023				6 (1.5M)	

### ▶ 900-057 Foot & Heel Ground



These versatile heel grounders have a specially designed dual-layered cup construction for superior floor contact.

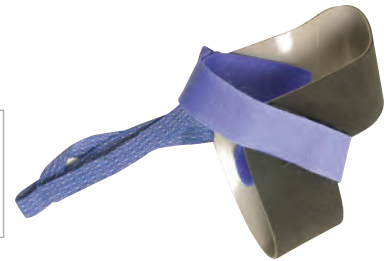

Polyester+conductive fiber

Resistivity	Wrist belt	Individual packing
1-2 x 10°Ω	Adjustable	Blister card

### ▶ 900-056 Field Service Kit



Material	Conductive PVC
Resistivity	10°~10 <sup>11</sup> Ω
Wrist belt	With 6ft wrist strap and 10ft grounding wire w/alligator clip
Size(mm/inch)	650x600/25.6x23.6
Individual packing	Color box



### ▶ 900-114/900-116 Static-Dissipative Mat



Model No.	900-114	900-116
Material	Face layer: 0.2mm laminated PVC Center, Layer: 2.7mm PVC foam, Bottom layer: 0.1mm laminated PVC, Combination layer: conductive treatment	
Resistivity	Face & Center & Bottom, Layers: 10M~1KMΩ/SQ Combination layer: 1K~1MΩ/SQ, Static decay time: less than 0.5sec	
Heat tolerance	70°C	
Description	Static dissipative mat for keyboard & mouse & touch	Static dissipative mat for OA desk-top
Size(mm/inch)	600x1200/23.6x47.2	600x600/23.6x23.6
Individual packing	Color box	Color box

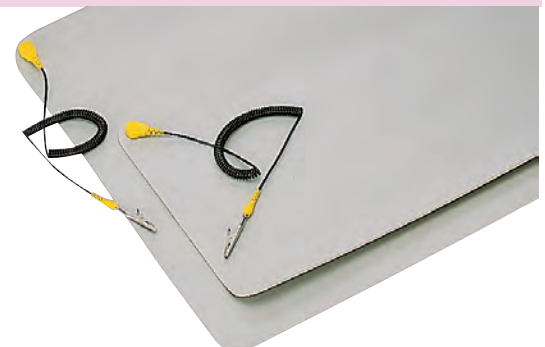



# PRECISION TWEEZERS

PRECISION TWEEZERS



## Ergo-Grip Tweezer

- Static dissipative handle  $10^8 \sim 10^{11}$
- Light weight design
- Precise tip offers safe access to hard-to-reach areas
- Cushioned handle increases operation comfort with less fatigue
- Constructed of high-quality stainless, chemical resistant; tough, non-magnetic surface.

### TZ-202N Super Fine Tip Straight Tweezer

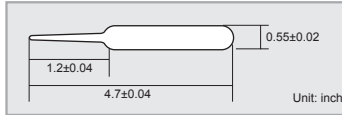

Material	Magnetic	OAL (mm/inch)	Individual packing
AISI 304	Non	120.5/4.7	Blister card

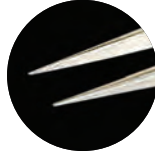

### TZ-204N Fine Tip Curved Tweezer

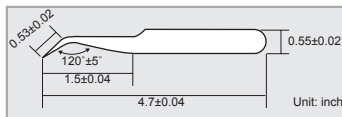

Material	Magnetic	OAL (mm/inch)	Individual packing
AISI 304	Non	120.5/4.7	Blister card



### TZ-205N Fine Tip Straight Tweezer

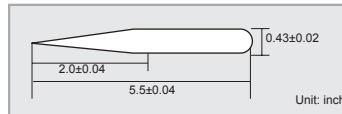

Material	Magnetic	OAL (mm/inch)	Individual packing
AISI 304	Non	140.5/5.5	Blister card

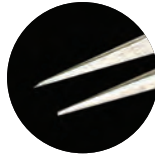

### TZ-212N Extremely Fine And Sharp Tip Tweezer

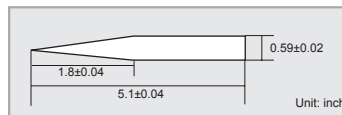

Material	Magnetic	OAL (mm/inch)	Individual packing
AISI 304	Non	129/5.1	Blister card



### TZ-225N Super Fine Tip Straight Tweezer

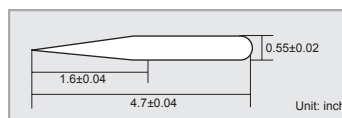

Material	Magnetic	OAL (mm/inch)	Individual packing
AISI 304	Non	120.5/4.7	Blister card



▶ **900-071 Super Fine Tip Straight Tweezer**

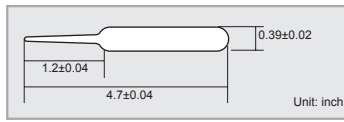
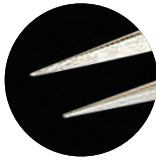

Material	Magnetic	OAL (mm/inch)	Individual packing
AISI 304	Non	120/4.7	Blister card

▶ **900-072 Fine Tip Curved Tweezer**

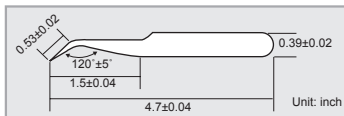

Material	Magnetic	OAL (mm/inch)	Individual packing
AISI 304	Non	120/4.7	Blister card

▶ **1PK-125T Super Fine Tip Straight**

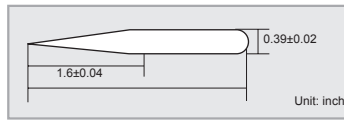

Material	Magnetic	OAL (mm/inch)	Individual packing
AISI 304	Non	120/4.7	Blister card

▶ **902-072 Heavy-Duty Tweezer**

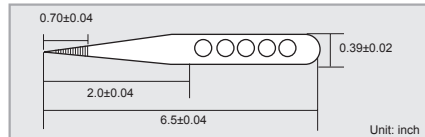
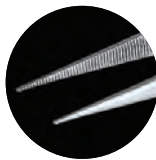

Material	Magnetic	OAL (mm/inch)	Individual packing
AISI 410	Yes	165/6.5	Blister card

▶ **900-204 4 PCS Tweezer Set**



OAL:115mm/4.5"



OAL:110mm/4.3"



OAL:119mm/4.7"



OAL:116mm/4.6"

Material	Magnetic	OAL (mm/inch)	Individual packing
AISI304	Non	110-120 4.3-6.3	Pouch

4 different style stainless steel tweezers for every need. Includes one self-locking; ideal for picking up small components in hard to reach places, as well as component assembly one pc prototype boards.

**▶ 902-071 Universal Tweezer**

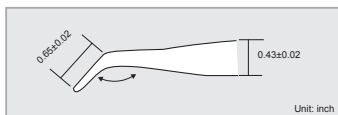

Material	Magnetic	OAL (mm/inch)	Individual packing
AISI 410	Yes	175/6.9	Blister card



**▶ 900-267 Reverse Action Tweezer (Self-Gripping)**

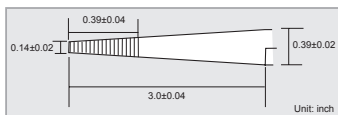

Material	Magnetic	OAL (mm/inch)	Individual packing
AISI 410	Yes	165/6.5	Blister card

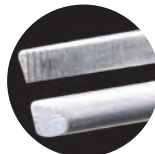

**▶ 900-268 Static Dissipative Soft Tip Tweezer**

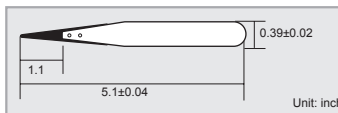

Material		Resistance	Replacement Tip	Magnetic	OAL (mm/inch)	Individual packing
Handle	Tip					
AISI 302	PPS-hb	<10 <sup>6</sup> Ω	5TZ-300A	Non	130/5.1	Blister card



**▶ 900-269 Static Dissipative Soft Tip Tweezer**

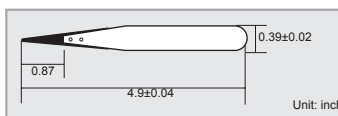

Material		Resistance	Replacement Tip	Magnetic	OAL (mm/inch)	Individual packing
Handle	Tip					
AISI 302	PPS-hb	<10 <sup>6</sup> Ω	5TZ-300B	Non	125/4.9	Blister card



**▶ 900-263/900-264/900-265/900-266 Conductive Tweezer**

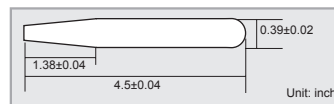
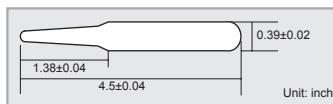
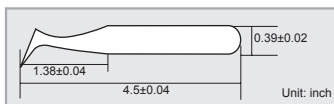
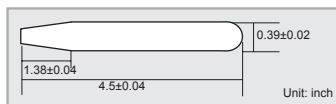

Model No.	Material	Resistance	Magnetic	OAL(mm/inch)	Individual packing
900-263	PC Carbon Fiber	<10 <sup>6</sup> Ω	Non	115/4.5	Blister card
900-264				120/4.7	

Model No.	Material	Resistance	Magnetic	OAL(mm/inch)	Individual packing
900-265	PC Carbon Fiber	<10 <sup>6</sup> Ω	Non	115/4.5	Blister card
900-266					



# MAGNIFICATION & LIGHTING



# Magnification/Lighting

The materials of Pro'sKit® magnifier & lamps include Glass and Acrylic.

## The characters of Glass:

- **Scratch-resistance:** The glass is not easy scratched due to their high density.
- **High-transmission:** It comes with smooth surface providing high transmission for clear view, anti-dust.
- **Low-glare:** The glass Lens feature low glare to reduce eye fatigue when used for long times.

## The characters of Acrylic:

- **Light-weight:** The weight of Acrylic is only half of glass.
- **Anti-impact:** The impact strength of Acrylic is 7-18 times higher than that of glass.
- **High-transmission:** It has the excellent transparent materials at present, and transmission is better than glass.



Glass Lens



Acrylic Lens

## The light source and electronic rectifier:

Pro'sKit® is always striving to improve its products to become more energy efficient and environment-friendly. All of Pro'sKit® magnifiers & lamps come with Electronic Rectifier features reducing the electromagnetic interference to almost zero and meet RoHS compliance. The Electronic Rectifier will provide even more stable performance and will light up more quickly for use than the traditional linear transformer.

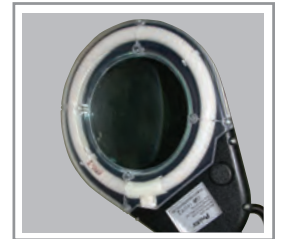

## Magnification Chart of Pro'sKit® Magnifiers & Lamps:

- **Diopter(D)** is a measurement unit of the refractive power of a lens. Each diopter means an object has been magnified by 25%.
- **Magnification(X)** is a measurement of how much larger an object is after magnification. A power of 2x means the object size has been magnified by 100%.
- **Focal Length** is the distance from a point where the image of a distance object is formed (focal point) to lens



Diopter	% Bigger Than Object	Magnification (X)	Focal Length (mm/inch)
1D	25%	1.25 X	1016 (40.00")
2D	50%	1.5 X	508 (20.00")
3 D	75 %	1.75 X	339 (13.33")
4 D	100 %	2.00 X	254 (10.00")
5 D	125 %	2.25 X	203 (8.00")
6 D	150 %	2.50 X	169 (6.67")
7D	175%	2.75X	145(5.71")
8 D	200 %	3.00 X	127 (5.00")
9 D	225 %	3.25 X	113 (4.44")
10 D	250 %	3.50 X	102 (4.00")
12 D	300 %	4.00 X	85 (3.33")
20 D	500 %	6.00 X	51 (2.00")
28 D	700 %	8.00 X	36 (1.43")
30 D	750 %	8.50 X	34 (1.33")



## Caring for Eye Care

When you are doing any of these things which require staring at one place for 30 minutes, it is important to take a break for 5 minutes and look at things farther away.

## ▶ MA-1209LA LED Table Clamp Magnifier Lamp



- The glass lens will provide high transmittance and will not easily scratch.
- 90 LEDs energy saving , low temperature and long life.
- Standard mount: Desktop clamp
- Power supplied with electronic rectifier provides even more stable performance
- Adjustable arm for easy positioning where it is most needed.
- Clamps easily and securely onto most flat surfaces up to 65mm/2.6" thick.



Lens material	Magnification	Lens size	Illumination	Voltage	Standard plug	Individual packing
Glass	5D (2.25X)	Ø 127mm / Ø5"	90 pcs LEDs	AC 110V~120V	A	Color Box

## ▶ MA-1503A Wide View Magnifier



- Power supplied with electronic rectifier provides even more stable performance
- Even, shadow-free light will make it easier for you to see and reduce eye strain.
- Spring balanced adjustable arm for easy maneuverability and positioning.
- Easy to replace the fluorescent tubes.

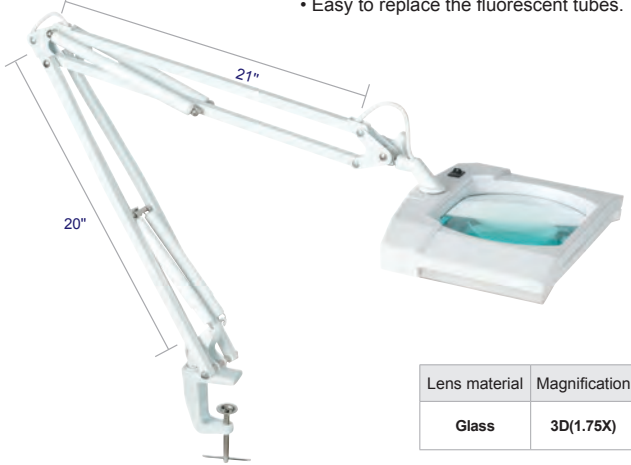

Lens material	Magnification	Lens size (mm/inch)	Illumination	Voltage	Standard plug	Individual packing
Glass	3D(1.75X)	Ø 190x155mm Ø7.5"x6.1"	PL 9W x 2 pcs	AC 110V~120V	A	Color Box

## ▶ 902-463 Floor Stand for Magnifier Lamp

- For use with magnifier lamps or bench work lights.
- Ease of moving with 5 swivel castors in any work area.
  - Weighted base for more stability



Material	Tube hole diameter	Dimension (W×H1×H2)	Weight
Spray painted steel tubing	Ø 13mm (0.5")	610×660×790 mm/ 24"×26"×31.1"	11 kg

Not all magnifying lamps can be fully extended using this base. Please be aware of tipping potential.

## ▶ 902-462 Weighted Base for Magnifier Lamp

For use with both magnifier lamps or desk lamps.

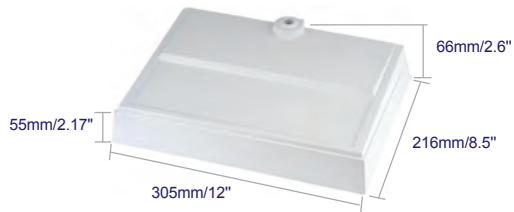

Material	Tube hole diameter	Dimension (L×W×H1×H2)	Weight
ABS with cast iron	Ø 13mm(0.5")	305×216×55×66 mm/12"×8.5"×2.17"×2.6"	10 kg

Not all magnifying lamps can be fully extended using this base. Please be aware of tipping potential.

## ▶ 900-061/MA-1205CA-B Magnifier Workbench Lamp



- Fully-adjustable spring arm with extra ABS sleeves outside of the springs for secure operation
- Power supplied with electronic rectifier provides reduced electromagnetic interference
- Wide open protection cover design can be swiveled up and won't spring back
- Even, shadow-free light will makes it easier for you to see and enjoy the activities longer.
- Spring balanced adjustable arm for easy maneuverability and positioning.
- Adjustable clamp base fits up to 65mm/2.6" thick surfaces.

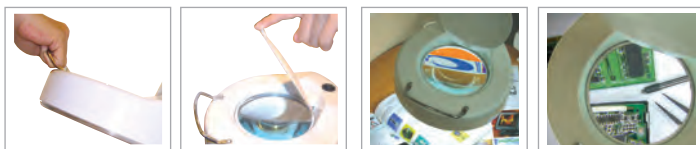

Model No.	Lens material	Magnification	Lens size	Illumination	Voltage	Standard plug	Color	Individual packing
900-061	Glass	5D(2.25X)	ø127mm (5")	22W	AC 120V	A	White	Color Box
MA-1205CA-B					AC 120V	A	Black	

Model No.	Description
900-061B	Light bulb
900-061-CLAMP	Clamp

## ▶ 902-109 Table Clamp Magnifier With Workbench Lamp



- 5 diopter (2.25X magnification) glass lens.
- Even, shadow-free light under the magnifying lens with 22-watt T5 circular fluorescent tube will make it easier for you to see .
- All metal housing mounted on a spring balanced arm that stays set in any position.
- Clamps easily and securely onto most flat surfaces up to 2.6" thick.
- Dust-proof cover for lens protection.



Lens material	Magnification	Lens size	Illumination	Voltage	Standard plug	Replacement bulb	Individual packing
Glass	5D(2.25X)	ø127mm (5")	22W/T5 G10q	AC 120V	A	Bulb-T5	Color Box

## ▶ 902-110 Gooseneck Magnifier Lamp



- Power supplied with electronic rectifier provides even more stable performance
- Even, shadow-free light will make it easier for you to see.
- The flexible gooseneck allows you to angle and point the light to where you need it most.
- Clamps easily and securely onto most flat surfaces up to 65mm/2.6" thick.



Lens material	Magnification	Lens size	Illumination	Voltage	Standard plug	Replacement bulb	Individual packing
Glass	5D(2.25X)	Ø 127mm (5")	22W/T5 G10q	AC 120V	A	Bulb-T5	Color Box



### ▶ OptiVisor Series "OptiVisor" Binocular Magnifier

- Reduces eye strain
- Optical glass (not plastic) lenses
- Genuine leather comfort band

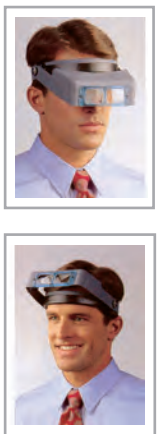

Complete OptiVisor	Magnification@Focal Length	Lense Plate Only
900-079	1.5X @ 20"	900-236
900-082	1.75X @ 14"	900-096
900-081	2X @ 10"	900-147A
900-075	2.5X @ 8"	900-075A
900-063	2.75X @ 6"	900-076
900-235	3.5X @ 4"	900-077

• Individual packing: Color box 900-142 OptiVisor with No Lens

### ▶ 900-064 "OptiLoupe" 2X Magnifier



- Bolts onto optivisor to double magnification
- Flips out of the way when not in use
- Individual packing: Blister card

### ▶ 900-125 Illuminated Magnifier

- Optical quality lighted magnifier with 2-1/2" round lens.

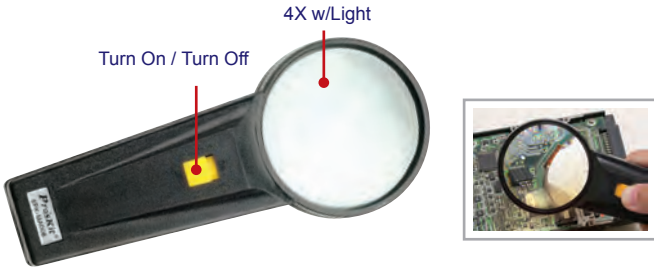

Lens material	Magnification	Lens size (mm/inch)	Light source	Battery	Replacement bulb	OAL	Individual packing
Glass	4X	Ø 62mm/ Ø2.4	Bulb	1.5V AA x 2 pcs (Not included)	900-125B	6-1/2"	Blister card

### ▶ MA-016 Headband Magnifier



- Detachable LED light device.
- The angle of LED light is adjustable.
- Multiple lens provide better magnification.
- The belt size can be adjusted freely.

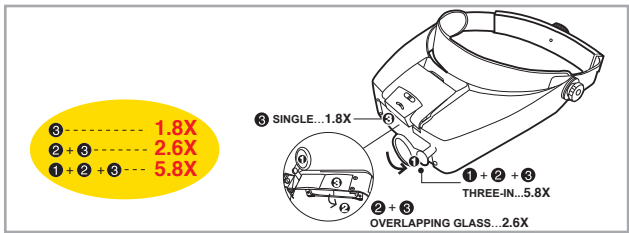

Materials	Acrylic	Light source	LED
Magnification	Single: 1.8X Overlapping: 2.6X Three-in: 5.8X	Battery	1.5V AAAx2 pcs (Not included)
Lens size	Round: Ø 29mm/Ø1.0" Square: 89x29mm/3.5"x1.1"	Individual packing	Color box

### ▶ 900-080/900-080B VisorLight

- Clips onto headband of Optivisor
- Xenon laser for illuminating close-up work



Model No.	Description	Individual packing
900-080	VisorLight (Headband shown but not included)	Blister card
900-080B	Replacement bulb for Visorlight	Blister card

### ▶ 900-126 Folding Lighted Magnifier

- Compact magnifier features a 2"x4" rectangular 2X lens, housed in the folding 4" handle.

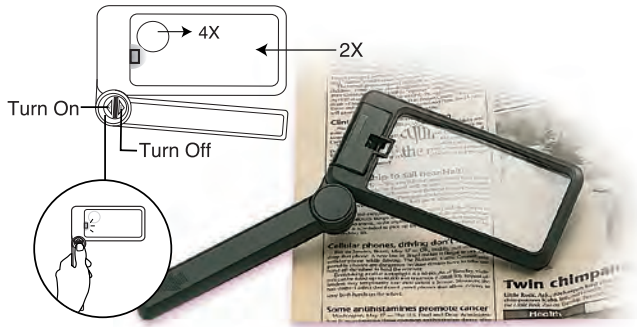

Lens material	Magnification	Lens size (mm/inch)	Light source	Battery	Individual packing
Acrylic	2X / 4X	96x49mm/3.8x1.9	Bulb	1.5V AAA x 2 pcs (Not included)	Blister card

### 900-123 Sliding Magnifier



3X (one lens)



### 900-124 Folding Magnifier



Lenses combined for higher magnification



### 902-239 8X LED Illuminated Magnifier



- Glass lens with hinged stainless cover.
- Great for very small objects, collection, and jewelry.



jewelry



Model No.	Lens material	Magnification	Lens size(mm/inch)	Light source	Battery	Individual packing
900-123	Acrylic	Single:8D (3X) Overlapping: 20D (6X)	22x35mm/ 0.87x1.4	-	-	Blister card
900-124		Single: 16D (5X) Overlapping: 36D (10X)	Ø 25mm/ Ø 1.0			
902-239	Glass	28D(8X)	Ø 21mm/ Ø0.82	LED	LRII30 (3AG12) x 3 (Included)	

### MA-020 22X Handheld LED Light Magnifier

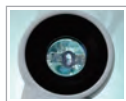

jewelry



- Comes with 2 LED lights
- Excellent for jewelry work

### MA-021 3.5X Handheld LED Light Magnifier



PCB checking



- Comes with 2 LED lights
- Suitable for reading, PCB checking and more.

### MA-022 7.5X Handheld LED Light Magnifier with Currency Detecting Function



Currency detection

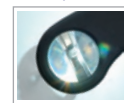

jewelry



- Comes with 1 LED light
- Combine with UV light for currency or credit card detection

Model No.	Lens material	Magnification	Lens size(mm/inch)	Light source	Battery	Individual packing
MA-020	Glass	Object lens 11.5D; Eyepiece 19D, (22X)	Ø 19mm/ Ø0.74"	2 LEDS	1.5V AAA x3pcs (not included)	Blister card
MA-021		10D (3.5X)	Ø 46mm/ Ø1.8"			
MA-022		26D (7.5X)	Ø 27mm/ Ø1.1"			

### 902-238 3X Magnifier



- Glass lens with plastic holding handle.
- Ideal for very small objects and documents reading.

Lens material	Magnification	Lens size(mm/inch)	Individual packing
Glass	8D (3X)	Ø 50mm / Ø2"	Blister card

### MA-019 3X Handheld LED Light Magnifier with Currency Detecting Function



8 LEDS



Reading



Currency detection



- Comes with 8 LEDs light
- With UV light for currency or credit card detection
- Ideal for reading, PCB checking, insect observation.etc

Lens material	Magnification	Lens size (mm/inch)	Light source	Battery	Individual packing
Glass	8D (3X)	Ø 56mm Ø 2.2"	8+1 LEDS (1 UV LED)	1.5V AAA x3pcs (not included)	Blister card

▶ **902-108 Desk Type Magnifier Lamp**



- The adjustable arm allows you to angle and point the light to where you need it most.
- The insert Lens allows partial magnification of object up to 12D for precision work.
- 12W fluorescent circular lamp
- Power supplied with electronic rectifier provides even more stable performance



Lens material	Magnification	Lens size	Illumination	Voltage	Standard plug	Replacement bulb
Glass	3D/12D (1.75X/4X)	Ø 100mm/ Ø3.9"	12W/T4 G10q	AC 110V~120V	A	Bulb-T4

Individual packing: Color box

▶ **902-221 Desk Type Magnifier Lamp**



- Easy swivel lens that rotates 360° and tilts 280°
- Powerful 2X(5D) magnifying lens
- 12W fluorescent lamp
- Adjustable joint arm for easy positioning
- Energy efficient and super bright
- Lifiable lens-protection cover

Lens material	Magnification	Lens size	Light source	Illumination	Voltage	Standard plug	Replacement bulb
Glass	2X (5D)	Ø 100mm/ Ø3.9"	T4 12W circular fluorescent lamp Supplied with Electronic ballast	12W/T4	AC 120V 60Hz	A	Bulb-T4

Individual packing: Color box

▶ **902-240 Foldable Magnifier**



- Glass lens with adjustable folding arms design.
- Sits on a desk or table and adjusts for varying height and angle.
- Great for working on hobbies, documents, and circuit boards, etc.

Lens material	Magnification	Lens size	Light source	Battery
Acrylic	2D (1.5X)	Ø 130mm/Ø5"	LED	LRI130 (3AG12) x3 (Included)

Individual packing: Color box

## FL-516 9 LED Flashlight

### Super bright, Mini size, 1m drop protection

- Sturdy anodized aluminum construction, sealed at both ends with high grade rubber o-rings, water repellent and 1M drop protection
- Super bright LEDs, palm size with wrist strap, ease of use ianywhere
- LEDs last up to 100,000 hours
- Ideal for home maintenance, outdoor activities, hiking, night fishing, camping and more



LED light

NEW

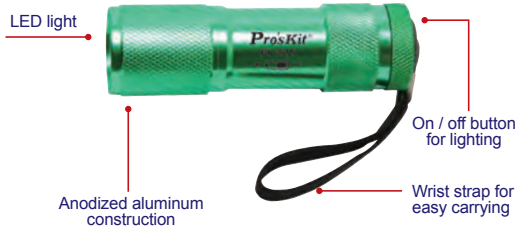

Light source	Material	Size	Battery
9pcs White LEDs	Aluminum	Ø27mm x 92mm	1.5V AAA x 3pcs (not included)

## 900-182 6 LED's Technology Flashlight



LED light



Battery	OAL (mm/inch)	Individual packing
2 x AA (not included)	152/6	Blister card

## 900-239 Magnifier Sheet

- Hold over any subject matter to magnify 3X(8D)~4X(13D)



- Individual packing: Poly bag

## FL-603 LED Flexible Flashlight

- Sturdy anodized aluminum construction, 13.6" hands free flexible arm attachment
- Flexible cable extension that can be bent and twisted into any shape or angle
- Two-way tail cap switch allows for twist on/off capability or push and hold functionality
- Ideal for auto repair, workshop or home DIY use and more



LED light



Auto repair



Electrical check

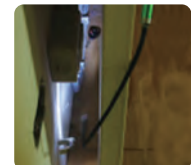

White light illuminates the tightest work areas

Light source	Illumination	Cable size	Handle size	Battery
White LED	11000mcd	Ø5mm x 13.6"	Ø15mm x 6.9"	1.5V AAA x 3pcs (not included)

- Individual packing: Blister card

## 902-068 LED Flashlight



LED light

- Rugged design aluminum body contoured for firm grip.
- Light weight and easy to carry.
- Operated using 2x AA cell batteries (not included).
- Switch on/off control on the bottom.
- Black color.

Twist head for spotlight effect      Material: Aluminum



Battery	Replacement bulb	OAL (mm/inch)	Individual packing
2 x AA (not included)	902-068B	152/6	Blister card

## 900-167 Protective Glasses

- Ideal for use when cutting, grinding or boring to protect the eyes against flying particles.



- Individual packing: Blister Card



**POWER TOOLS**



In this page, **Pro'sKit**® Power tools' adaptors comply with   and the certificate of drivers will be shown on each item.

## ▶ PT-1441A Cordless Drill Driver 14.4V

- No-load speed 0-550rpm
- 21 adjustable torque settings for screwing, and extra position for drilling purpose
- Maximum output torque up to 7nm
- 3/8" (10mm) keyless chuck for driver bits or drills
- Magnetic strip on the back for convenient operation
- Removable battery pack for charging convenience
- Variable speed trigger for complete control



	Model No.	PT-1441A
Main body	Max. Drilling capacity	Steel: Ø6mm Concrete: ø8mm Wood: Ø10mm
	Torque setting	21+1 positions
	Rated no load speed	One Gear Speed: 0-550rpm
	Output torque	7 Nm (71.4 kgf-cm/62.0 lbf-in)
	Drive (Collet)	3/8" (10mm) Keyless Chuck
	Special function	Switch for forward or reverse rotation, with drill function
	Overall length	225 x 245mm (8.9"x9.6")
Battery	Model No.	5PT-1441-BAT
	Battery type	Ni-Cd
	Battery voltage	14.4V
	Battery capacity	1000MAH
	Charging time	3-5 hours
	Free running time	40min
Adapter	Model No.	5PT-1441-ADA
	Input voltage	120V AC 60Hz
	Output voltage	DC 18V 400mA
	Adapter plug	A 
Charger	Model No.	5PT-1441-CH
	Voltage	DC 18V 400mAh
Standard Accessories	Model No.	5PT-1080-P1(13 pcs/set)
	Bits set	6pcs drill: Ø 1.5, 2.5, 3, 4, 5, 6mm 6pcs 25mm Driver Bits: ⊖ 5.0, 6.0 ⊕ #1, #2 ⊕ PZ#1, PZ#2 1 pcs Magnetic insert bits holder 1 pcs 50mm double ends driver bits ⊕ #2, ⊖ 6.0
	Others	Adapter and Charger / Blow-molded case (380x280x95mm) / 15"x11"x3.7"
Individual packing Color sleeve shrink		



Variable speed trigger for complete control



Removable battery pack for charging convenience



21+1 Adjustable torque settings

## ▶ PT-1201A Cordless Drill Driver 12V

- No-load speed 0-550rpm
- 16 adjustable torque settings for screwing, and extra position for drilling purpose
- Maximum output torque up to 6nm
- 3/8" (10mm) keyless chuck for driver bits or drills
- Removable battery pack for charging convenience
- Variable speed trigger for complete control



	Model No.	PT-1201A
Main body	Max. Drilling capacity	Steel: Ø6mm Concrete: ø8mm Wood: Ø10mm
	Torque setting	16+1 positions
	Rated no load speed	One Gear Speed: 0-550rpm
	Output torque	6Nm (61.2 kgf-cm / 53.11 lbf-in)
	Drive (Collet)	3/8" (10mm) Keyless Chuck
	Special function	Switch for forward or reverse rotation, with drill function
	Overall length	225mm x 245mm (8.9"x9.6")
Battery	Model No.	5PT-1201-BAT
	Battery type	Ni-Cd
	Battery voltage	12V
	Battery capacity	1000mAh
	Charging time	3-5 hours
	Free running time	35min
Adapter	Model No.	5PT-1201-ADA
	Input voltage	120V AC 60Hz
	Output voltage	DC 15V 400mA
	Adapter plug	A 
Charger	Model No.	5PT-1201-CH
	Voltage	DC 15V 400mA
Standard Accessories	Model No.	5PT-1080-P1
	Bits set	6pcs drill: Ø 1.5, 2.5, 3, 4, 5, 6mm 6pcs 25mm Driver Bits: ⊖ 5.0, 6.0 ⊕ #1, #2 ⊕ PZ#1, PZ#2 1 pcs Magnetic insert bits holder 1 pcs 45mm double ends driver bits ⊕ #2, ⊖ 6.0 1 pcs 45mm double ends driver bits ⊕ #1, ⊖ 5.0
	Others	Adapter and Charger / Blow carrying case
Individual packing Color sleeve shrink		



Variable speed trigger for complete control



Removable battery pack for charging convenience



16+1 adjustable torque settings

TWEEZERS

MAGNIFICATION & LIGHTING

FIBER OPTICS

POWER TOOLS

MISCELLANEOUS

INSTRUMENT CASES

LAN/DATACOMM

CONNECTORS

WIRING INSTALLATION

TOOL CASES

TOOL KITS

Index

## ▶ PT-1080A Li-ion Cordless Drill Driver 10.8V



- No-Load speed 0-350/0-1100 rpm
- 21 Adjustable torque settings for screwing, and extra position for drilling purpose
- Maximum output torque up to 14Nm
- 3/8" (10mm) Keyless Chuck for driver bits or drills
- Removable battery pack for charging convenience
- Variable speed trigger for complete control

Model No.	PT-1080A	
Main body	Max. Drilling capacity	Steel: Ø6mm Wood: Ø16mm
	Torque setting	21+1 positions
	Rated no load speed	two gear speed : 0-350/0-1100 rpm
	Output torque	14 Nm (142.8 kgf-cm/123.9 lbf-in)
	Drive (Collet)	3/8" (0.8-10mm) Keyless chuck
	Special function	Switch for forward or reverse rotation, with drill function 2 gear-speed switch LED battery power indicator
	Overall length	215 mm×210 mm/8.5"×8.3"
Battery	Model No.	5PT-1080-BAT
	Battery type	Li-ion
	Battery voltage	10.8V
	Battery capacity	1300MAH
	Charging time	3-5 hours
Adapter	Model No.	5PT-1080-ADA
	Input voltage	120V AC 60Hz
	Output voltage	DC 12V 500mA
Charger	Model No.	5PT-1080-CH
	Voltage	DC 12V 500mA
Standard Accessories	Model No.	5PT-1080-P1(13 pcs/set)
	Bits set	6 pcs Drills: Ø 1.5/2.5/3/4/5/6mm 6 pcs 25mm Driver bits: ⊖ 5.0 · 6.0 ⊕ #1 · #2 ⊕ PZ#1,#2 1pcs Magnetic insert bits holder
	Others	Adapter and Charger / Blow carrying case
Individual packing	Color sleeve shrink	



LED light provides convenient work in dark

Battery power indication

21+1 adjustable torque setting

## ▶ PT-0721A Li-ion Cordless Screwdriver-7.2V



4pcs 50mm Driver Bits

- Two gear speed : 0-200rpm/0-400rpm
- 1300mAh Li-ion battery. Long life battery pack, anti-pollution.
- 15+1 Adjustable torque settings.
- Maximum output torque up to 5nm
- Quick release chuck
- Switch for forward or reverse rotation.
- Battery power indication
- LED light provides convenient work in dark
- Handy and easy to carry in a tool belt
- Over charging and discharging protection

Model No.	PT-0721A	
Main body	Torque setting	15+1 Position
	Rated no load speed	two gear speed:0-200rpm/0-400rpm
	Output torque	5Nm (51 kgf-cm / 44.26 lbf-in)
	Drive (collet)	1/4 quick release chuck
	Special function	Switch for forward or reverse rotation, quick release chuck, LED light, battery power indicator
	Overall length: angled	160mm x 180mm/6.3"×7.1"
Battery	Battery type	Li-ion
	Battery voltage	7.2V
	Battery capacity	1300mAh
	Charging time	3-5 hours
Adapter	Model No.	5PT-0721-ADA
	Input voltage	120V AC 60Hz
	Output voltage	DC 9V 300 mA
Standard accessories	Bits set	4pcs 50mm Driver Bits: ⊖ 5.0, 6.0 ⊕ #1, #2
	Other	Adapter ; Pouch bag
Individual packing	Double blister card	



LED light provides convenient work in dark

Battery power indication

15+1 adjustable torque settings

In this page, **Pro'sKit**® Power tools' adaptors comply with   and the certificate of drivers will be shown on each item.

## ▶ PT-1361A Li-ion Cordless Screwdriver 3.6V



- 1300mAh Li-ion Battery. Long life battery pack, anti-pollution.
- Dual angle adjustment allows straight and angle use
- 6+1 Adjustable torque settings, maximum output torque up to 3 Nm
- Quick release chuck, switch for forward or reverse rotation.
- Battery power indication
- LED light provides convenient work in dark
- Over charging and discharging protection

Model No.	PT-1361A	
Main body	Torque setting	6+1 positions
	Rated no load speed	200 rpm
	Output torque	3 Nm (30.6 kgf-cm/26.55 lbf-in)
	Drive (Collet)	Hex 1/4 (6.3mm) quick release chuck
	Special function	Switch for forward or reverse rotation, 2 different angle settings Includes LED Light. LED Battery Power Status Indicator
	Overall length: straight Overall length: angled	235mm (L)/9.3" 170(L)x145(H)mm /6.7"x5.7"
Battery	Battery type	Li-ion
	Battery voltage	3.6V
	Battery capacity	1300mAh
	Charging time	3-5 hours
	Free running time	60 min
Adapter	Model No.	5PT-1361-ADA
	Input voltage	120V AC 60Hz
	Output voltage	DC 6V 300mAh
	Adapter plug	A 
Standard Accessories	Model No.	5PT-1361-P1 (4 pcs/set)
	Bits set	4pcs 50mm driver bits: ⊖ 5.0, 6.0 ⊕ #1, #2,
	Model No.	5PT-1080-P1(13 pcs/set)
	Other	Adapter
Individual packing	Double blister	



4pcs 50mm Driver Bits



LED light provides convenient work in dark



Battery power indication



Dual Angle

## ▶ PT-1136A Cordless Lighted Screwdriver 3.6V



- No-Load Speed: 200rpm.
- Maximum output torque up to 2.5Nm
- Switch for forward or reverse rotation.
- Soft grip handle can be used in 3 different positions
- LED light provides convenient work in dark
- Great in tight and difficult to reach spaces

Model No.	PT-1136A	
Main body	Torque setting	None
	Rated no load speed	200 rpm
	Output torque	2.5 Nm(25.5 kgf-cm/ 22.13 lbf-in)
	Drive (collet)	6.35mm (1/4") Hex Bit Shank
	Special function	Switch forward or reverse rotation, LED light Handle can be used in 3 different position
	Overall length: straight Overall length: angled	270mm (10-13/16") 210x140mm (7-23/32")
Battery	Battery type	Ni-Mh
	Battery voltage	3.6V
	Battery capacity	1000mAh
	Charging time	5-7 hours
	Free running time	30-35 min. (unload speed)
Adapter	Input voltage	120V AC 60Hz
	Output voltage	DC 6V 300mA
	Adaptor plug	A 
Standard accessories	2 pcs magnetic insert bits holder 11 pcs 25mm driver bits: ⊖ 3.0, 4.0, 5.0, 6.0, 7.0 ⊕ #1, #2, #3 ⊕ T10, T15, T20 Adapter	
Individual packing	Double blister card	



TWEEZERS  
MAGNIFICATION & LIGHTING  
FIBER OPTICS  
POWER TOOLS  
MISCELLANEOUS  
INSTRUMENT CASES  
LAN/DATACOMM  
CONNECTORS  
WIRING INSTALLATION  
TOOL CASES  
TOOL KITS  
Index

## PT-5721A Mini Grinder Set



- 1000mAh Li-ion Battery. Long life battery pack, anti-pollution.
- Low vibration, high torque and lightweight ergonomically designed
- Adjustable speed settings
- Quick Release Chuck
- Battery Power Indication
- LED light provides convenient work in dark
- Ideal for lightweight grinding, drilling, cutting, polishing, sanding, milling, sharpening, engraving and many other uses



Standard accessories: 9PT-5721-P2



LED light provides convenient work in dark



Battery power indication



On/Off speed adjustable controller

Max. diameter	Ø3.2mm
Rated no load speed	5000rpm~18000rpm
Battery Type	7.2V, 1000mAh, rechargeable Li-ion battery
Charging Time	3-5 hours
Free running time	60 min
Charger / Adaptor	Model No: 5PT-5721-ADA Input voltage: 120V 60Hz Output voltage: DC 9V 300mA Adaptor plug: A (□)
Standard accessories	9PT-5721-P2 • 2pcs brass collet (Ø2.4x1, Ø3.2x1) • 3pcs high speed drills (3/32" Ø2.4x 2, 1/8" Ø3.2 x1) • 2pcs Engraving bits (Ø2.4x 2) • 2pcs diamond bits (Ø3.2 x 2) • 2pcs nylon brush (Ø2.4, Ø3.2) • 4pcs grinding stones (Ø2.4x 2, Ø3.2 x2) • 1pcs sanding band (Ø2.4 x1)
Individual packing	Double blister card

## PT-5201A Mini Grinder



- Low vibration, high torque and lightweight ergonomically designed.
- Natural and comfortable operation body shape.
- The quick-change chuck is ideal for drilling, polishing, engraving, routing, shaping, sanding and milling.

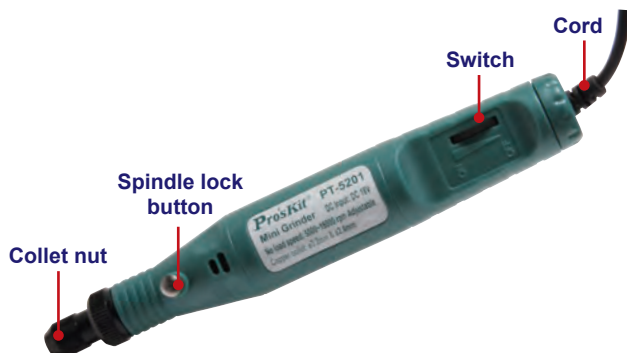

Replacement accessories: 9PT-5201-P2

Max. diameter	Ø3.2mm
Rated no load speed	5000~14000 rpm adjustable
Adaptor	9PT-5201A-P Output: DC 18V 400mA Input: AC 120V 60Hz Adaptor plug: A (□)
Replacement accessories	9PT-5201-P2 • 2 pcs diamond bits • 2 pcs grinding stones • 2 pcs sanding bands • 1 pc collet (Ø 2.4/ Ø 3.2 mm) • 1 pc nylon brush • 1 pc engraving bit • 1 pc connective post for sanding band
Individual packing	Double blister card



## PT-5501A Variable Speed Rotary Tool Kit



### Variable speed, 40pcs accessories, Outer Carbon brush , Flexible shaft

- Powerful variable speed from 10,000 to 32,000RPM
- Flexible shaft and cable attachment allows precision work
- 40-piece multipurpose accessories and carrying case included
- Outer carbon brush for replacement convenience
- Cutting, sanding, polishing, drilling, burr removal and more

**NEW**

Precision engraving



Comes with flexible shaft



Polishing



Model No.	PT-5501A
Maximum Output	135 W
No Load Speed	10,000-32,000 rpm
Collet Chuck Capacity	3.2mm and 2.5mm
Available Voltages	120V, 60Hz
Plug	A
Carrying Case Size	285x235x80mm / 11.22"x9.25"x3.14"
Individual packing	Color sleeve shrink





# FIBER OPTICS

# Fiber Optic Tools Technical Basics

**Pro'sKit®** is a leading supplier of fiber optic tools and accessories. The **Pro'sKit®** one-stop shop provides complete solutions for fiber optic termination tools such as strippers, Kevlar cutters, viewing scope, testers, fiber scribes, and cleaning kit.

## Fiber Optic Connectors:

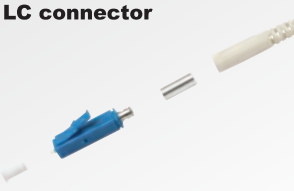
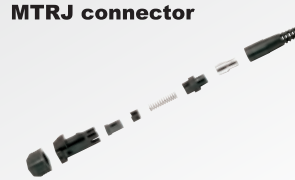
<p><b>ST connector</b></p>  <p>For datacom and telecom, widely used</p>	<p><b>SC connector</b></p>  <p>For multimode, rarely single mode, APC not possible</p>	<p><b>LC connector</b></p>  <p>For high-density connections, SFP transceivers</p>	<p><b>MTRJ connector</b></p>  <p>For duplex multimode connections</p>
--	---	---	--

• Please refer to our LAN category to find above products. You will also see many LAN Cat5e/6 accessories, including Patch Panel, Keystone Jack, Patch cord, Modular Plug, Flush Plate & Back Box, Inline coupler and Fiber Optic accessories. please explore it and find what you are looking for!

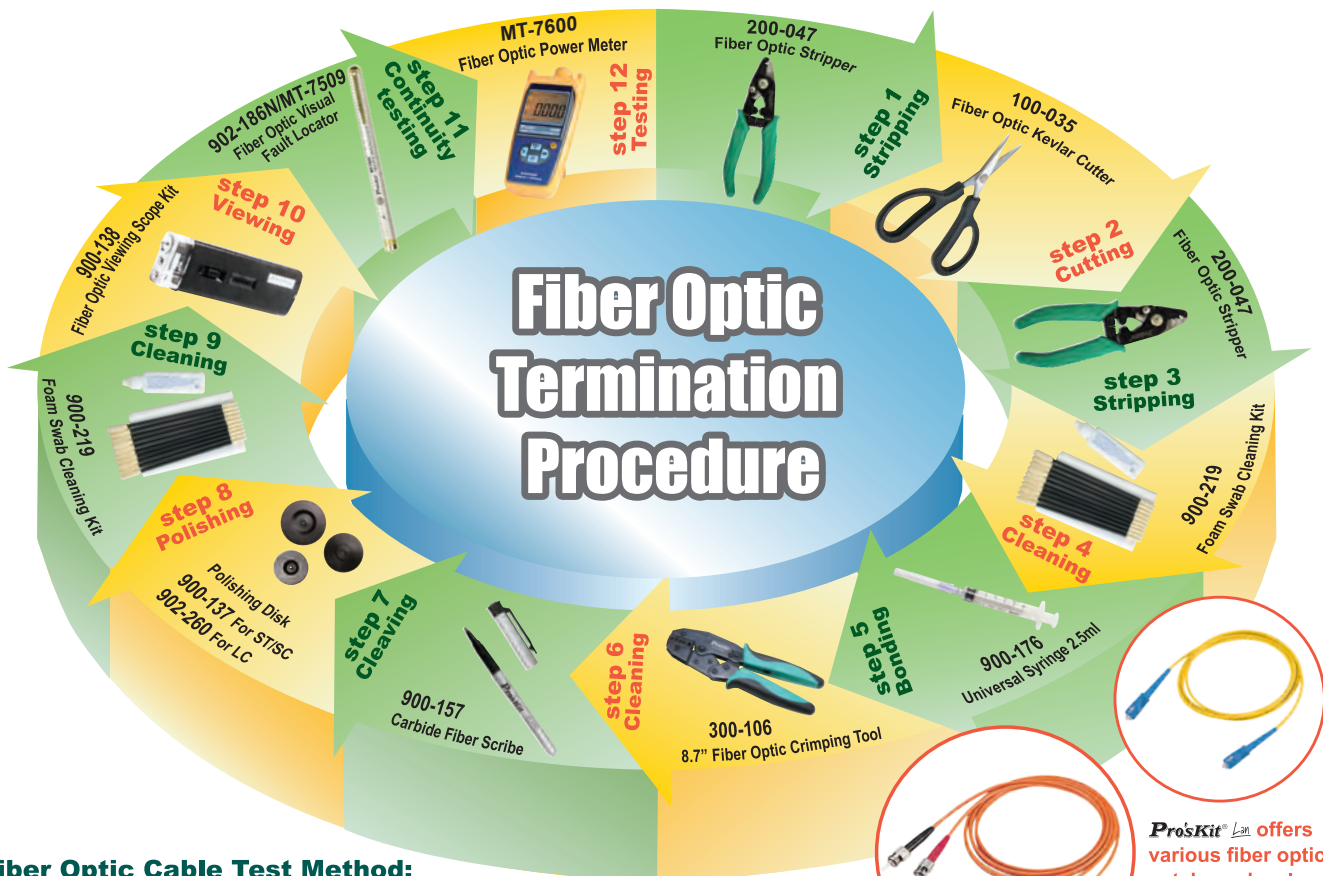

## Fiber Optic Cable Test Method:

After the cables are installed and terminated, it's time for testing. For every fiber optic cable assembly, you will need to test the continuity, end-to-end loss and troubleshoot the problems. **Pro'sKit®** fiber optic tester will help to do this step more efficiently.

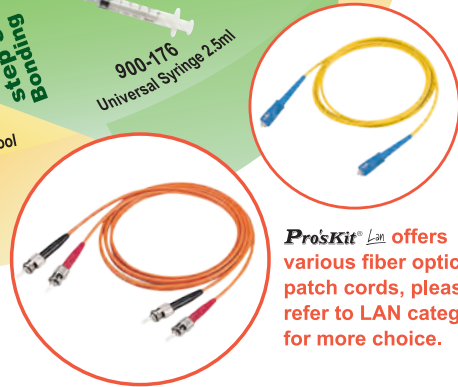

**Pro'sKit® Lan** offers various fiber optic patch cords, please refer to LAN category for more choice.

Continuity test by 902-186N/MT-7509



Continuity test

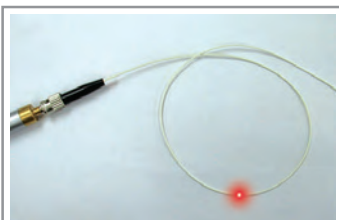

Break in fiber

End-to-end loss test by MT-7600

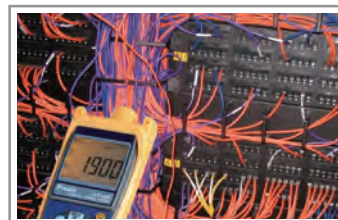

## ▶ MT-7600 Fiber Optic Power Meter



**Comes with ST/FC/multi connector for measuring wavelength 850/1300/1310/1550 nm**

Perfect for installation & maintenance of fiber optic networks in Datacom, Telecom, FTTH, CATV, CCTV, LAN and manufacturer of fiber optic equipment and cable.



- Features:**
- Use of InGaAs photodiode and flat response curve.
  - Function: dBm, dB, W.
  - Extra function, low battery indication, overload indication, auto power off, LCD backlight.



Fiber optic power test



Specification	
Measurement range	+3dBm ~ -55dBm, 2mW ~ 4nW
Accuracy	±0.3dBm
Display resolution	0.01
Photo diode	InGaAs
Measurement wavelength	850nm, 1300nm, 1310nm, 1550nm
Connector type	Multi (for ST, SC, FC, connectors)
Power source	Alkaline battery DC 1.5V x4 pcs (LR03/ AAA/ UM-4) (not included)
Size	185x84x42 mm / 7.3"x3.3"x1.7"
Weight	420 g
Accessories	Carrying case x 1 pcs (209x190x65mm) / 8.2"x7.5"x2.6" Patchcord: SCx1 pc LC adaptor (optional part# 5MT-7600-LC)
Individual packing	Sleeve with white box

## ▶ 3PK-NT018S-ST Mini Fiber Tester ST Type



3PK-NT018S

- Features:**
- Fastest display
  - Easiest operation
  - The most cost-effective solution
  - Automatically power-saving mode
  - Power on & battery low indicator

- Specifications:**
- Peak wavelength: 1300nm
  - Fiber core: 62.5/125µ
  - Power: 9 volt battery (Not included)



Accessories

DBm to micro Watt conversion	
-20dBm=10 micro Watt	-30dBm=1.00 micro Watt
-21dBm=7.9 micro Watt	-31dBm=0.79 micro Watt
-22dBm=6.3 micro Watt	-32dBm=0.63 micro Watt
-23dBm=5.0 micro Watt	-33dBm=0.50 micro Watt
-24dBm=4.0 micro Watt	-34dBm=0.40 micro Watt
-25dBm=3.2 micro Watt	-35dBm=0.32 micro Watt
-26dBm=2.5 micro Watt	-36dBm=0.25 micro Watt
-27dBm=2.0 micro Watt	-37dBm=0.20 micro Watt
-28dBm=1.6 micro Watt	-38dBm=0.16 micro Watt
-29dBm=1.3 micro Watt	-40dBm=0.10 micro Watt
Individual packing	
Blister card	



## ▶ 902-186N/MT-7509 Fiber Optic Visual Fault Locator



Measuring distance : 8KM



902-186N



MT-7509



Model No.	Connector type	Light source	Nominal wavelength	Battery	OAL(mm/inch)	Individual packing
902-186N	2.5mm/0.1" (FC/SC/ST)	Class 3A laser diode	650±10nm	1.5V AAA x2pcs (Not included)	Ø13.5x155mm/ Ø0.53"x6.1"	Color box with black EVA inner case
MT-7509	1.25mm/0.05" (LC)	Class 3A laser diode	650±10nm			

## ▶ FB-1688 Fiber Cleaver

- Features:**
- Simple and easy replacement of blade.
  - 16 cutting locations for each blade, service life up to 48000 times.
  - Replacement blade is available.
  - Whit debris collector bin.



Cladding diameter	Fiber count coating diameter	Cleave length	Dimensions	Cleaver Blade (5FB-1688-BLAD)
125 µm	Single fiber 250µm & 900µm	5-20 mm/ 0.2"-0.79"	62x60x56 mm/ 2.44"x2.36"x2.20"	16 cutting points Material: Tungsten steel

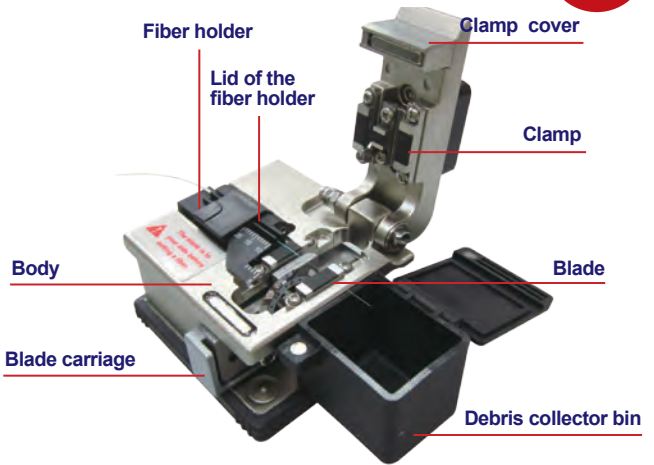

## ▶ 200-047 Fiber Optic Stripper



Strips 125 micron glass fiber with 250 micron buffer coating without scratching or nicking glass fiber.



Material	HRC	OAL(mm/inch)	Individual packing
S50C	48±2'	148/5.8"	Blister card

## ▶ CP-FB01 Fiber Optic Stripper

- Universal Stripper for 3.1x2.0mm FTTH drop cables with steel wire or FRP strength member.
- Made of zinc alloy with PVC non-slip handle.
- Improve cable splicing, more efficient and easy to use.



Materials	Applications	Dimensions
Body: Zinc alloy Blade: CR12, HRC:60-63	For stripping FTTH drop cable, fiber cladding diameter: 125 µm	30x110x20 mm/ 1.2"x4.3"x0.8"

▶ **900-138 Fiber Optic Viewing Scope Kit**



This fiber optic viewing scope kit makes it simple to view ST/SC Pre-encapsulated FDDI, and the ends of fiber before and after cleaving operations.



Made in USA



Magnification	Light source	Battery	OAL (mm/inch)	Individual packing
100X Adjustable	Bulb 2.25V/0.25A	1.5V AAx2pcs (not included)	148x46x25mm/ 5.8"x1.8"x0.98"	Blister card

▶ **100-035 Fiber Optic Kevlar Cutter**



For cutting Kevlar fiber optic cable



Micro serrated

Handle material	Blade HRC	Hardness (Cutting edge)	OAL (mm/inch)	Individual packing
TPR	60~62	HV1200	160/6.3"	Blister card

▶ **900-219 Foam Swabs Cleaning Kit**



For clean up of organic & inorganic residue in clean room and other areas. Ideal for fiber optic clean work

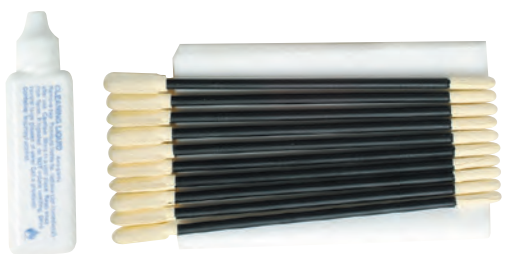

Individual packing
Blister card

▶ **900-157 Carbide Fiber Scribe**

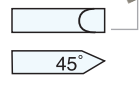

OAL (mm/inch)	Individual packing
Ø12x130mm Ø0.47"x5.12"	Blister card

▶ **900-176 Syringe Pack**



Individual packing
Poly bag+Header card (3pcs/pack)

▶ **900-137/902-260 SC/ST/LC Polishing Disk**



- Insert connector into polishing disk.
- Polish using a figure 8 motion on sandpaper sheet (not included)



900-137 (For SC/ST)



902-260 (For LC)



Model No.	OAL (mm/inch)	Individual packing
900-137	32.8/1.3"	Blister card
902-260	37.8/1.5"	

## ▶ PK-6940 / PK-6942 Fiber Optic Tool Kit

The tool kit contains a complete set of fiber optic termination tools such as strippers, crimpers, kevlar cutters, viewing scope and testers, also available are fiber scribes, and cleaning kit for easy and quick termination.

PK-6940	PK-6942
Fiber optic visual fault locator (For LC connector)	(None)
Fiber optic visual fault locator (For FC/SC/ST connector)	
Foam swabs cleaning kit	
Fiber optic viewing scope kit (SC/PC/FC)	
Fiber optic viewing scope disk (LC)	
Fiber optical stripper	
Carbide fiber scribe	
LC/SC/ST Fiber polishing disk	
Universal syringe 2.5ml	
8.7" fiber optic crimping tool	
Fiber optic kevlar cutter	
Utility component storage box	
Deluxe compact tool case (250x210x90mm/9.8"x8.3"x3.5")	
Individual packing	
Color Box	



PK-6940



PK-6942

## ▶ 500-023 Fiber Optic Tool Kit

Contents
Crimper - with additional die for more connector types (.100"/.213"/.218"/.190" and .042/.068/.151/.178/.213)
Nick-free strippers
Ergonomic wire cutters
Kevlar cutting scissors
TrueView fiber scope kt
SC/ST/FC polishing disks
Double-sided component box
Swabs
Alcohol bottle
Syringe
Tweezers
Chisel tip scribe
Zippered case
Individual packing
Inner box + Color label shrink



TWEEZERS

MAGNIFICATION & LIGHTING

FIBER OPTICS

POWER TOOLS

MISCELLANEOUS

INSTRUMENT CASES

LAN/DATACOMM

CONNECTORS

WIRING INSTALLATION

TOOL CASES

TOOL KITS

Index



# MISCELLANEOUS

## ▶ MS-525 9 IN 1 MULTI-TOOL

- Made of stainless steel, rugged and corrosion-resistant.
- Anodized aluminum handles with nonslip grip, more durable and comfortable.
- Comes with spring loaded long nose cutting pliers head.
- Folds to a compact pocket size that is convenient to take anywhere.
- With pouch bag for easy storage.
- Dimension: 6.3"(160mm) Overall (not including knives) and 3.9"(100mm) closed.



Contents
Serrated knife, Can opener, Phillips screwdriver, Knife, Saw, Bottle opener, Flat screwdriver, Flat file

## ▶ MS-526 12 IN 1 MULTI-TOOL

- Rugged stainless steel construction, corrosion-resistant.
- With nonslip rubber grip handle, more durable and comfortable.
- Comes with spring loaded long nose cutting pliers head.
- Folds to a compact pocket size that is convenient to take anywhere.
- With pouch bag for easy storage.
- Dimension: 6.1"(155mm) Overall (not including knives) and 3.9"(100mm) closed.



Application
Pliers, Scissor, Saw, Phillips screwdriver, Bottle opener, Can opener, Knife, Flat file, Flat screwdriver, Awl/Knife, Flat screwdriver

## ▶ CE-0275 Pin Extractors

- Designed for use with various connectors such as MOLEX, AMP, TYCO, etc
- 5 different size insertion tools
- Available individually or as a set of 5 in a pouch



Put the pin extractor into housing    Push the plunger of pin extractor    Extract the pin

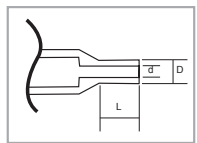

Model No.	L	DØ	dØ	(D-d)/2	Remark
902-394	0.45"	0.150"	0.122"	0.014"	-
902-395	0.57"	0.106"	0.085"	0.011"	Inter-locking
902-396	0.50"	0.157"	0.110"	0.023"	-
902-397	0.79"	0.126"	0.102"	0.012"	V.35 male
902-398	0.67"	0.130"	0.110"	0.008"	V.35 female

CE-0275 Contents: One each of five extractors above. Comes in plastic carrying pouch.

Individual packing	Blister card
--------------------	--------------



▶ **900-150/900-151 Measuring Tape**



- Blade with Nylon coating for easy scale reading and avoiding light reflection.
- Magnetic end-hook for convenient measuring.
- Anti-slip and shockproof rubber case.
- Hi-rel power tape.



**900-150**



**900-151**

Model No.	L (Max.)	W (Max.)	Individual packing
900-150	5M/16ft	23.0mm/0.91"	Blister card
900-151	7.5M/25ft	24.5mm/0.96"	Blister card

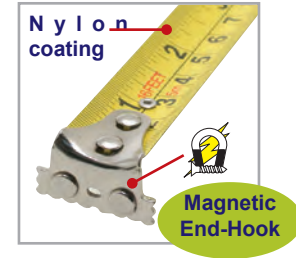

▶ **400-044 6" Digital Caliper**

- Hardened stainless steel.
- High quality 6" (150mm), thumb wheel for accuracy and ease with 4 measurement: inside, outside, depth and step.
- Precision-ground and lapped measuring surface.



Depth diameter measurement



Inside diameter measurement



Outside diameter measurement

Material	Range	Accuracy	Resolution	Individual packing
AISI430	0-150mm/0-6"	±0.02mm/0.001"(<100mm) ±0.03mm/0.001"(>100mm)	0.1mm/0.0005"	Plastic box + Color label sleeve

▶ **PD-155 9" Torpedo Level**

- Lightweight and compact
- With magnet for hands-free work
- Provides accurate readings, including horizontal, vertical and 45-degree angles.
- Easy-to-read with fluorescent green gauges



Material	3 vials	OAL	Individual packing
ABS plastic construction	45°, 90° & 180°	220mm/9"	Blister card

▶ **900-019 5 PCS Needle File Set**

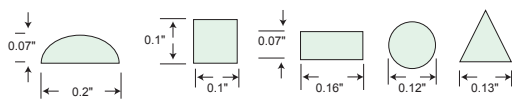

Material	HRC	Cut length	Handle O.D.	OAL	Individual packing
SKS-8	60°	75mm/ 3.0"	Ø 5mm/ Ø 0.2"	170mm/ 6.7"	Pouch

▶ **900-216 5 PCS Needle File Set**

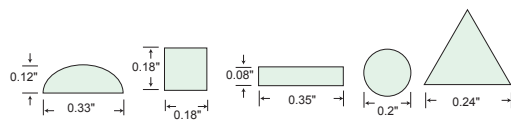

Material	HRC	Cut length	Handle O.D.	OAL	Individual packing
SKS-8	60°	85mm/ 3.3"	Ø 7mm/ Ø 0.28"	180mm/ 7.1"	Pouch

## ▶ 900-247 Round Hole Bread Board



- 840 tie points
- Round hole designed for easy plug and pull
- Expandable by combining several boards together to meet your different requirement
- Wearproof material made of ABS & phosphor bronze with good flexibility and electric conductivity



Excellent expandability

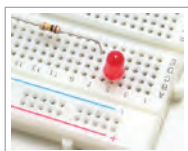

Friendly graduations

Individual packing
Blister card

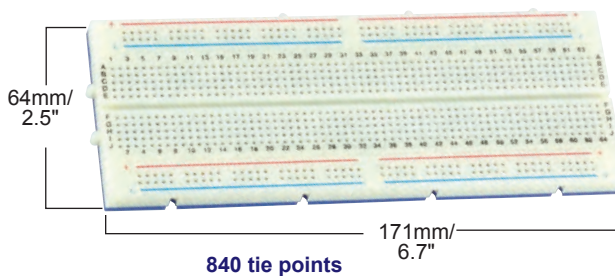

840 tie points

## ▶ 900-248/900-249 Round Hole Bread Board



### Application:

Used as a simulated layout for R&D and students.

### Features:

- Round hole designed for easy plug and pull
- Expandable by combining several boards together to meet your different requirement
- Wearproof material made of ABS & phosphor bronze with good flexibility and electric conductivity



Edge plate can easily fold up



Model No.	Tie points	Individual packing
900-248	1580	Blister card
900-249	2420	

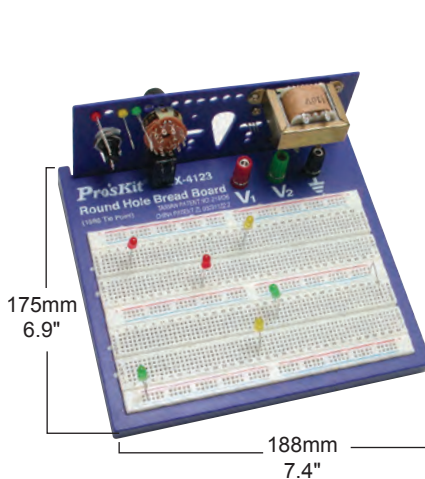

900-248 1580 tie points (Demo only)

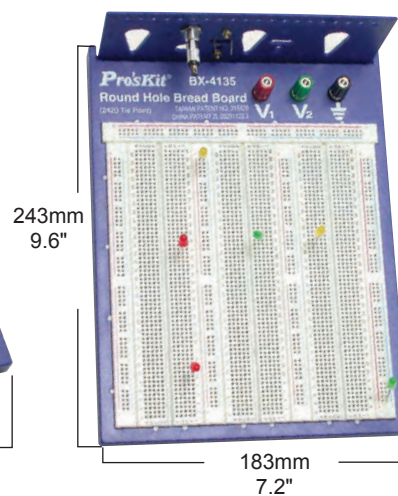

900-249 2420 tie points (Demo only)

TAIWAN PATENT NO. 215526  
CHINA PATENT ZL 03231122.2

## ▶ 900-271/900-272 Bread Board Accessory



- 70 pcs of 22 AWG solid wires
- Pre-cut, pre stripped and pre-formed on each end
- Variety of colors
- Completely reusable
- 14 lengths x 5 pcs each
- (2, 5, 7, 10, 12, 15, 17, 20, 22, 25, 50, 75, 100 and 125mm)

- 350pcs of 22 AWG solid wires
- Pre-cut, pre stripped and pre-formed on each end
- Variety of colors
- Completely reusable
- 14 lengths x 25 pcs each
- (2, 5, 7, 10, 12, 15, 17, 20, 22, 25, 50, 75, 100 and 125mm)



900-271

Case Size (mm/inch)	Individual packing
165x55x15/ 6.5x2.2x0.6	Poly bag + Hanger



900-272

Case Size (mm/inch)	Individual packing
178x90x28/ 7x3.5x1.1	Poly bag + Hanger

▶ **900-032 PLCC Extractor**

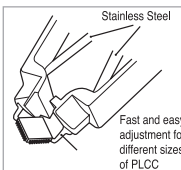

A spring assisted chip carrier extraction tool, specially designed for the safe removal of PLCC's from sockets without damage to component parts.

Material	OAL (mm/inch)	Individual packing
AISI 410 + POM	100x50/ 3.9"x2"	Blister card

▶ **902-224 PLCC Extractor**



Material	OAL (mm/inch)	Individual packing
AISI 210 + POM	145x76/ 5.7x3"	Blister card

▶ **900-094 3-Pronged Parts Grabber**

- Plunger opens prongs

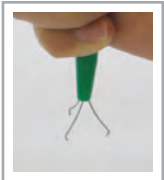

Individual packing  
Blister card

▶ **900-258 IC Extractor**

- Stainless steel construction for removing dual in-line IC packages. (Insulated vinyl grip.)

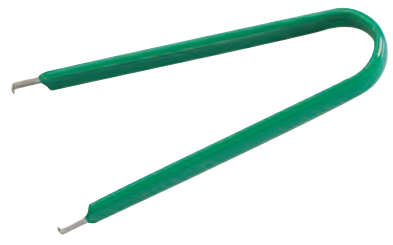

Individual packing  
Blister card

▶ **900-238 Vacuum Pick-Up Tool**

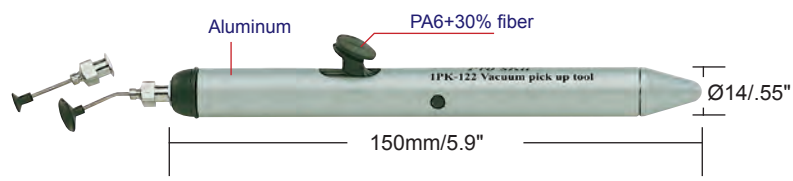

- The hand-held SMD vacuum pick-up tool is ideal for picking up and moving electronic components, large or small. With fountain pen dimensions, it fits easily into your hand or pocket.
- The new high-power probes have longer holding action.

**Function:**

- Lightweight, portable and suitable for picking and placing small components weighing up to 50 grams and having a flat surface, dilly packages and surface mount components, etc.

Individual packing  
Color box



### ▶ 900-103 Inspection Mirror



- All-angle ball joint mirror with stainless steel back.
- Visual inspection of hidden areas.
- Double ball joint links swivel mirrors for viewing to 360°.
- Made of tempered spring steel to move freely and hold desired position.
- Replaceable, plated, copper-backed, clear-view mirror.
- Non-rotating inner hex rods prevent mirror from swinging out of alignment.
- Insulating vinyl grip.



Lens size	OAL (mm/inch)	Individual packing
50x90mm (2"x3.5")	216 ~ 490 / 8.5"~19.3"	Blister card

### ▶ 900-255 Inspection Mirror



Lens size	Extension length	Individual packing
Ø32mm (1.25")	178~505mm (7.9"~19.9")	Blister card

### ▶ 900-212 Telescoping Magnetic Pick-up Tool



- Strong pick up force of 9 lbs.
- Allows access to "hard-to-reach" parts.
- Telescopes from 6-1/2" to 25-5/8"



Individual packing
Blister card

### ▶ MS-322 Telescopic Magnetic Pick-Up Tool



- A handy chrome plated telescopic magnetic retrieving tool.
- Ideal for hard-to-reach working.
- Extension length: max. 450mm(17.7")
- Maximum pick-up: 590g(1.3lb)



Individual packing
Blister card

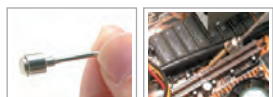

### ▶ 800-070 Magnetizer Demagnetizer



- A convenient pocket sized tool, housed in a strong plastic case.
- Ideal for the general magnetizer demagnetizer of small hand tool i.e screwdriver, hexagon keys.



Individual packing
Blister card



### ▶ 800-039 20 in 1 Screwdriver With Telescoping Pick-Up Tool



- Regular screwdriver with 13 pcs. screw bits  
5 pcs. sockets and 1 pcs socket adaptor fits all kinds of job.
- Telescoping magnetic pick-up tool (up to 17-1/2" long/440mm) stored inside the tube pulling out to pick up small metal objects.



Magnetic pick-up: 250g(Max.)

Individual packing
Blister card

**▶ 900-205 4 PCS Probe Set**



- 4pcs stainless steel single-ended probe that can be used for all kinds of precision work in electronics.
- Hook, curved, straight and angle tips 4 types packed in a vinyl pouch.

Material	OAL (mm/inch)	Individual packing
AISI 410	Straight:145/5.7 Angled:140/5.5	Pouch

**▶ 902-070/902-073 Spring Hook**



- Can grab small spring and wires.

Model No.	Material	OAL (mm/inch)	Individual packing
902-070	AISI 410	205/8	Blister card
902-073	+ PVC		

**▶ 1PK-3179 5 PC Spudger/Prying Tool Assortment**

This set contains 5 tools for opening and prying tablet computers, cell phones, monitors and disconnecting small electronic components without damaging housing or parts.



Contents
1 PC Double-ended metal spudger OAL:185mm
1 PC Nylon solder aid tools, OAL:150mm
2 PCS Polyoxymethylene (POM) opening levers, OAL:84.4mm, 88.7mm
1 PC Prying paddle, 30.5x30.5x30.5mm

**▶ 902-256/902-257 Push-button Pick-up Tool**

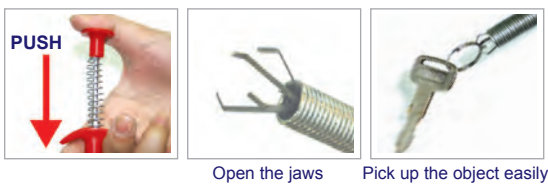
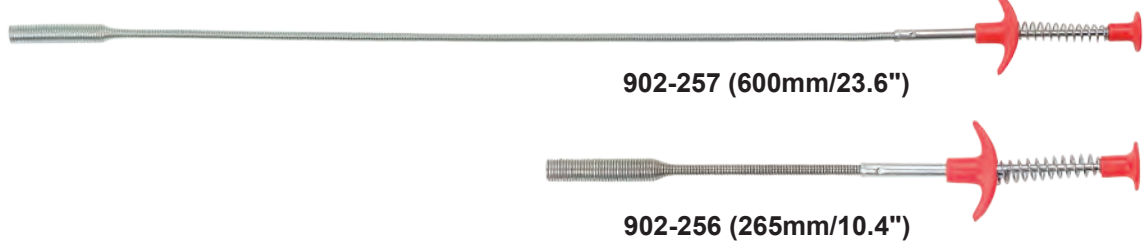

- 900-256: Push-Button Pick-Up Tool has a 265mm /10.4"flexible stem with a small set of jaws at one end.
- 900-257: Long Push-Button Pick-Up Tool has a 600mm /23.6"flexible stem with a small set of jaws at one end.
- Ideal for home, shop, garage, work place etc.

Individual packing	Blister card
--------------------	--------------

**▶ 902-255 Long Pick-up Tool with Magnet Tip**



Pick up small metallic objects from inaccessible areas

- Long Pick-Up Tool with Magnet Tip is an extendable magnetic tool for picking up small metallic objects from inaccessible areas.
- This Pick-Up Tool has a 620mm/24.4" flexible stem with a strong magnet at one end.
- Powerful magnet lifts 1.5KG
- Ideal for home, shop, garage, work place etc.

Individual packing	Blister card
--------------------	--------------

## 902-117 Multi-Angle Swivel-Actions Vacu-Vise



- Suction areas must be smooth, flat and clean.
- Adding a little water under vacuum base is recommended.

- Swivels 360° and tilts 90° to desired angle.
- 2.8" (70mm) metal jaws open to 2.7" (68mm).
- Equipped with slide-on rubber jaw for fragile work.
- 6 1/4" (158mm) triangular base.
- Aluminum die-cast construction.
- Light weight and durable.

Replacement Jaw	Individual packing
902-117-JAWS	Plain box+Color label

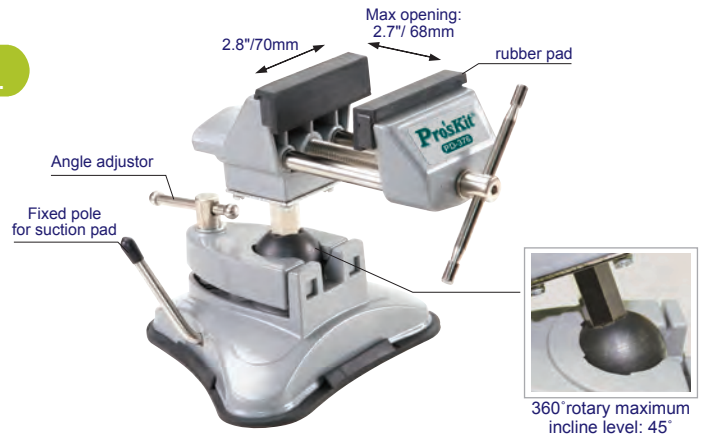

360° rotary maximum incline level: 45°

## 900-049 Hobby Vise



Individual packing  
Blister card

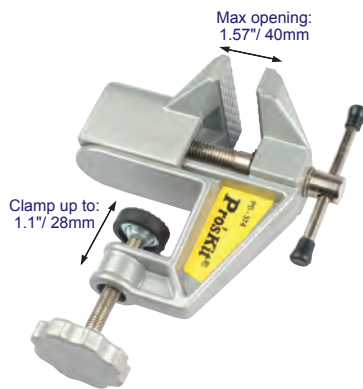

## PD-372 Mini Vise



Individual packing  
Blister card



## 902-116 6 In 1 Mini Hammer



- The 6 in 1 mini hammer with six different interchangeable heads: two round steel, one flat brass, one flat plastic and one tinner's steel.

OAL(mm/inch)	Individual packing
185/7.3	Blister card

## 900-179 Heavy Duty Curved-Claw



Material	Weight	OAL (mm/inch)	Individual packing
Handle: Fiberglass, S45C	454g (16 oz/1 lb)	330/13	Tag

## 900-058/900-181/900-222 Stainless Steel Forceps



Model No.	Material	Type	OAL (mm/inch)	Individual packing
900-058	AISI 410	Straight	130/5"	Blister card
900-181			160/6"	
900-222			155/6"	



900-058  
900-181



900-222

▶ **900-254 Blowing Brush**



- Clean blowing air effectively clears.
- Ideal for blowing hard-to-reach areas.



Material	OAL. (mm/inch)	Individual packing
Rubber + PC	ø62x130/ø2.4x5.1	Blister card

▶ **900-270 Mini Vacuum Cleaner**



Material	OAL (mm/inch)	Individual packing
polypropylene	128/5"	Blister card

▶ **900-251/900-252/900-253 Liquid Dispenser Bottles**



- Polyethylene bottles are not chemically reactive
- Purity pump to prevent backwash of contaminants into container



900-253                      900-252                      900-251



Model No.	Description	Individual packing
900-251	4 oz/114 ml	Poly bag + Hanger
900-252	6 oz/170 ml	Poly bag + Hanger
900-253	8 oz/227 ml	Poly bag + Hanger

▶ **900-230 Flux Bottle**



- Dispenses flux evenly with a fine tipped needle.



ø0.9x34mm

Material	OAL. (mm/inch)	Individual packing
PE	ø37x122/ø1.5x4.8	Poly bag + Hanger (2 pcs/pack)

▶ **900-158 Automatic Center Punch**

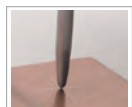

High speed steel (HSS)



Tip Material	OAL (mm/inch)	Individual packing
HSS	133/5.2	Blister card

▶ **900-177 Multi-Fuse Puller**

- Shock-proof durable plastic
- Serrated grip design to prevent slipping
- Safely removes 0~200A/250V and 0~100A/600V Cartridge fuses



Individual packing
Blister card



# INSTRUMENT CASES

▶ **TC-265 / TC266 / TC-267 Heavy Duty Waterproof Case**



water-tight seal for equipment protection



Comes with Pick and Pluck foam.

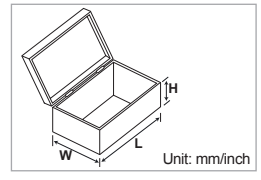

Model No.	Material	Loading Capacity	I.D.(LxWxH) (mm/inch)	O.D.(LxWxH) (mm/inch)	Individual Packing
TC-265	ABS	20 Kg/44Lb	430x290x163 17x11.4x6.4	455x340x175 18x13.3x7	Color label shrink
TC-266		15 Kg/33Lb	330x217x160 13x8.5x6.3	340x260x170 13.3x10.2x6.7	
TC-267		15 Kg/33Lb	300x180x153 11.8x7.1x6	328x232x170 13x9.1x6.7	

## ▶ SB-3218 / SB-4121 Multi-Function Tool Box With Removable Tote Tray



- Impact resistant
- Lift out tray
- Easy organization, easy to find

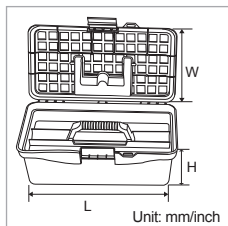
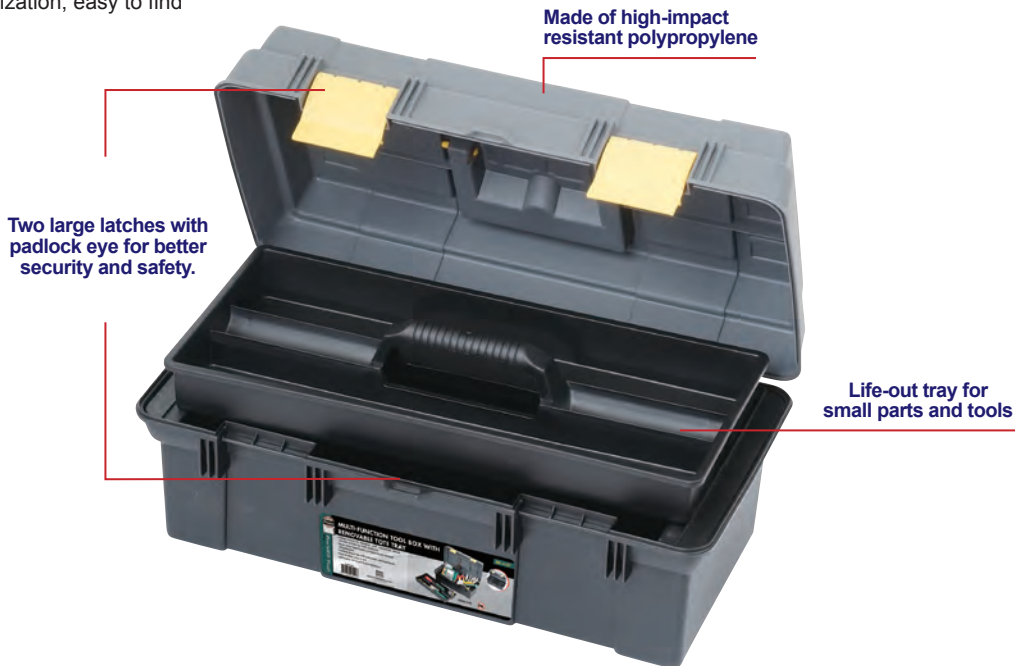

Model No.	Material	Loading Capacity	Dimension (LxWxH) (mm/inch)	Individual packing
SB-3218	polypropylene	5Kg/11Lb	315x175x130/ 12.4x6.9x5.1	Color label shrink
SB-4121		10Kg/22Lb	410x210x185/ 16.1x8.2x7.2	

## ▶ SB-2918 Multi-Function Tool Box With Storage Tray



- Made from high-impact resistant polypropylene.
- Heavy-duty tool box is ideal for home, office, auto or craft.
- Portable lift-out plastic storage box inside, great for keeping small items organized
- Comfortable and rugged handle for convenient carrying.

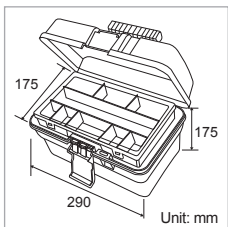

Material	Loading Capacity	Dimension (LxWxH) (mm/inch)	Individual packing
polypropylene	5Kg/11Lb	290x175x175/ 11.4x6.9x6.9	Color label shrink

**SB-3428SB / SB-4536B Service Case**



**SB-3428SB**

- Double sided opening
- Adjustable dividers up to 15 compartments and 5 large and 5 small removable inserts in the other side for storage flexibility



**SB-4536B**

- 6 large and 6 small removable inserts for storage flexibility

Model No.	Material	Dimension (LxWxH) (mm/inch)
SB-3428SB	polypropylene	340x280x80 13.6x11.0x3.1
SB-4536B	polypropylene + polystyrene	450x355x75 17.7x14.0x3.0
Individual packing		
Color label shrink		

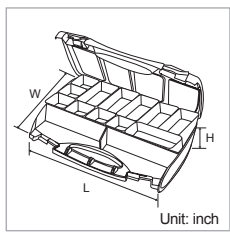

- Made from high impact resistant polypropylene and polystyrene, sturdy and durable
- Properly divided spaces reach the different needs of any small components
- Integrated handle and two locks for convenient carrying.
- Easy to store, easy to find

**SB-2419 Storage Box**



- Tight seal between top and compartments prevents small components from being mixed while closed.

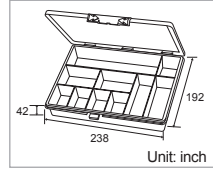
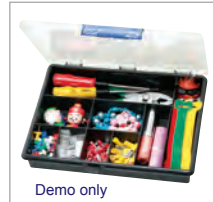

Material	Dimension (LxWxH) (mm/inch)	Individual packing
Polypropylene	238x192x42 9.4x7.6x1.7	Color label shrink

**9BX-3018B Blow Molded Case-Black**

This rugged molded case features storage for either Lunar or Crimpro frames and up to five of our standard dies (including one in the frame). This small, compact design is excellent for use in the field.

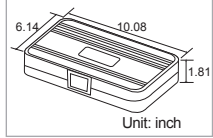

Material	Dimension (LxWxH) (mm/inch)	Individual packing
HDPE	256x156x46 10.08x6.14x1.81	Color label shrink



▶ **900-040 Utility Component Storage Box**



Demo only

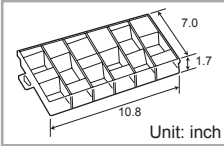

Unit: inch



Material	Dimension (mm/inch)	Individual packing
PP	275x177x42.5/10.8x7.0x1.7	Shrink packing

▶ **900-039 Utility Component Storage Box**



Demo only

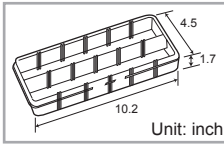

Unit: inch



Material	Dimension (mm/inch)	Individual packing
PP	260x115x43.5/10.2x4.5x1.7	Shrink packing

▶ **902-112 Utility Component Storage Box**



Demo only

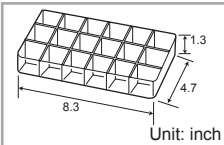

Unit: inch



Material	Dimension (mm/inch)	Individual packing
PP	210x119x32/8.3x4.7x1.3	Poly bag

▶ **902-113 Utility Component Storage Box**



Demo only

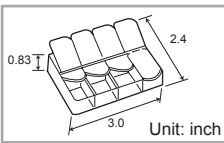

Unit: inch



Material	Dimension (mm/inch)	Individual packing
PP	76x61x21/3.0x2.4x0.83	Shrink packing

▶ **900-041 Utility Component Storage Box**



Demo only



Unit: inch



Material	Dimension (mm/inch)	Individual packing
PP	200x135x39/7.9x5.3x1.5	Shrink packing

▶ **900-043 Utility Component Storage Box**



Demo only

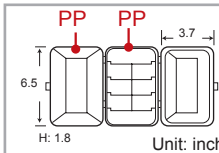

Unit: inch



Material	Dimension (mm/inch)	Individual packing
PP/PE	165x95x45/6.5x3.7x1.8	Shrink packing

▶ **902-114 Utility Component Storage Box**



Demo only

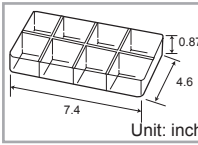

Unit: inch



Material	Dimension (mm/inch)	Individual packing
PP	187.5x117x22/7.4x4.6x0.87	Poly Bag

▶ **900-091A Parts Tubes**



Demo only

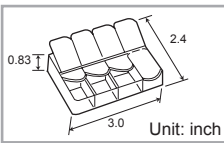

Unit: inch

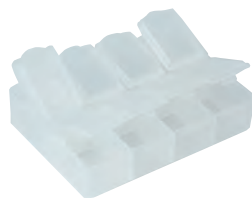

Material	Dimension (mm/inch)	Individual packing
PP	Ø20x130/Ø0.79x5.1	Clamshell (3pcs/pack)

## ▶ 900-164A/900-164B Instrument Cases



- The durable ABS plastic cases allow for various PCB mounting positions. Adhesive feet and screws are included, choose from 2 sizes. 900-164B has ventilation slots and speaker recess.

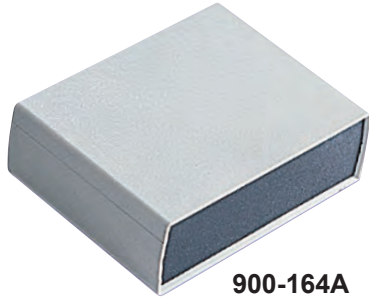

900-164A

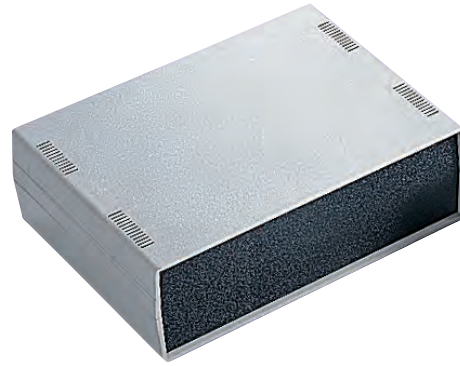

900-164B



Demo only

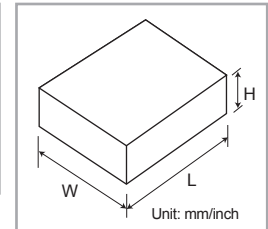

Model No.	Material	L(mm/inch)		W(mm/inch)		H(mm/inch)		Individual packing
		OD	ID	OD	ID	OD	ID	
900-164A	ABS	200/7.9	197/7.8	158/6.2	146/5.7	64/2.5	58/2.3	Poly bag
900-164B		253/10.0	250/9.8	190/7.2	176/6.9	82/3.2	76/3.0	

## ▶ 900-162A/900-162B/900-162C Die Cast Aluminum Enclosures



- The heavy-duty enclosures are made of high quality die-cast aluminum and have channeled walls for easy PCB mounting.
- These enclosures act as excellent heat sink.
- Easy assembly screws included.



900-162A



900-162B



900-162C

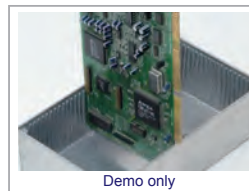

Demo only

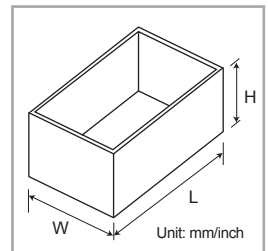

Model No.	Material	L(mm/inch)		W(mm/inch)		H(mm/inch)		Individual packing
		OD	ID	OD	ID	OD	ID	
900-162A	Aluminum	101/4.0	97/3.8	50.6/2.0	46.6/1.8	20.7/0.81	18.8/0.74	Shrink packing
900-162B		121/4.8	116.9/4.6	66.1/2.6	62/2.4	35.4/1.4	33.5/1.3	
900-162C		193.5/7.6	187.5/7.4	112.4/4.4	106.5/4.2	56.2/2.2	54/2.1	

**Width of inside grooves:  
2.95mm/0.16"**

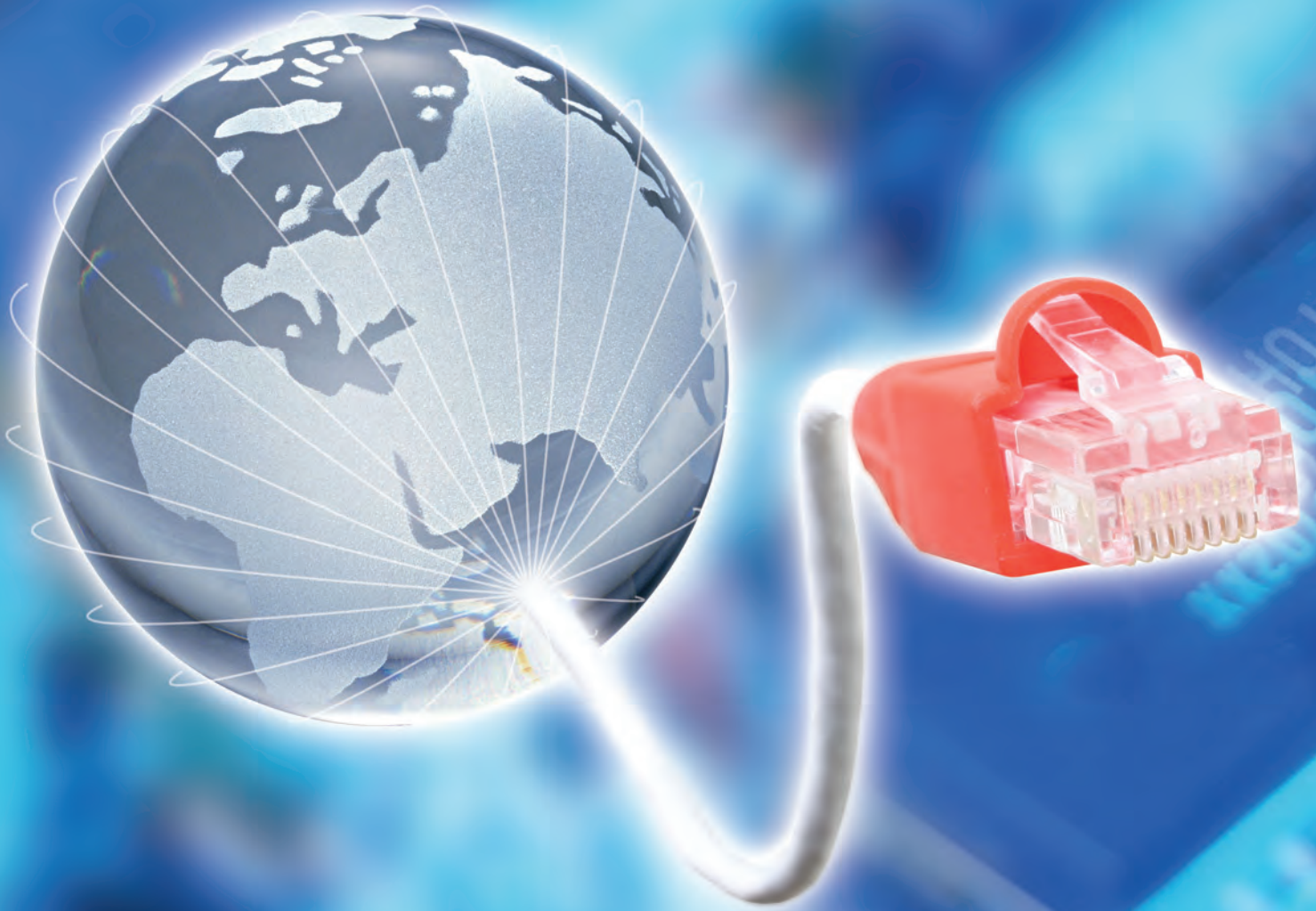

**LAN/DATACOMM**

**Cat.6/5e UTP Patch Panels with 45° Jack**



Our Cat.6/5e patch panels are used for high speed LAN's transmission. These panels were developed with a proprietary printed circuit board technology which results in performance to meet EIA/TIA 568A Category 5e Enhanced & Category 6 specifications. The new version of 110D terminal block can be used for both Krone & 110 tool, and has 568A and 568B color codes both on the top of new version 110D IDC for easy installation.

**Features**

- Can be used with 110 and Krone punch down tools
- Accept 22-26 AWG solid and stranded UTP cables.
- Meets T568A & T568B standards
- Standard 19" Rack Mount

**Specification**

- Panel: 1.5mm thick metal, black paint
- Jack: RJ45 8P8C, PBT UL94V-0 Ivory color, 50 micro inches gold plating over nickel plating
- Terminal Block: New version 110D connector, PC UL94V-0, white color
- Jack Bracket Set: ABS UL94V-0

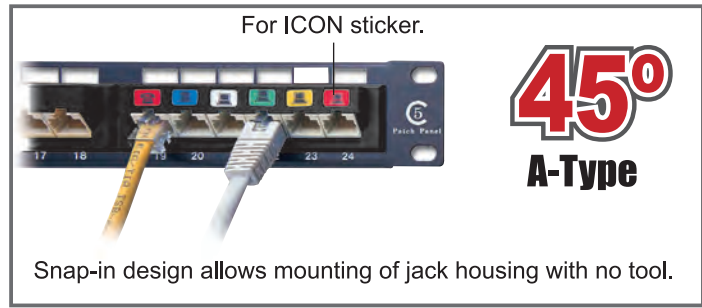

**New Version 110D Terminal Block**

Can be used for both krone & 110 style impact tool

**Remark:**  
Cable tie and cable holder are included for 45 degree angle and top entry type unshielded patch included panel.

Model No.	Description	Individual packing
7P-12AK11CEC-BK	12 Ports CAT.5e UTP Patch Panel	Color box
7P-24AK11CEC-BK	24 Ports CAT.5e UTP Patch Panel	Color box
7P-48AK11CEC-BK	48 Ports CAT.5e UTP Patch Panel	Color box

## Cat.6/5e UTP Patch Panel with Top Entry Type



**Old IDC Block**

When one core wire is installed into one old IDC pin, it is pierced with two parallel blades

**New IDC Block**

New IDC is similar to one pair of scissors. When one core wire is installed into one new IDC pin, the wire is pricked first with two sharp blades and then clipped.

**By simulating one pair of scissors, new IDC guarantees more precise puncture of wire core after clipping with two sharp blades.**

port indication UL Certified

**New 110D terminal block can be used for both "Krone & 110 style" impact tool**

**CABLE HOLDER**

New design of the cable holder can directly plug and lock onto P.C.B. It is more convenient for cable management. Each module comes with one cable holder.

**CABLE TIE**

Every module comes with a built-in jacket bracket with cable tie holders which use cable ties to hold the cable securely and to prevent pull-away.

Model No.	Description	Individual packing
7P-12TK11CEC-BK	12 Ports CAT.5e UTP Patch Panel	Color box
7P-12TK11C6C-BK	12 Ports CAT.6 UTP Patch Panel	Color box
7P-24TK11CEC-BK	24 Ports CAT.5e UTP Patch Panel	Color box
7P-24TK11C6C-BK	24 Ports CAT.6 UTP Patch Panel	Color box
7P-32TK11CEC-BK	32 Ports CAT.5e UTP Patch Panel	Color box
7P-48TK11CEC-BK	48 Ports CAT.5e UTP Patch Panel	Color box
7P-48TK11C6C-BK	48 Ports CAT.6 UTP Patch Panel	Color box

## Cat.6/5e Mini 12 Port Patch Panels

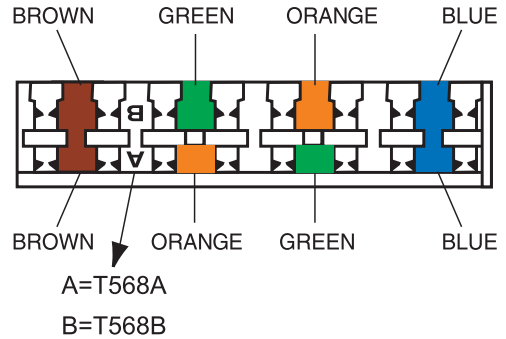
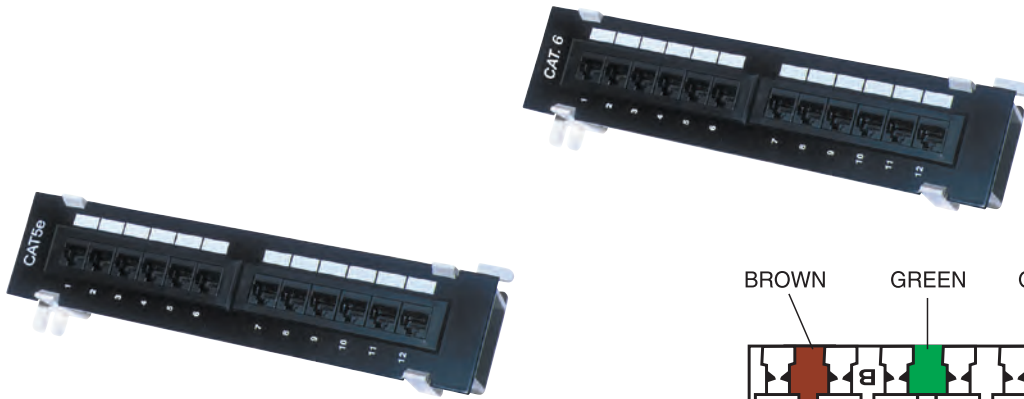

Our Cat.6/5e patch panels are used for high speed LAN's transmission. These panels were developed with a proprietary printed circuit board technology which results in performance to meet EIA/TIA 568A Category 5e Enhanced & Category 6 specifications. The new version of 110D terminal block can be used for both Krone & 110 tools, and has 568A and 568B color codes both on the top of new version 110D IDC for easy installation.

### Features

- Can be used with 110 and Krone punch down tools
- Meets T568A & T568B standards
- Supplied w/mtg bracket
- Great for home use

### Specification

- Panel: 1.5mm thick metal, black paint
- Jack: RJ45 8P8C, PBT UL94V-0 black color, 50 micro inches gold plating over nickel plating
- Terminal Block: New version 110D connector, PC UL94V-0, white color
- Jack Bracket Set: ABS UL94V-0

### Color Coding Information

IDC Terminals	T568A Pair/Wire Color	T568B Pair/Wire Color
PIN5 PIN4	1 White/Blue Blue	1 White/Blue Blue
PIN1 PIN2	3 White/Green Green	2 White/Orange Orange
PIN3 PIN6	2 White/Orange Orange	3 White/Green Green
PIN7 PIN8	4 White/Brown Brown	4 White/Brown Brown

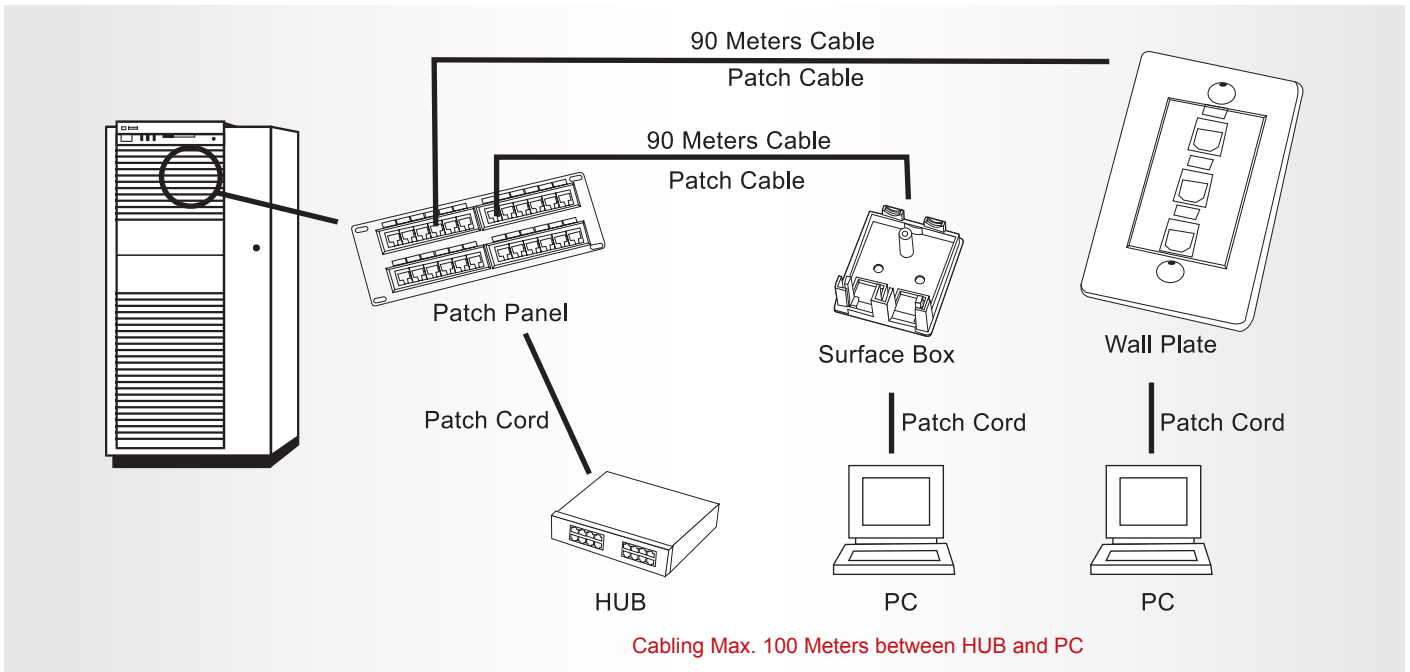

Model No.	Description	Individual packing
7PMV12T-K11-CEC/BK	CAT.5e Mini-Vertical 12 Ports Patch Panel	Inner box+Color label
7PMV12T-K11-C6C/BK	CAT.6 Mini-Vertical 12 Ports Patch Panel	Inner box+Color label

## ▶ 7KJ-P24-M 24 PORT KEYSTONE JACK PANEL-BLANK

24 Port blank keystone panel is versatile, allowing all snap-in Keystone Jacks, such as Cat5e, Cat6, RJ11 keystone jacks or, BNC, F, RCA, fiber type keystone inserts. Making it perfect for ethernet, voice or audio/video applications

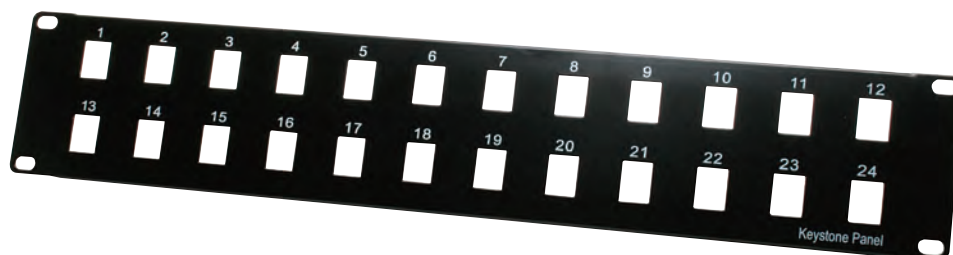

### Features

- Made from Cold Rolled Carbon Steel (SPCC)
- Clearly numbered 1-24 on the front for easy cable runs identification
- Mounts on any standard 19" Relay Rack, Cabinet, or wall Bracket.
- Blank patch panel for easy use in any combination of keystone jacks or inserts
- Dimensions: 3.5"(H) x 19"(W), keystone opening dimensions: 0.76"(H)x0.57"(W)



Demo only

## ▶ Tool-less Keystone Jack



### Application

Suitable for 23-24 AWG Wires



Unshielded Version

Our keystone jack has our advanced design IDC terminals with plastic lid. Tool-less design makes installation and maintenance of your T568A and B wiring system easy. The keystone jacks are available in EIA/TIA 568A Cat.5e & Cat.6 specification.

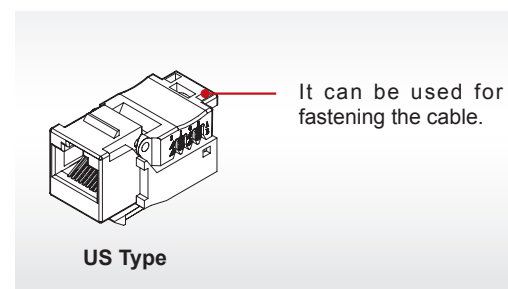
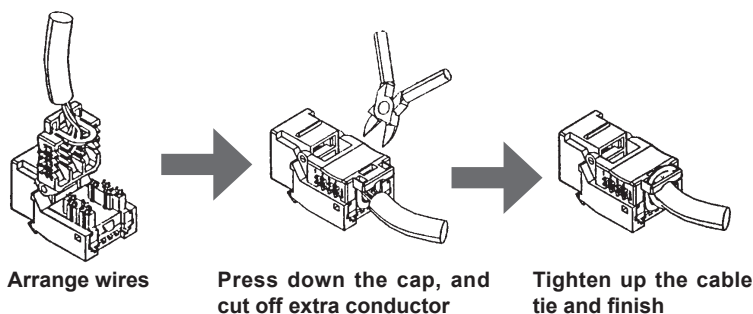

Model No.	Category	Description	Color	Individual packing
7KJ15-CEUSBL	Unshielded CAT.5e	Tool-less Keystone Jack	Blue	Poly Bag
7KJ15-CEUSWH	Unshielded CAT.5e	Tool-less Keystone Jack	White	Poly Bag
7KJ15-C6USBL	Unshielded CAT.6	Tool-less Keystone Jack	Blue	Poly Bag
7KJ15-C6USWH	Unshielded CAT.6	Tool-less Keystone Jack	White	Poly Bag

## ▶ 110 Style Punch Down Keystone Jack



### Specification

- Jack: RJ45 jack, ABS UL94V-0
- Contact: Phosphor bronze, 50u" gold plating over nickel plating in contact area and tinned lead on soldering area
- 110 IDC: PC UL 94V-0, terminal phosphor bronze, and tinned Color code sticker that can combine two T568A & B wiring to save stock and easy installation

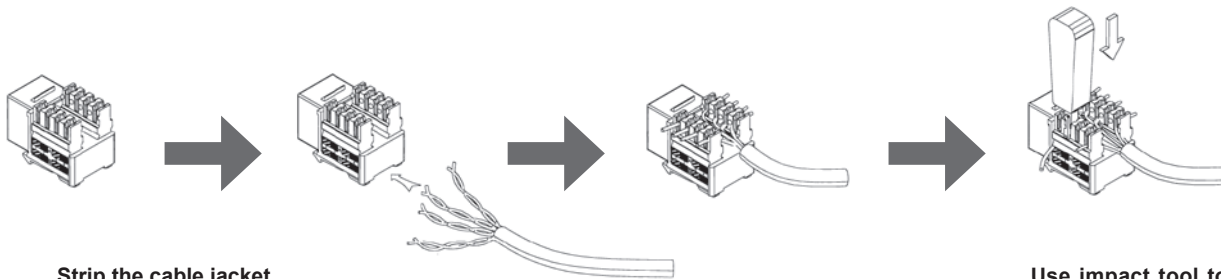

Strip the cable jacket to separate into 4 pairs.

Follow the direction on the color coding sticker to position T568A or B wiring.

Use impact tool to crimp and connect the wires.

Model No.	Category	Description	Color	Individual packing
7KJ8-CEUSBK-Y	Unshielded CAT.5e	Punch Down Keystone Jack	Black	Poly Bag
7KJ8-CEUSBL-Y	Unshielded CAT.5e	Punch Down Keystone Jack	Blue	Poly Bag
7KJ8-CEUSGN-Y	Unshielded CAT.5e	Punch Down Keystone Jack	Green	Poly Bag
7KJ8-CEUSGY-Y	Unshielded CAT.5e	Punch Down Keystone Jack	Gray	Poly Bag
7KJ8-CEUSRD-Y	Unshielded CAT.5e	Punch Down Keystone Jack	Red	Poly Bag
7KJ8-CEUSWH-Y	Unshielded CAT.5e	Punch Down Keystone Jack	White	Poly Bag
7KJ8-CEUSYL-Y	Unshielded CAT.5e	Punch Down Keystone Jack	Yellow	Poly Bag
7KJ8-CEUSIV-Y	Unshielded CAT.5e	Punch Down Keystone Jack	Ivory	Poly Bag
7KJ8-C6USBK-Y	Unshielded CAT.6	Punch Down Keystone Jack	Black	Poly Bag
7KJ8-C6USBL-Y	Unshielded CAT.6	Punch Down Keystone Jack	Blue	Poly Bag
7KJ8-C6USGN-Y	Unshielded CAT.6	Punch Down Keystone Jack	Green	Poly Bag
7KJ8-C6USGY-Y	Unshielded CAT.6	Punch Down Keystone Jack	Gray	Poly Bag
7KJ8-C6USRD-Y	Unshielded CAT.6	Punch Down Keystone Jack	Red	Poly Bag
7KJ8-C6USWH-Y	Unshielded CAT.6	Punch Down Keystone Jack	White	Poly Bag
7KJ8-C6USYL-Y	Unshielded CAT.6	Punch Down Keystone Jack	Yellow	Poly Bag
7KJ8-C6USIV-Y	Unshielded CAT.6	Punch Down Keystone Jack	Ivory	Poly Bag
7KJ3-C3-66WH	CAT. 3	Punch Down Keystone Jack RJ12 6P6C	White	Poly Bag
7KJ3-C3-66IV	CAT. 3	Punch Down Keystone Jack RJ12 6P6C	Ivory	Poly Bag



## ▶ Flush Plate with ICON Slot

The flush plate combines high capacity with multiple connectors, fits all types of standard keystone jacks or connectors with keystone jack mounted devices. The screw cap design provides a more finished look.

### Specification

- Mounting Plate
- Dimension: 70x 115mm (4.5" x 2.75")
- Connector Module insert
- Material: ABS UL94V-0
- Keystone Jack: Fit with all standard keystone jacks



Model No.	Description	Color	Individual packing
7PK-317H1-IV	Horizontal 1 Port Flush Plate	Ivory	Poly Bag
7PK-317H1-WH	Horizontal 1 Port Flush Plate	White	Poly Bag
7PK-317H2-IV	Horizontal 2 Port Flush Plate	Ivory	Poly Bag
7PK-317H2-WH	Horizontal 2 Port Flush Plate	White	Poly Bag
7PK-317H3-IV	Horizontal 3 Port Flush Plate	Ivory	Poly Bag
7PK-317H3-WH	Horizontal 3 Port Flush Plate	White	Poly Bag
7PK-317V1-IV	Vertical 1 Port Flush Plate	Ivory	Poly Bag
7PK-317V1-WH	Vertical 1 Port Flush Plate	White	Poly Bag
7PK-317V2-IV	Vertical 2 Port Flush Plate	Ivory	Poly Bag
7PK-317V2-WH	Vertical 2 Port Flush Plate	White	Poly Bag
7PK-317V3-IV	Vertical 3 Port Flush Plate	Ivory	Poly Bag
7PK-317V3-WH	Vertical 3 Port Flush Plate	White	Poly Bag
7PK-317V4-IV	Vertical 4 Port Flush Plate	Ivory	Poly Bag
7PK-317V4-WH	Vertical 4 Port Flush Plate	White	Poly Bag
7PK-317V6-IV	Vertical 6 Port Flush Plate	Ivory	Poly Bag
7PK-317V6-WH	Vertical 6 Port Flush Plate	White	Poly Bag

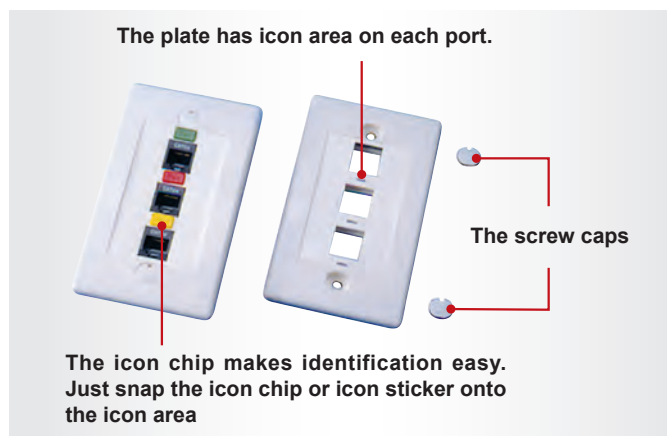

## ▶ 7PK-317ICON Plastic ICON Chip

- Mixed colors: Ivory, White, Red, Blue, Yellow, Green

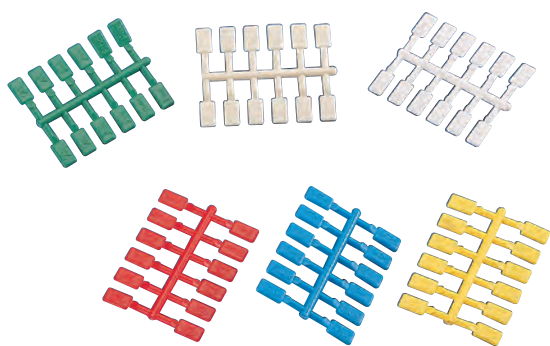

Individual packing
Poly Bag

## ▶ Flush Plate without ICON Slot

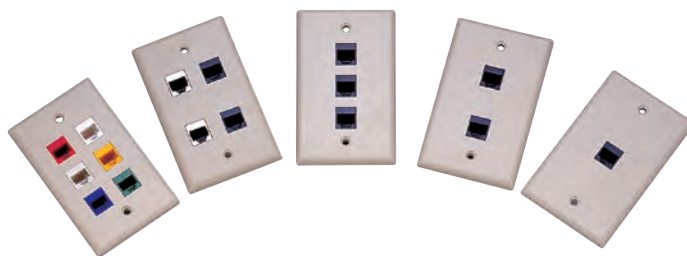

Model No.	Description	Color	Individual packing
7PK-300-1IV	1 Port Flush Plate	Ivory	Poly Bag
7PK-300-1WH	1 Port Flush Plate	White	Poly Bag
7PK-300-2IV	2 Port Flush Plate	Ivory	Poly Bag
7PK-300-2WH	2 Port Flush Plate	White	Poly Bag
7PK-300-3IV	3 Port Flush Plate	Ivory	Poly Bag
7PK-300-3WH	3 Port Flush Plate	White	Poly Bag
7PK-300-4IV	4 Port Flush Plate	Ivory	Poly Bag
7PK-300-4WH	4 Port Flush Plate	White	Poly Bag
7PK-300-6IV	6 Port Flush Plate	Ivory	Poly Bag
7PK-300-6WH	6 Port Flush Plate	White	Poly Bag

## Wall Plate Modules



7MU5-B



7MU5-F



7MU5-BNC

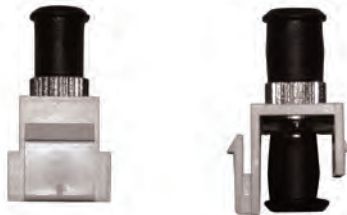

7MU5-ST

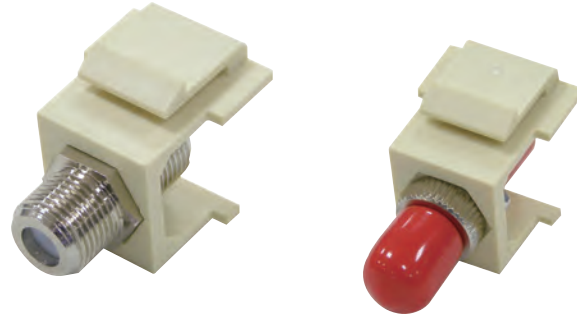

These Keystone Inserts can be fitted into a wide range of plates, such as the flush mounted wall plate in the range of Discrete Snap-In Outlet, unloaded plates in the range of Multimedia Outlet, Unloaded Patch Panel, to meet various requirements exactly in the communication or multimedia wirings.

Model No.	Category	Description	Color	Individual packing
7MU5-BNC-IV	BNC	Feed Thru Modular Insert	Ivory	Poly Bag
7MU5-BNC-WH	BNC	Feed Thru Modular Insert	White	Poly Bag
7MU5-F-IV	F	Feed Thru Modular Insert	Ivory	Poly Bag
7MU5-F-WH	F	Feed Thru Modular Insert	White	Poly Bag
7MU5-ST-IV	ST	Feed Thru Modular Insert	Ivory	Poly Bag
7MU5-ST-WH	ST	Feed Thru Modular Insert	White	Poly Bag
7MU5-B-IV	Blank	Modular Insert	Ivory	Poly Bag
7MU5-B-WH	Blank	Modular Insert	White	Poly Bag

## 7PK-318 Back Box

The back box has just the right space for 6pcs of keystone jacks cabling, also accepts the fiber optics adaptors and jumper connections.

The mounted box can be applied with all standard USA flush plates.

### Specification

- Material: ABS UL94V-0
- Dimension: (L) 115 x (W) 70 x (H) 47mm / (L) 4.50" x (W) 2.76" x (H) 1.85"

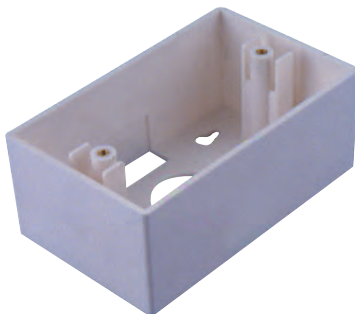

Model No.	Description	Color	Individual packing
7PK-318-IV	Back Box	Ivory	Poly Bag
7PK-318-WH	Back Box	White	Poly Bag

## Cat.6/5e Surface Mounted Box

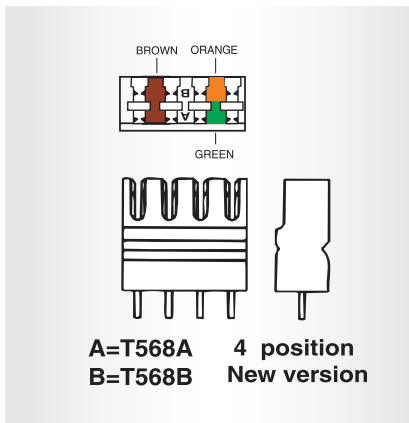

### Color Coding Information

IDC Terminals	T568A Pair/Wire Color	T568B Pair/Wire Color
PIN5 PIN4	1 White/Blue Blue	1 White/Blue Blue
PIN1 PIN2	3 White/Green Green	2 White/Orange Orange
PIN3 PIN6	2 White/Orange Orange	3 White/Green Green
PIN7 PIN8	4 White/Brown Brown	4 White/Brown Brown

### Material:

- Surface Box: ABS UL94V-0
- Jack: RJ45 jack, PBT UL94V-0. Black color, unshielded or shielded jack
- Terminal Block: New version 110, PC UL94V-0
- Color: White

### Cable Tie Chassis

Use cable tie to hold cable jacket tightly to avoid the cable knocking off or pulling away.

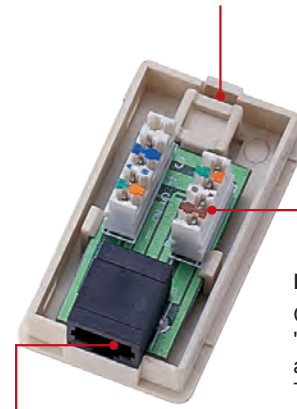

Unshielded RJ45 jack

### New 110 Terminal Block

Can be used for both of "Krone & 110" impact tool and combine with wiring of T568A & B to save stock.

Model No.	Category	Description	Individual packing
7PK-342RCEUS-MWH	Unshielded CAT.5e	Single Port Surface Mounted Box	Poly Bag
7PK-342RCEUS-DWH	Unshielded CAT.5e	Dual Port Surface Mounted Box	Poly Bag
7PK-342RC6US-MWH	Unshielded CAT.6	Single Port Surface Mounted Box	Poly Bag
7PK-342RC6US-DWH	Unshielded CAT.6	Dual Port Surface Mounted Box	Poly Bag

## Keystone Jack Surface Mounted Box

### Specification

- Materials: ABS UL94V-0, ivory or white color
- Mounted Box: Double L50 x W50 x H30 mm (1.97" x 1.97" x 1.19")
- Single : L50 x W30 x H30 mm (1.97" x 1.19" x 1.19")
- Keystone Jack: Fit with all standard keystone jacks

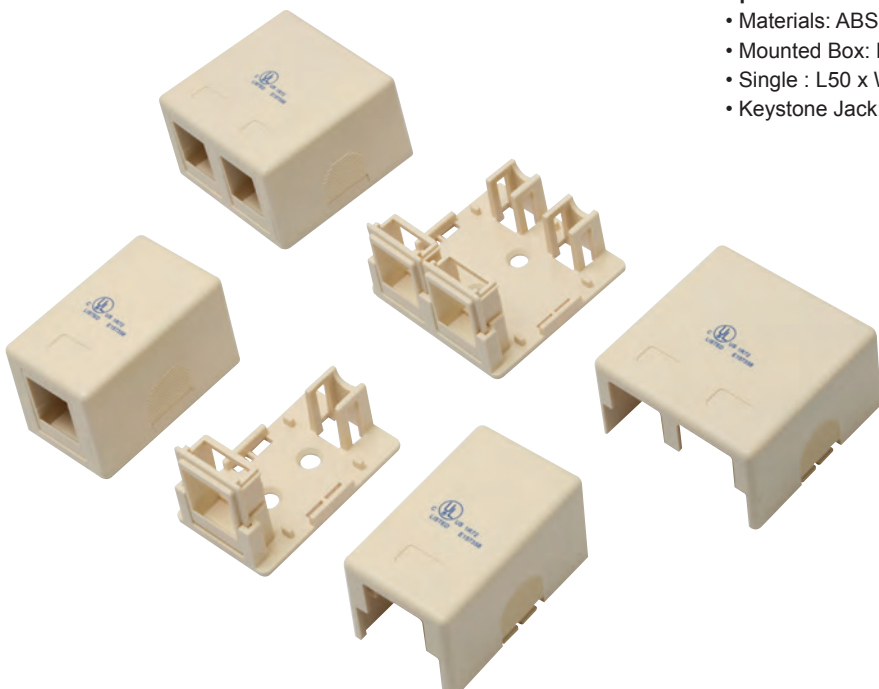

Jack sold separately

Model No.	Description	Color	Individual packing
7PK-301AIV	Single Port Keystone Jack Surface Mounted Box	Ivory	Poly Bag
7PK-301AWH	Single Port Keystone Jack Surface Mounted Box	White	Poly Bag
7PK-302AIV	Dual Port Keystone Jack Surface Mounted Box	Ivory	Poly Bag
7PK-302AWH	Dual Port Keystone Jack Surface Mounted Box	White	Poly Bag

## Inline Coupler

Our inline coupler is ideal to use if you are trying to link to a networking cable run or simply extend your patch cables. Capable of handling LAN speeds up to CAT.5e 100Mbps. The coupler meets TIA/EIA 568A 11801 Category 5e Enhanced & Cat.6 specifications, and available for unshielded and shielded version.



### Specification

- Housing: ABS UL 94V-0, black or white color
- Jack: RJ45, 50u" gold
- Shielded: Phosphor bronze with tin plating
- Dimension: 35(L) x 21(W) x 17(H)mm / 1.38"(L)x 0.83" (W)x 0.67"(H)

Model No.	Category	Description	Color	Individual packing
7PK-315A-CE/BK	Unshielded CAT.5e	Inline Coupler	Black	Poly Bag
7PK-315A-CE/WH	Unshielded CAT.5e	Inline Coupler	White	Poly Bag
7PK-315A-C6/BK	Unshielded CAT.6	Inline Coupler	Black	Poly Bag
7PK-315A-C6/WH	Unshielded CAT.6	Inline Coupler	White	Poly Bag
7PK-315AS-CE	Full Shielded CAT.5e	Inline Coupler	-	Poly Bag
7PK-315AS-C6	Full Shielded CAT.6	Inline Coupler	-	Poly Bag

## ST Connector



Model No.	Description	Individual packing
711-AM-1-9	ST MM, 3.0 mm, Black boot	Poly Bag
711-AS-1-9	ST SM, 3.0 mm, Yellow boot	Poly Bag

Parameter	Condition	Multi mode	Single mode
Insertion Loss	$\lambda = 1300\text{nm}$	<0.5dB	<0.3dB
Return Loss	PC Polish	NA	>35dB
	SPC Polish	NA	>40dB
	UPC Polish	NA	>50dB
	APC Polish	NA	>65dB
Operation Temperature	-20°C to 70°C	0.2dB	0.2dB
Durability	500 cycles	0.2dB	0.2dB
Vibration	10 to 55Hz 1.5mm double amplitude	0.2dB	0.2dB
Temperature Cycle	-20°C to 80°C	0.2dB	0.2dB
Tensile Strength	10kgf	0.2dB	0.2dB

## SC Connector-One Piece Type

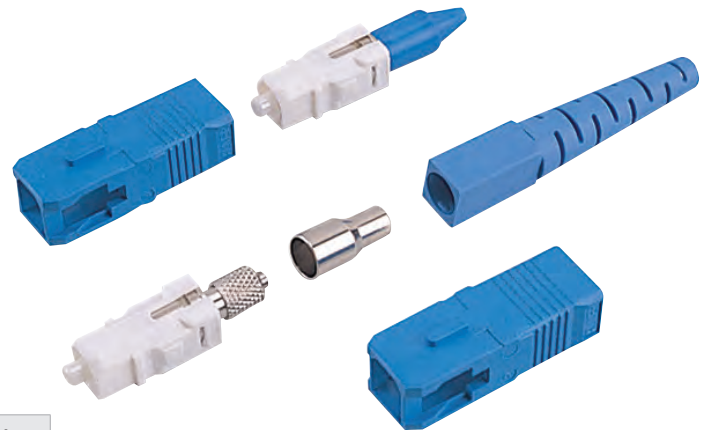

Model No.	Description	Individual packing
711-FM-1-5	SC MM, Ivory housing with 3.0 mm Black boot	Poly Bag
711-FS-1-2	SC SM, Blue housing with 3.0 mm Blue boot	Poly Bag

## SC Duplex Connector - One Piece Type

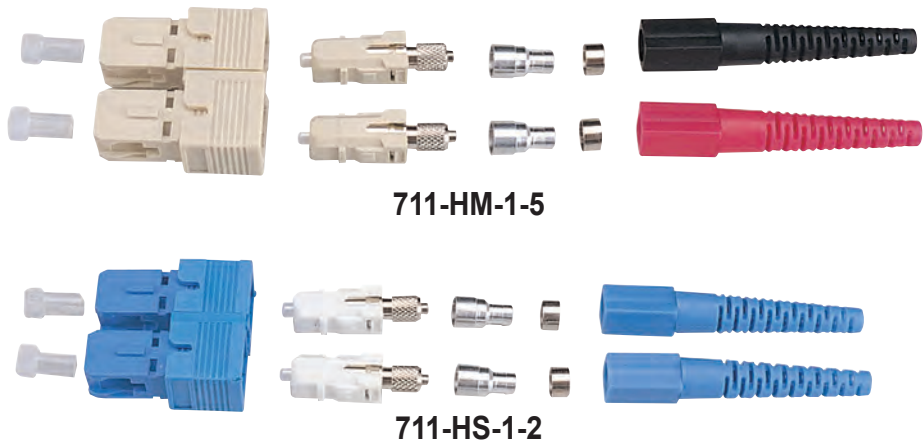

Model No.	Description	Individual packing
711-HM-1-5	SC MM, Duplex, Ivory housing with 3.0 mm Black & Red boot	Poly Bag
711-HS-1-2	SC SM, Duplex, Blue housing, with 3.0 mm Blue boot	Poly Bag

## LC Simplex Connector



Model No.	Description	Individual packing
711-LM-1-1	LC MM, Ivory housing, with 3.0 mm White boot	Poly Bag
711-LS-1-1	LC SM, Blue housing, with 3.0 mm White boot	Poly Bag

## LC Duplex Connector

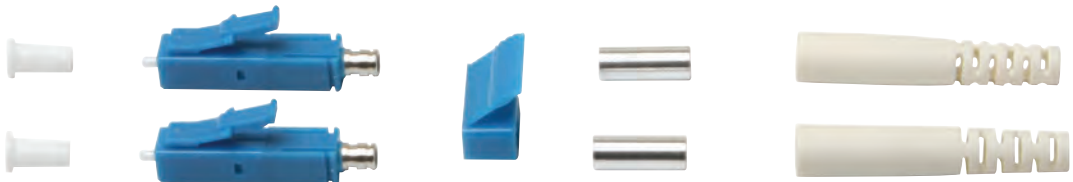

Model No.	Description	Individual packing
711-PM-1-1	LC MM, Ivory housing, with 3.0 mm White boot	Poly Bag
711-PS-1-1	LC SM, Blue housing, with 3.0 mm White boot	Poly Bag

## MTRJ Connector



Model No.	Description	Individual packing
711-MM-1-1	MT-RJ MM, Black housing, with 3.0 mm Black boot (for Round cable)	Poly Bag
711-MS-1-1	MT-RJ SM, Black housing, with 3.0 mm Black boot (for Round cable)	Poly Bag

### ▶ ST Adaptor - Thread Type



Model No.	Description	Individual packing
715-01S1-1	ST SM Adaptor with Zirconia sleeve (Thread type)	Poly Bag

### ▶ SC Adaptor-Simplex Type



Model No.	Description	Individual packing
715-07S1-1	SC SM Adaptor Blue housing with Zirconia sleeve (Flange type)	Poly Bag

### ▶ ST Adaptor- Flange Type



Model No.	Description	Individual packing
715-02S1-1	ST SM Adaptor Blue housing with Zirconia sleeve (Flange type)	Poly Bag

### ▶ ST Adaptor- Duplex Type

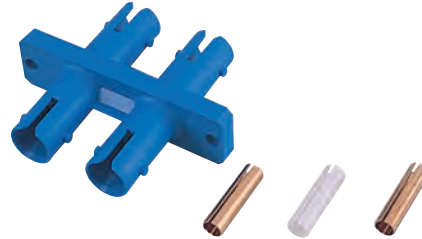

Model No.	Description	Individual packing
715-03M1-3	ST MM Duplex Adaptor, Ivory housing with Phosphor Bronze sleeve (Flange type)	Poly Bag
715-03S1-1	ST SM Duplex Adaptor, Blue housing with Zirconia sleeve (Flange type)	Poly Bag

### ▶ SC Adaptor- Duplex Type

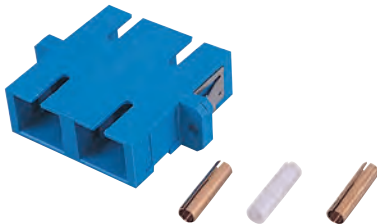

Model No.	Description	Individual packing
715-08M1-3	SC MM Duplex Adaptor, Ivory housing with Phosphor Bronze sleeve (Flange type)	Poly Bag
715-08S1-1	SC SM Duplex Adaptor, Blue housing with Zirconia sleeve (Flange type)	Poly Bag

### ▶ ST to SC Adaptor



Model No.	Description	Individual packing
715-10M1-3	ST to SC MM Adaptor, Ivory housing with Phosphor Bronze sleeve (Flange type)	Poly Bag
715-10S1-1	ST to SC SM Adaptor, Blue housing with Zirconia sleeve (Flange type)	Poly Bag

### ▶ ST to SC Duplex Adaptor



Model No.	Description	Individual packing
715-12M1-3	ST to SC Duplex Adaptor, Ivory housing with Phosphor Bronze sleeve (Flange type)	Poly Bag
715-12S1-1	ST to SC Duplex Adaptor, Blue housing with Zirconia sleeve (Flange type)	Poly Bag

### ▶ LC Adaptor



Model No.	Description	Individual packing
715-15M1-3	LC MM Simplex Adaptor, Ivory housing with Phosphor Bronze sleeve	Poly Bag
715-15S1-1	LC SM Simplex Adaptor, Blue housing with Zirconia sleeve	Poly Bag



# CONNECTORS



# CAT 6-100

## RJ45 Cat.6 Plug w/Inserter 100pk

CAT6-100 connectors can be used for both CAT5 and CAT6 stranded RJ45 Cables. These connectors come with insertion guide for ease of use.

weight: 0.3 lbs



Stranded Wire



Strip away outer shielding from the RJ45 cable. Cut away the exposed spine found inside CAT6 cables.

**Recommended Tool:**  
902-229  
Universal Stripper



Arrange wires according to chart below. (568-B method)



Cut the arranged wires on a sharp angle and feed through the insertion guide.

**Recommended Tool:**  
100-035  
Kevlar Cutting Scissors



Cut the excess wires flush with the end of the insertion guide.



Feed the insertion guide all the way to the end of the connector. While using the 568-B method keep the clip facing down and the brown wire to the right.



To Finish, crimp your connector onto your CAT6 cable.

**Recommended Tool:**  
300-063  
Modular Plug Crimper



## Other Modular Plugs

<b>To Select Proper Plug</b>	<b>Step 1</b> Pick the number of positions in block and number of pins loaded in block.
	<b>Step 2</b> Choose flat or round cable
	<b>Step 3</b> Choose Stranded or Solid conductors (wire)
	<b>Step 4</b> Choose Premium Grade or Economy Grade - Gold thickness is only difference
	<b>Step 5</b> Choose Pack Quantity (retail pack of 50 pcs or Bulk bag of 1,000 pcs.)

Pos/Contacts	Cable Type	Wire Type	Premium Grade 50 uin Gold		Economy Grade Thin Gold Flash	
			Clamshell (50pcs)	Poly bag (1000pcs)	Clamshell (50pcs)	Poly bag (1000pcs)
4P4C	Flat	Stranded	702-001	744-FA50	702-059	744-FA03
6P4C	Round	Stranded	-	-	702-063	764-RA03
	Round	Solid	702-018	764-RX50	-	-
8P8C	Flat	Stranded	702-008	788-FA50	702-066	788-FA03
	Round	Stranded	702-009	788-RA50	702-067	788-RA03
	Flat	Solid	702-021	788-FX50	702-079	788-FX15
	Round	Solid	702-022	788-RX50	702-080	788-RX15
10P10C	Round	Stranded	702-013	700-RA50	-	-

## Telecom Splices

- Use Crimp Tool P/N 100-008



UR AWG  
26~20

UG AWG  
19~26

UY AWG  
26~22

Individual  
packing

Poly Bag

- Silicone gel filled for protection from elements

Model No.	Description	Package Quantity
703-001	UY Connectors	1,000 Pc. Outer box with ten 100pc box
703-003	UY Connectors	100 Pc. Clamshell
703-005	UY Connectors	25 Pc. Clamshell

Model No.	Description	Package Quantity
703-002	UR Connectors	1,000 Pc. Outer box with ten 100pc box
703-004	UR Connectors	100 Pc. Clamshell
703-006	UR Connectors	25 Pc. Clamshell

Model No.	Description	Package Quantity
703-007	UG Connectors	1,000 Pc. Outer box with ten 100pc box
703-008	UG Connectors	100 Pc. Clamshell
703-009	UG Connectors	25 Pc. Clamshell

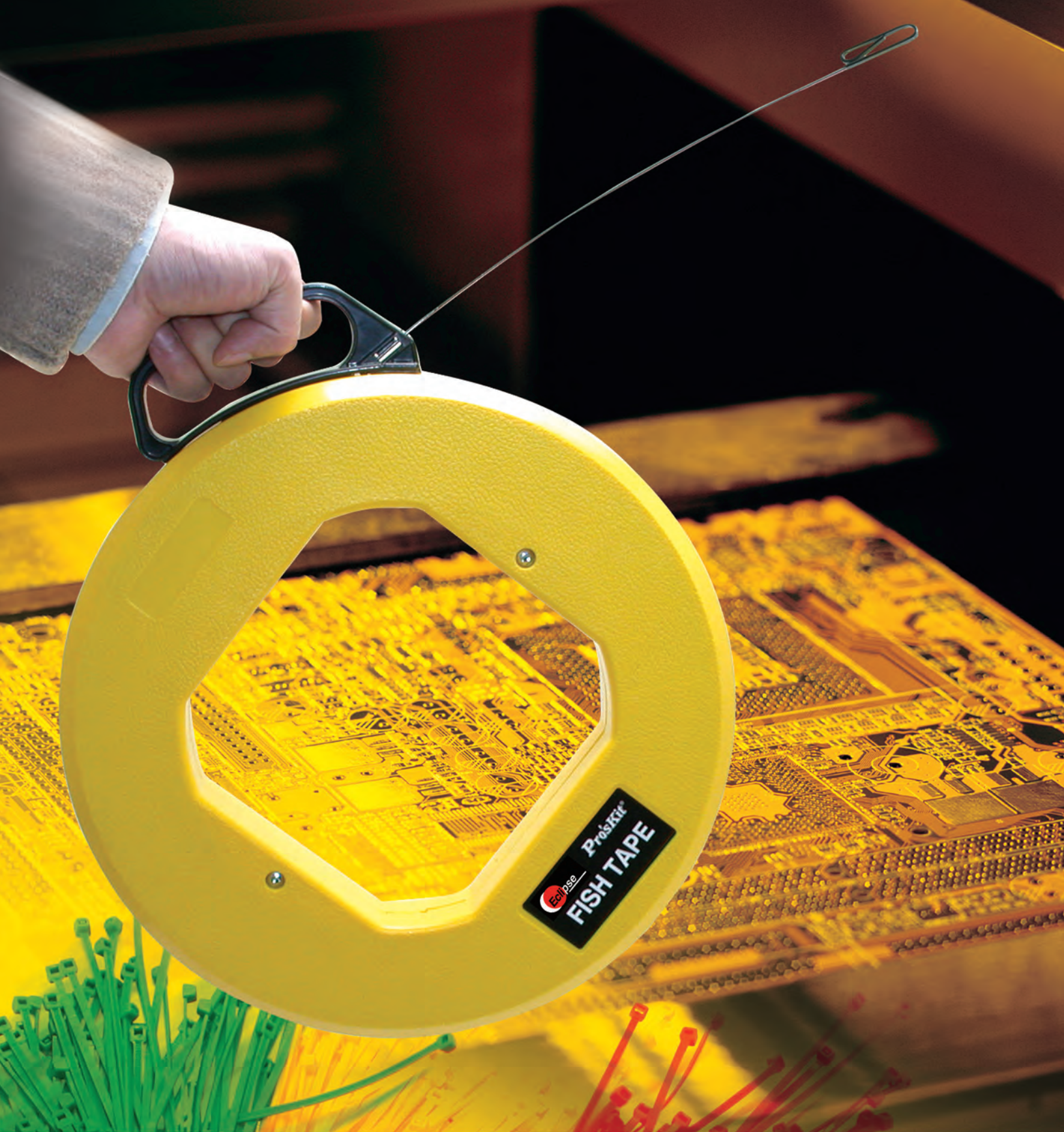

# WIRING INSTALLATION

▶ 900-147/900-148/900-149 **Fish Tape**



900-147



900-148



900-149

Model No.	Steel tape size	Individual packing
900-147	50 Feet	PE shrink
900-148	100 Feet	PE shrink
900-149	200 Feet	PE shrink

- Made from flexible spring steel and black finish.
- Equipped with durable plastic container and slide handle.
- Easy to thread through the pipe and pull out the electric cable.

▶ 902-197 **Fiberglass Fish Tape**



Fiberglass tape size	Individual packing
150 Feet	PE shrink

▶ DK-2053A **Fiberglass Push/Pull Rod Set (10 Pcs/set)**



Ceiling ducts



Under floorboards



Trunking



Wall cavities



Hook



Ring

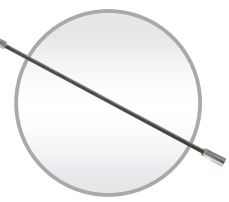

Flexible Extender

Replacement Parts: 9DK-2053A-B  
(3pcs/set Includes: Hook, Ring & Extender)

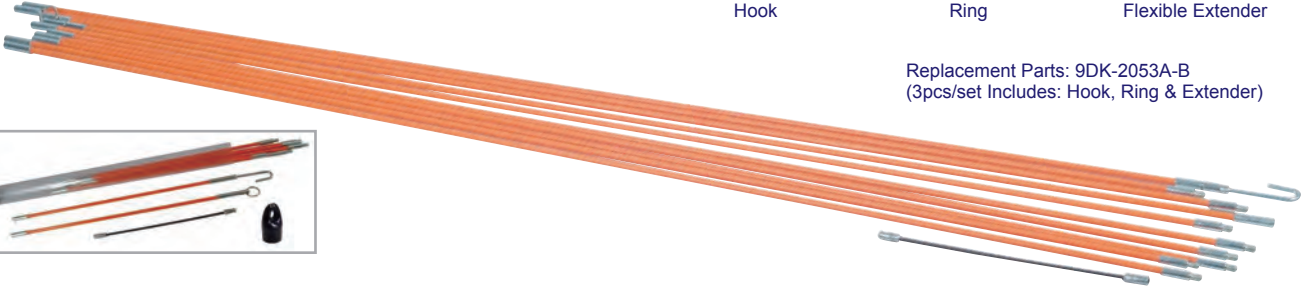
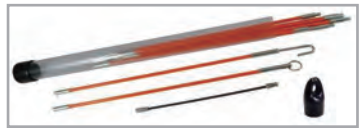

Description	Individual packing
3.28 feet, 10pcs/set	PVC tube

- Ideal for running multi-purpose cable in hard-to-reach area such as behind walls, up through crawl spaces, and under floors.
- 10 pcs, 1M/3.28Ft each
- Diameter 5mm±0.2mm (13/64"±0.008" )

## ▶ CP-391 All In One Cable Tacker



Interchangeable staple guide plate

- For insulated staples only.

### CP-391-1

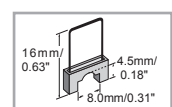

- Round Cable  
Height: 4mm~6mm (0.16\"~0.24\")
- Flat Wire  
Height: 2.5mm~4.0mm  
Width: Below 8.0mm

### CP-391-2

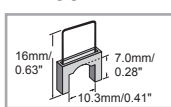

- Round Cable  
Height: 6mm~8mm(0.24\"~0.31\")
- Flat Wire  
Height: 4.5mm~6.3mm(0.18\"~0.25\")  
Width: Below 10.3mm(0.41\")



STEP 1  
Press the staple feeder downward and remove from its channel.



STEP 2  
Load a strip of staples into the channel.



STEP 3  
Slide in the staple feeder and push it upward to its locked position.



- All in one cable tacker can work with different kinds of round cables and flat wires.
- Easy way to change different staple guide plates to match different staples (CP-391-1 or CP-391-2)

Material	OAL. (mm/inch)	Replacement staples	Individual packing
ABS	180x30x148 7.1x1.2x5.8	CP-391-1 (200pcs/pack) CP-391-2 (200pcs/pack)	Blister card

## ▶ CP-392 Heavy Duty 3 In 1 Tacker



- Works with Arrow brand T25 staples.

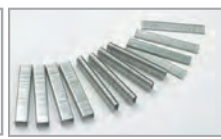

- 1.Flat crown staples 4-14mm(5/32\"-9/16\") 200pcs
- 2.Round crown staples 10-12mm(3/8\"-1/2\") 200pcs
- 3.Brad Nails 10-14mm(3/8\"-9/16\") 200pcs

- Easy-squeeze product works overtime as a staple gun, brad nailer, cable tacker and wire tacker
- Fastens 3 different types of staples: flat crown staples, round crown staples and brad nails
- Ideal for upholstery, wood working, ceiling tiles, rack & roofing
- Adjustable punch force to match different material hardness.
- Less force to squeeze and more driving power
- Non-slip grip and quick jam release
- Made of all carbon steel construction.

### CP-392-3 Flat Crown Staples

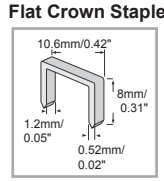

500pcs/box

### CP-392-4 Round Crown Staples

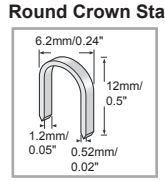

500pcs/box

### CP-392-5 Brad Nail



1000pcs/box

Material	OAL. (mm/inch)	Replacement staples	Individual packing
Carbon steel	160x23x140 6.3x0.9x5.5	CP-392-3 (500pcs/box) CP-392-4 (500pcs/box) CP-392-5 (1000pcs/box)	Blister card

### ▶ CP-382 Cable Tie Gun



- Neatly cuts end of cable tie off
- Adjustable tension control



Material		HRC	Application	OAL. (mm/inch)	Individual packing
Body	Blade				
Aluminum	S45C	Cutter 48°±2°	Cable tie from 3/32"~3/16"(2.2~4.8mm) and thickness up to 1.6mm	160/6.3	Blister card

### ▶ CP-383 Cable Tie Gun



**Features:**

- Adjustable tension control can be used for a variety of style cable ties
- Consistent flush cut with each use
- Durable die-cast steel construction

**Cable Tie:**

- Thickness up to 1.3mm(0.05")
- Width up to 4.6mm(0.18")



Material	O.A.L. (mm/inch)	Individual packing
Steel	168/6.6	Blister card

### ▶ CP-385 Cable Tie Fasten Tool



- Tension adjustment allows the user to adapt the tool to the size of the tie
- Cutting lever design to cut-off the excess tie for easy operation



Tension



Cutting

Material		Application	OAL. (mm/inch)	Individual packing
Body	Blade			
Aluminum	S45C	cable ties thickness 3 mm and width 12mm	191/7.5	Blister card

### ▶ 902-321 Stainless Steel Cable Tie Gun

- Ideal for tensioning and cutting off stainless steel cable ties both in ball lock and ladder types.
- Heavy duty, two stage manual tensioning tool for easy operation
- OAL: 8.2"



Cable tie holder is specially made of SKD11 steel and CNC ground

Cutting blade is made of SKD11 and CNC ground

Cable control bar

Self return spring design

Made of Carbon Steel

Non-slip TPR handles



Tensioning and cutting off stainless steel cable ties



Suitable for most application fields of stainless steel cable ties. And up to 12mm wide.

Individual packing
Blister Card



# TOOL CASES

## ▶ 900-262 Heavy-Duty ABS Case With Wheels And Telescoping Handle

- Heavy-duty black scuff resistant molded ABS thermoplastic forms the tough shell of this case.
- Extruded aluminum rim, drawbolt key locks and strong molded handle.
- Complete with one removable pallet and removable interior dividers.
- Locking telescoping handle extends to 1000mm.
- Loading capacity : max 12kg/26Lb
- Rotationally molded heavy-duty polythylene shell.



Rugged and comfortable grip handle



Key locks for maximum security



Standard equipment for easy opening and closing.

### Assemble

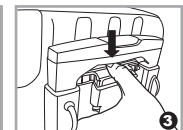
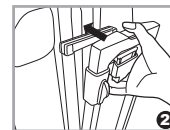
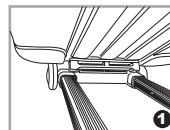

Material	Loading Capacity	Dimension (mm/inch)	Individual Packing
ABS	12Kg/26Lb	456x190x335/18.3x7.5x13.2	Color Box

## ▶ TC-131 Heavy Duty Luggage Cart

- Fold flat for easy storage.
- Open quickly to hold up to 150lbs/68kg.
- Soft comfortable grip hand.
- Extra sturdy and lightweight construction.
- 125mm/4.9" large heavy duty wheels to go up and down stairs and curbs easily.
- Includes 2pcs on 100cm/3.9" stretch band.



Loading Capacity	Material	
68Kg (150lbs)	Body: Metal Platform: Aluminum steel Wheel: PP+TPU	
Dimension (mm/inch)	Weight (kg)	Individual Packing
Fold: 385x 64x 763/15.2x2.5x30 Open: 385x 420x 1010/15.2x16.5x39.8 Platform: 385x280x6/15.2x11x0.24	3.5	Bulk

## ▶ TC-765 Aluminum Frame Drawer Case



- Made of rugged plastic for strength and durability .
- Sturdy aluminum frame construction.
- The drawer locks automatically when lid is closed to prevent slide out for easy mobility.
- Ball-bearing slides make drawer easy to open and close tightly.
- Non-slip lining helps you to keep tools in place.
- Cushioned carrying handle for user comfort.
- Comes with drawers at the bottom perfect to store small gadgets and tiny tools.



Cushioned Carrying handle



Heavy duty metal protective corners



Ball-bearing slides make drawer easy to open and close tightly



Drawer auto-locking design when lid is closed to prevent slide out



Key locks for maximum security

Size	L (mm/inch)	W (mm/inch)	H1 (mm/inch)	H2 (mm/inch)	A	Individual packing
O.D	430/16.9	300/11.8	163/6.4	57/2.2	90°	Color box
I.D	410/16.1	280/11.0	70/2.8	49/1.9		
I.D(Drawer)	337/13.3	255/10.0	40/1.6	-		

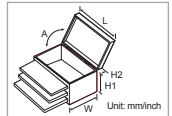

## ▶ 900-048 Aluminum Frame Tool Case W/1 Pallet



- Complete with one removable pallet and removable interior dividers
- Lining and partitions: EVA



3 hinges reinforce construction



Rugged and comfortable grip handle



Heavy duty metal protective corners



Bag with rivet design, more durable

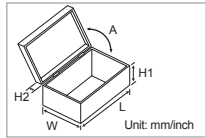

Material	Size	L (mm/inch)	W (mm/inch)	H1 (mm/inch)	H2 (mm/inch)	A	Second Pallet	Individual packing
Frame: Aluminum	O.D	458/18.0	330/13.0	90/3.5	60/2.4	97°	900-045	Plain box + Color box
	I.D	434/17.1	308/12.1	82/3.2	53/2.1			

## ▶ 900-141 ABS Carrying Tool Case W/2 Pallet



- Complete with two removable pallets and removable interior dividers.



Deluxe die-cast chrome golf grip handle



Key locks for maximum security



Bag with rivet design, more durable

Material	Size	L (mm/inch)	W (mm/inch)	H1 (mm/inch)	H2 (mm/inch)	A	Individual packing
ABS	O.D	435/17.1	310/12.2	80/3.14	65/2.6	105°	Color box
	I.D	420/16.5	293/11.5	70/2.8	60/2.4		

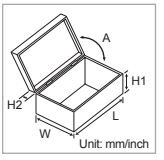



## ▶ 900-203 Aluminum Frame Tool Case

- With removable interior dividers
- Lining and partitions: EVA

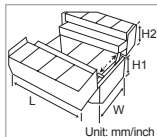

Size	Material	L (mm/inch)	W (mm/inch)	H1 (mm/inch)	H2 (mm/inch)	Individual packing
O.D	Frame:	360/14.2	220/8.7	120/4.7	110/4.3	Plain box + Color label
I.D	Aluminum	335/13.2	200/7.9	110/4.3	85/3.3	

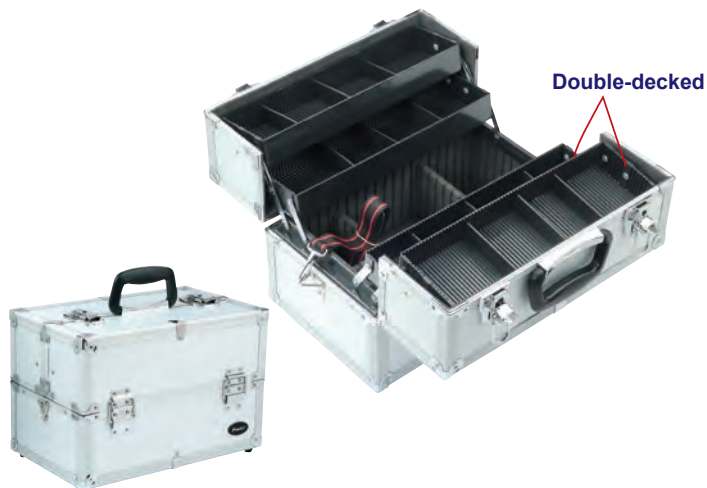

## ▶ 900-199 ABS Carrying Tool Case W/1 Pallet

- Attractive and functional multipurpose cases
- Functional for both personal and professional business.
- Complete with one removable pallet and removable interior dividers
- Both the tool pallet and dividers are removable.
- Injection molding tool case stands.
- Aluminium corner frames to protect tools.
- Lining and partitions: EVA



Key locks for maximum security



Rugged and comfortable grip handle

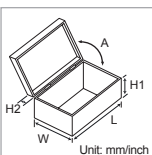

Size	Material	L (mm/inch)	W (mm/inch)	H1 (mm/inch)	H2 (mm/inch)	A	Individual packing
O.D	ABS	463/18.2	331/13.0	96/3.8	75/3.0	98°	Color box
I.D		453/17.8	323/12.7	90/3.5	67/2.6		



Heavy duty metal protective corners

## ▶ 900-011 Aluminum Frame Tool Case W/1 Pallet

- Complete with one removable pallet and removable interior dividers
- Lining and partitions: EVA



Bag with rivet design, more durable



Rugged and comfortable grip handle

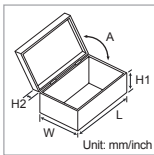

Size	Material	L (mm/inch)	W (mm/inch)	H1 (mm/inch)	H2 (mm/inch)	A	Second Pallet	Individual packing
O.D	Frame:	458/18.0	330/13.0	101/4.0	49/1.9	97°	900-045	Color box
I.D	Aluminum	438/17.2	312/12.3	95/3.7	41/1.6			



Key locks for maximum security

▶ **900-054 2 In 1 Zipper Bag W/2 Pallet**



Front Side



Back Side

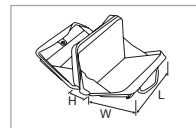

Material	L (mm/inch)	W (mm/inch)	H (mm/inch)	Individual packing
PVC leather	400/15.7	300/12	120/4.7	Poly bag

▶ **900-052 Heavy Duty Zipper Bag**



Front Side



Back Side

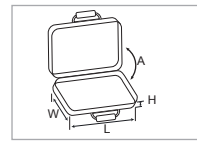

Material	L (mm/inch)	W (mm/inch)	H (mm/inch)	A	Individual packing
PVC leather	435/17.1	325/12.8	90/3.5	93°	Color box

▶ **900-225 Blow Molded Case With Pre-Cut Soft Foam**

- Material: H.D.P.E



Demo only



Inside dimensions:  
 Base 15-5/8" X 8-3/4" at the top, 15-1/4" X 8-1/2" at the bottom, 2-1/2" deep  
 Top 16-1/2" X 9-5/8" , 3/4" deep

L (mm/inch)	W (mm/inch)	H (mm/inch)	Individual packing
442/17.4	279/11.0	89/3.5	Color Label

## ▶ 902-118 Zipper Bag W/2 Pallets

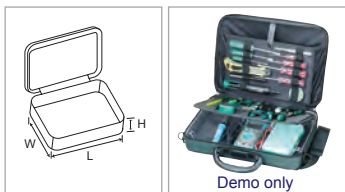

Material	L (mm/inch)	W (mm/inch)	H (mm/inch)	Individual packing
PVC leather	390/15.4	280/11.0	70/2.8	Color box



## ▶ 902-119 Tool Bag

- Intensive structure for strap, zipper and handle designed to enhance the durability, ideal for student market.

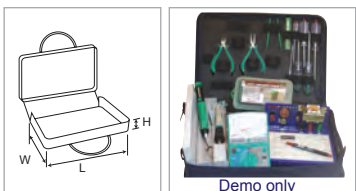

Material	L (mm/inch)	W (mm/inch)	H (mm/inch)	Individual packing
600D polyester	390/15.4	260/10.2	110/4.3	Poly bag



Water repellent

**Convenient • Portable • Durable**

## ▶ 900-260 Tool Bag

- Multi function bag with 4 inner layers ideal for storing tools, books, mobile computers, clothes, etc.



Material	L (mm/inch)	W (mm/inch)	H (mm/inch)	Individual packing
600D polyester	400/15.7	275/10.8	90/3.5	Poly bag



Water repellent

**Convenient • Portable • Durable**

### ▶ MTB-1 Mechanic's Tool Bag

- Material: 600D Polyester
- Rugged construction
- Heavy-duty zipper
- Sturdy padded handles
- Hard bottom to maintain shape
- Soft sides to allow flexibility
- 13 pocket holes for versatility

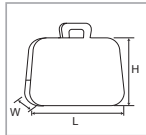

Demo only

Material	L (mm/inch)	W (mm/inch)	H (mm/inch)	Individual packing
600D Polyester	305/12.0	152/6.0	165/6.5	Poly bag

### ▶ 900-246 Soft Sided Tool Pouch

- Keep your tools and supplies handy.
- Made from strong durable fabric.
- complete with universal tool belt system.



Demo only

Dual purpose belt for easy carrying on shoulder or waist

Size	L (mm/inch)	W (mm/inch)	H (mm/inch)	Individual packing
O.D	305/12.0	235/9.3	95/3.7	Poly bag + Hanger

### ▶ 902-314 25 Pocket Electrical & Maintenance Tool Carrier

- Made of 600D polyester
- With a padded carrying handle
- With multi-pocket for versatility
- A space in the bottom for storage box



Square design enables standing with stability



Material	Dimension (mm/inch)	Individual packing
600D Polyester	216x216x406mm/8.5"x8.5"x16"	Poly bag+Hanger

### ▶ 902-311 Master Tool Belt

- Made of 600D polyester
- Leather waist belt with 13 adjustment holes (from 32" to 44")
- With roller metal double-tongue buckle
- With multi-pocket for versatility



Demo only

Material	Dimension (mm/inch)	Individual packing
600D Polyester	356x330mm/14.0"x13.0" (Individual bag size)	Poly bag+Hanger

## ▶ ST-38A/ST-28A Portable Hard Shell Case

- Made of lightweight and durable Polyethylene terephthalate, Eco-friendly material, anti-pollution
- PET material hard shell case provides optimal device protection, features anti-dust and water repellent
- Inside mesh interior pocket for easy accessories or small stuffs collection
- Stylish design with practical functionality, easy way to reorganize your own stuffs

**NEW**



(Demo only)

ST-38A



(Demo only)

ST-28A

Model No.	Material	L (mm/inch)	L (mm/inch)	H (mm/inch)	Individual packing
ST-18A	Polyethylene terephthalate	357/14.1"	275/10.83"	65/2.56"	Color sleeve-shrink
ST-28A		218/8.58"	130/5.12"	70/2.76"	

## ▶ 9ST-902 Zipper Bag



Demo only

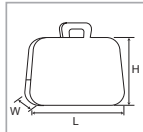

Material	L (mm/inch)	W (mm/inch)	H (mm/inch)	Individual packing
PVC leather	260/10.24	170/6.69	38/1.5	Poly bag

## ▶ ST-5601 Magnetic Wrist Band



Powerful magnet lifts: 1kg



Water repellent



Demo only



Material	Dimension (mm/inch)	Individual packing
600DX600D Polyester	Width: 5cm / Length: 30cm (Width: 2.0" / Length: 11.8")	Poly bag+Hanger

## ▶ 902-312 4 Pocket Pouch

- Made of 600D polyester
- 3 mesh pockets for light tools
- Ideal for packing pliers with a padded & reinforced pouch design



Demo only

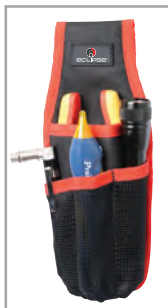

Material	Dimension (mm/inch)	Individual packing
600D Polyester	229x102mm/9.4"x4.0"	Poly bag+Hanger

## ▶ ST-5203 Power Tool Holster

- Made of lightweight and durable polyester
- Provides extra strength and carrying confort



Water repellent



Demo only



Material	Loading capacity	Dimension (mm/inch)	Individual packing
600DX600D Polyester	3kg	280x180x50/11.0x7.1x2.0	Poly bag+Hanger



# TOOL KITS

## ▶ 902-121 8 Pc Compact Tool Kit

### 902-121 contents

Dual color long nose plier 136mm (5.4")

Dual color diagonal cutting Plier 115mm (4.5")

⊕ Precision screwdriver #0x20mm (#0x0.79")

⊕ Precision screwdriver #00x20mm (#00x0.79")

⊖ Precision screwdriver 2.0x20mm (2.0x0.79")

⊖ Precision screwdriver 3.0x20mm (3.0x2.79")

⊕⊖ Double-end reversible screwdriver #2/6 mm

Fine tip straight tweezer

Zipper carrying bag

• Case size: 207x127.5x40mm (8.15"x5.02"x1.57")

• Individual packing: Color sleeve shrink



## ▶ 500-025 10 Pc Compact Tool Kit

### 500-025 contents

Long nose plier 135mm (5.3")

Diagonal cutting plier 110mm (4.3")

Fine tip straight tweezer

⊖ Pro-soft s/d 3.2x75mm (3.2x3.0")

⊕ Pro-soft s/d #0x75mm (#0x3.0")

Precision screwdriver 2.4mm

Precision screwdriver #0

Needle file flat

Needle file round

Utility knife (3 blades self loading)

Zipper carrying bag

• Case size: 205x144x35mm (8.1"x5.7"x1.4")

• Individual packing: Inner box & Color label shrink



## ▶ PK-ST902 4 Pc Ergonomic ESD Safe Plier And Cutter Kit



- Made of high-quality carbon steel with nickel plating
- ESD safe, soft touch cushioned handle provides a secure hold and comfort
- With double leaf springs for self-opening action

### PK-ST902 contents

5" Bent nose

4 1/2" Diagonal cutting

4 1/2" Pointed diagonal pliers

5" Flat nose pliers

Zipper carrying bag

• Case size: 207x127.5x40 mm (8.15"x5.02"x1.57")

• Individual packing: Color label+Shrink



• NOTE : For quality reason, we reserve the right to change the above specifications without notice.

▶ **500-047 13 Pc Basic Electronics Kit**



500-047 contents
Lineman's plier 160mm (6.3")
Side cutting plier 160mm (6.3")
Long nose plier 165mm (6.5")
6" Adjustable wrench
Desoldering wick
Solder core 63%, SN
⊖ Pro-soft screwdriver 3.0x100mm (3.0x4.0")
⊕ Pro-soft screwdriver #0x100mm (#0x4.0")
⊕ Pro-soft screwdriver #2x100mm (#2x4.0")
⊖ Pro-soft screwdriver 5.0x100mm (5.0x4.0")
⊕ Pro-soft screwdriver #1x100mm (#1x4.0")
Convertible soldering iron/gun 110V
Fine tip straight tweezer
Zipper carrying bag

- Case size: 195x305x50mm (7.7"x12.0"x2.0")
- Individual packing: Color sleeve shrink

▶ **500-003 28 Pc Computer Service Tool Kit**



500-003 contents
Long nose plier 135mm(5.3")
Diagonal cutting plier 110mm(4.3")
Fine tip straight tweezer
3 pcs Soldering aid tools
6" Adjustable wrench
Quick heat ceramic soldering iron 110V
Screwdriver handle
⊖ Pro-soft s/d 5.0x75mm(3.0")
⊕ Pro-soft s/d #1x75mm(3.0")
Desoldering wick
Crimping tool (inch)
Desoldering pump
IC extractor
3 prong holder
IC insert tool
Solder core 63%, SN
Parts tube
Heat sink
8 pcs bits pack
Zipper carrying bag

- Case size: 325x195x48mm(12.8"x7.7"x1.9")
- Individual packing: Inner box & Color label shrink

▶ **500-042 16 Pc ESD Precision Tool Kit**



This precision plier series is made of high quality SK7, accurately machined design.

500-042 contents
Long nose plier
Flat nose plier
Bent nose plier
Clean cut micro nipper
Micro cutting plier 125mm (4.9")
4 pcs conductive tweezers set
Wrist strap 10FT
⊕ ESD safe precision screwdriver #00
⊕ ESD safe precision screwdriver #0
⊕ ESD safe precision screwdriver #1
⊖ ESD safe precision screwdriver 2.0mm
⊖ ESD safe precision screwdriver 2.4mm
⊖ ESD safe precision screwdriver 3.0mm
Tool bag

- Case size: 340x222.5x60mm (13.4"x8.8"x2.4")
- Individual packing: Inner box & Color label shrink

• NOTE : For quality reason, we reserve the right to change the above specifications without notice.



## ▶ 500-016 18 Pc School Tool Kit

500-016 contents
Utility component storage box
Fine tip straight tweezer
Side Cutter 125mm (4.9")
Long nose plier 138mm (5.4")
Quick heat ceramic soldering iron 110V
⊖ Pro-soft s/d 3.2x75mm (3.0")
⊕ Pro-soft s/d #0x75mm (3.0")
⊖ Pro-soft s/d 5.0x75mm (3.0")
⊕ Pro-soft s/d #1x75mm (3.0")
⊖ Pro-soft s/d 6.0x100mm (4.0")
⊕ Pro-soft s/d #2x100mm (4.0")
Brush
Mini soldering stand with sponge
Desoldering pump
IC extractor
7 pcs folding type hex key set (inch)
Solder core 63%, SN
Utility knife (3 blades self loading)
Zipper carrying bag

- Case size: 330x220x48mm (13.0"x8.7"x1.9")
- Individual packing: Inner box & Color label shrink



## ▶ 500-032 24 Pc Professional Electronic Tool Kit

500-032 contents
Lineman's plier 165mm (6.5")
Side cutter 125mm (4.9")
Long nose plier 160mm (6.3")
Soldering iron stand with sponge
Desoldering pump
Quick heat ceramic soldering iron 110V
⊖ Line color screwdriver 3.2x75mm (3.0")
⊕ Line color screwdriver #0x75mm (3.0")
⊖ Line color screwdriver 5.0x75mm (3.0")
⊕ Line color screwdriver #1x75mm (3.0")
⊖ Line color screwdriver 6.0x100mm (4.0")
⊕ Line color screwdriver #2x100mm (4.0")
⊖ Line color screwdriver nut 3/16"
⊕ Line color screwdriver nut 1/4"
6 pcs electronic screwdriver set
3-1/2 compact digital multimeter
7 pcs folding type hex key set (inch)
PVC insulated tape
Solder core 63%, SN
Zipper carrying bag

- Case size: 375x250x60mm (14.8"x9.8"x2.4")
- Individual packing: Inner box & Color label shrink



TWEEZERS

MAGNIFICATION &amp; LIGHTING

FIBER OPTICS

POWER TOOLS

MISCELLANEOUS

INSTRUMENT CASES

LAN/DATACOMM

CONNECTORS

WIRING INSTALLATION

TOOL CASES

TOOL KITS

Index

## PK-2061 Solar MC3 & MC4 Crimping Tool Kit

**Pb** This is a complete tool kit to install MC3 & MC4 solar connectors easily and accurately.

To open the locking device  
To secure

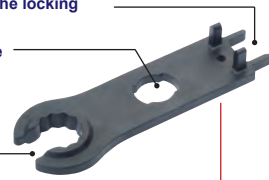

Includes 2 pcs MC4 and MC4 PLUS open-end spanner and unlocking tool help you opening the locking device, securing and tightening the cable gland.

Universal solar cable stripper comes with adjustable length stop for reliable stripping of the double layer insulated cable gland (2.5 - 6.0 mm<sup>2</sup>)



To tighten the cable gland



The Parallel action crimper features consistent and accurate performance

Heavy duty Forged Cable Cutter with high leverage Jaw and shear blade for clean cut without damage.

Prosoft screwdrivers for PV junction box installation



### Contents:

Parallel Action Crimper frame
Die set for MC 3 solar connector (Multi-Contact) & 2.5/4/6m <sup>2</sup> (AWG 14/12/10) solar cable.
Die set for MC 4 solar connector (Multi-Contact) & 2.5/4/6m <sup>2</sup> (AWG 14/12/10) solar cable.
Universal solar cable stripper, for 2.5/4/6m <sup>2</sup> (AWG 14/12/10) solar cable
Forged cable cutter (160mm), for copper cable: 25mm <sup>2</sup> flexible
2 Pcs Open-end spanner and unlocking tool (MC4 and MC4 PLUS)
Pro-soft screwdriver 5x75mm
Pro-soft screwdriver #2 x100mm
Zipper carrying bag-280x197x70(mm)/11"x7.8"x2.8"

## 902-215 8 Pc 1000V Insulated Screwdriver & Plier Set



902-215 contents
0.4x2.5x75mm (3")
0.5x3.0x100mm (4")
1.0x5.5x125mm (5")
PH1x80mm (3.1")
PH2x100mm (4")
6.3" Insulated wire stripping plier
6.3" Insulated side cutter
6.3" Insulated long nose plier
Zipper carrying bag

• Case size: 255x172.5x55/10.0x6.8x2.2 (mm/inch)  
• Individual packing: Inner box & Color label shrink

## 902-218 11 Pc 1000V Insulated Plier & Screwdriver Set



902-218 contents
0.4x2.5x75mm (3")
0.8x4.0x100mm (4")
1.0x5.5x125mm (5")
1.2x6.5x150mm (6")
PH0x60mm (2.4")
PH1x80mm (3.1")
PH2x100mm (4")
7.9" Insulated combination plier
6.3" Insulated side cutter
7.9" Insulated long nose plier
6.3" Insulated long nose plier
Zipper carrying bag

• Case size: 294x240x50/11.6x9.4x2.0 (mm/inch)  
• Individual packing: Inner box & Color label shrink

• NOTE : For quality reason. we reserve the right to change the above specifications without notice.

## 500-026 35 Pc Computer Maintenance Kit

500-026 contents
Fine tip straight tweezer
Side cutter 125mm (4.9")
Long nose plier 138mm (5.4")
Spring hook
6" Adjustable wrench
Quick heat ceramic soldering iron 110V
Desoldering wick
Micro cutting plier 130mm (5.1")
Wire stripper/cutter
PLCC extractor
Field service kit
Mini flash light
7 pcs folding type hex key set (inch)
Blowing brush
IC extractor
Extension blade 7" (175mm)
● Nut blade 1/4", 3/8", 3/16", 5/16", 7/16", 11/32"
● Driver blade T6
● Driver blade T7
● Driver blade T8
● Driver blade T9
Super torque ratchet handle
8 pcs screwdriver blades:
⊕ #0, #1, #2
⊖ 3, 5, 6mm
● T10, T15
Inspection mirror
2 pcs pallets
Empty tool bag

- Case size: 400x300x70mm (15.8"x11.8"x2.8")
- Individual packing: Color box



## 500-017 48 Pc Technician's Tool Kit

500-017 contents
Reverse action tweezer
Fine tip straight tweezer
Brush
7 in 1 crimping tool
IC extractor
PLCC extractor
Screwdriver handle
⊖ Pro-soft s/d 5.0x75mm (3.0")
⊕ Pro-soft s/d #1x75mm (3.0")
● Pro-soft s/d 3/16"(inch)
Wrist strap 10FT
Utility knife (3 blades self loading)
LED Flash light
7 pcs folding type hex key set (inch)
3 prong holder
8" Adjustable wrench
Mini hammer set (including 6 parts)
5 pcs needle file set
Long nose plier 135mm (5.3")
Diagonal cutting plier 110mm (4.3")
Lineman's plier 210mm (8.3")
Flat nose plier 135mm (5.3")
Bent nose plier 130mm (5.1")
6 pcs electronic screwdriver set
Desoldering pump
Quick heat ceramic soldering iron 110V
Solder core 63%, SN
3 pcs soldering aid tools
Heat sink
⊖ / ● Double-end blade 175mm length 4mm/T6
⊕ / ⊕ Double-end blade 175mm length #1/#2
⊖ / ● Double-end blade 175mm length 6mm/T8
⊖ / ● Double-end blade 175mm length T10/T15
Extension blade 175mm (7")
Heavy duty zipper bag

- Case size: 435x325x90mm (17.1"x12.8"x3.5")
- Individual packing: Color box



• NOTE : For quality reason, we reserve the right to change the above specifications without notice.

TWEEZERS

MAGNIFICATION & LIGHTING

FIBER OPTICS

POWER TOOLS

MISCELLANEOUS

INSTRUMENT CASES

LAN/DATACOMM

CONNECTORS

WIRING INSTALLATION

TOOL CASES

TOOL KITS

Index

## ▶ PK-2028T 13 Piece Household Tool Kit

Versatile tool assortment of the most commonly used tools for basic home or office maintenance. Everything you could possibly need for little jobs together in a compact and durable carrying case.



PK-2028T contents
8" Adjustable wrench
LED Flash Light
Long nose plier 160mm (6.3")
All Purpose Snip
Lineman's plier 165mm (6.5")
Screwdriver Probe Voltage Tester
Measuring tape 3M/10FT
Double-End Reversible Screwdriver $\oplus$ #2 / $\ominus$ 6.0x100mm (4.0")
8pcs Aluminum Case Folding Hex Key
9 in 1 Aluminum Handle Precision Screwdriver Set
PVC Insulated Tape
Junior Multi-Purpose Saw
8 oz curved claw Hammer
Plastic Tool Box

- Case size: 320x260x60mm (12.6"x10.2"x2.4")
- Individual packing: Color sleeve shrink



Non-slip handle, stainless steel blade and safety lock



Long Nose Plier  
Made of high quality steel



Magnetic end-hook for convenient measuring

## ▶ PK-2015 13 Pc Deluxe Basic Tool Kit



PK-2015 contents
8" Adjustable wrench
LED Flash Light
Long nose plier 160mm (6.3")
Utility Knife (3 Blades self loading)
Lineman's plier 165mm (6.5")
Screwdriver Probe Voltage Tester
Measuring tape 3M/10FT
Double-End Reversible Screwdriver $\oplus$ #2 / $\ominus$ 6.0x100mm (4.0")
8pcs Aluminum Case Folding Hex Key
9 in 1 Aluminum Handle Precision Screwdriver Set
PVC Insulated Tape
Junior Multi-Purpose Saw
8 oz curved claw Hammer
Pallet for PK-2015 x2
Plastic Tool Box

- Case size: 320x260x60mm (12.6"x10.2"x2.4")
- Individual packing: Color sleeve shrink

• NOTE : For quality reason. we reserve the right to change the above specifications without notice.

# PK-15307EI 54 Pc Electronics Tool Kit



Pro'sKit® upgrade tool kits include new pliers and screwdrivers that provide better performance, and new ceramic soldering iron features energy saving of 60%.



PK-15307EI contents
Long nose plier 135mm (5.3")
Diagonal cutting plier 110mm (4.3")
Dual color lineman's plier 210mm (8.3")
Dual color long nose plier 165mm (6.5")
6" Adjustable wrench
Dual color side cutting plier 165mm (6.5")
5 pcs needle file set
Ceramic Soldering Iron 110V
3-1/2 compact digital multimeter
Measuring tape (3M/10FT)
Solder core 63%, SN
7 pcs hex key set (inch)
Wire stripper cutter
Utility knife (3 blades self loading)
All Purpose Snip
Solder aid tools
Desoldering pump
10 pcs electronic combination wrench (inch)
Flux bottle (2 pcs/pack)
Blow brush (Ø62mm/Ø2.4")
IC extractor
Slip joint plier 154mm (6")
⊖ Pro-soft screwdriver 3.0x75mm (3.0")
⊕ Pro-soft screwdriver #0x75mm (3.0")
⊖ Pro-soft screwdriver 5.0x75mm (3.0")
⊕ Pro-soft screwdriver #1x75mm (3.0")
⊖ Pro-soft screwdriver 6.0x100mm (4.0")
⊕ Pro-soft screwdriver #2x100mm (4.0")
⊕ Pro-soft screwdriver #2x250mm (10")
⊖ Pro-soft screwdriver 6.0x40mm (1.6")
⊕ Pro-soft screwdriver #2x40mm (1.6")
⊖ ProSoft Precision Screwdriver 2.0x50mm (2.0")
⊖ ProSoft Precision Screwdriver 2.4x75mm (3.0")
⊖ ProSoft Precision Screwdriver 3.0x100mm (4.0")
⊕ ProSoft Precision Screwdriver #00x50mm (2.0")
⊕ ProSoft Precision Screwdriver #0x75mm (3.0")
⊕ ProSoft Precision Screwdriver #1x150mm (6.0")
Soldering tip cleaner
Fine tip straight tweezer
Utility component storage box
Hobby vise
2 pcs pallets
Aluminum frame tool case

- Case size (O.D): 458x330x150mm (18"x13"x5.9")
- Individual packing: Color box

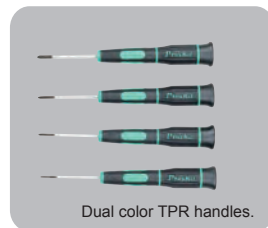

• NOTE : For quality reason. we reserve the right to change the above specifications without notice.

TWEEZERS  
MAGNIFICATION & LIGHTING  
FIBER OPTICS  
POWER TOOLS  
MISCELLANEOUS  
INSTRUMENT CASES  
LAN/DATACOMM  
CONNECTORS  
WIRING INSTALLATION  
TOOL CASES  
TOOL KITS  
Index

# 1PK-1900NA 68 Pc Pro's Electronic Tool Kit

**Upgrade** Pro'sKit® upgrade tool kits include new pliers and screwdrivers that provide better performance, and new ceramic soldering iron features energy saving of 60%.



1PK-1900NA contents
Utility component storage box
Long nose plier 135mm (5.3")
Diagonal cutting plier 110mm (4.3")
Flat nose plier 135mm (5.3")
Bent nose plier 130mm (5.1")
Dual Color Lineman's Plier
Reverse action tweezer
Super drill set w/adaptor 110V
3 pcs soldering aid tools
Soldering iron stand with sponge
6" Adjustable wrench
Ceramic Soldering Iron 110V
Screwdriver handle
● Pro-soft s/d 3/16" (inch)
● Pro-soft s/d 1/4" (inch)
⊖ Pro-soft s/d 3.2x75mm (3.0")
⊕ Pro-soft s/d #0x75mm (3.0")
⊖ Pro-soft s/d 5.0x75mm (3.0")
⊕ Pro-soft s/d #1x75mm (3.0")
⊖ Pro-soft s/d 6.0x57mm (2.2")
⊕ Pro-soft s/d #2x57mm (2.2")
⊕ Pro-soft s/d #2x157mm (6.2")
⊕ Pro-soft s/d #1x150mm (6.0")
⊖ Pro-soft screwdriver 6.0x40mm (1.6")
⊕ Pro-soft screwdriver #2x40mm (1.6")
Brush
Crimping tool (inch)
Desoldering pump
Precision s/d set 6 pcs
5 pcs needle file set
Mini-vacuum cleaner
Cleaning fluid, head (60cc)
Cleaning fluid, head (18cc)
3-1/2 compact digital multimeter
Testing screwdriver
IC extractor
LED Flash light
7 pcs folding type hex key set (inch)
3 prong holder
PVC insulated tape
6" Stainless scissors
Solder core 63%, SN
Bit T10x30mm (1.2")
Bit T15x30mm (1.2")
Wrist strap 10FT
Utility knife (3 blades self loading)
10 pcs electronic combination wrench (inch)
Hobby vise (Jaw opening 40mm/1.6", width 60mm/2.4")
2pcs pallets
Aluminum frame tool case

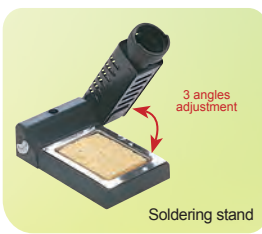

• NOTE : For quality reason. we reserve the right to change the above specifications without notice.

# ▶ 1PK-1700NA 57 Pc Electronics Master Kit



Pro'sKit upgrade tool kits include new pliers and screwdrivers that provide better performance, and new ceramic soldering iron features energy saving of 60%.



1PK-1700NA contents
Utility component storage box
Long nose plier 135mm (5.3")
Diagonal cutting plier 110mm (4.3")
Dual Color Lineman's Plier
Bent nose plier 130mm (5.1")
Side cutting plier 150mm (5.9")
Dual color long nose plier
Reverse action tweezers
3 pcs soldering aid tools
Soldering iron stand with sponge
Adjustable wrench 6"
Ceramic Soldering Iron 110V
⊕ Pro-soft s/d 3/16"(inch)
⊖ Pro-soft s/d 1/4"(inch)
⊕ Pro-soft s/d 3.2x75mm (3.0")
⊖ Pro-soft s/d #0x75mm (3.0")
⊕ Pro-soft s/d 5.0x75mm (3.0")
⊖ Pro-soft s/d #1x75mm (3.0")
⊕ Pro-soft s/d 6.0x100mm (4.0")
⊖ Pro-soft s/d #2x100mm (4.0")
⊕ Pro-soft screwdriver 6.0x40mm (1.6")
⊖ Pro-soft screwdriver #2x40mm (1.6")
Desoldering braid
Brush
6 pcs electronic screwdriver set
Crimping tool (inch)
Desoldering pump
5 pcs needle file set
Testing screwdriver
Alignment tool 2.0mmx200mm (2.0mmx7.9")
IC extractor
Oil can
LED Flash light
7 pcs folding type hex key set (inch)
3 prong holder
6 pcs open-end wrench set
Heavy duty curved-claw hammer
PVC insulated tape
Stainless scissors 6"
Solder core 63%, SN
Parts tube
Heat sink
Utility knife (3 blades self loading)
Measuring tape 3M/10FT
Inspection mirror
Slip-channel pump pliers 254mm (10")
2 pcs pallets
Carrying tool case

- Case size (O.D): 450x325x132mm (17.7"x12.8"x5.2")
- Individual packing: Color box

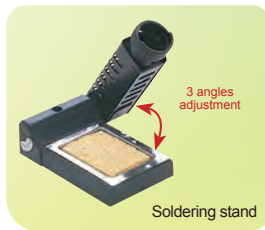

TWEEZERS  
MAGNIFICATION & LIGHTING  
FIBER OPTICS  
POWER TOOLS  
MISCELLANEOUS  
INSTRUMENT CASES  
LAN/DATACOMM  
CONNECTORS  
WIRING INSTALLATION  
TOOL CASES  
TOOL KITS

• NOTE : For quality reason, we reserve the right to change the above specifications without notice.

▶ 1PK-1990A 105 Pc Jumbo Tool Kit



1PK-1990A contents
Utility computer storage box
Flat nose plier 135mm (5.3")
Bent nose plier 130mm (5.1")
Lineman's plier 210mm (8.3")
Side cutting plier 165mm (6.5")
Fine tip straight tweezer
Spring hook
3 pcs soldering aid tools
Desoldering pump
Super drill set w/adaptor 110V or 220V
3 pcs anti-static alignment tool kit
Diagonal cutting nipper
Long nose plier
Long nose plier 165mm (6.5")
Adjustable wrench 6"
Ceramic Soldering Iron 110V
Straight forceps 6"
● Pro-soft s/d 3/16"(inch)
● Pro-soft s/d 1/4"(inch)
⊖ Pro-soft s/d 3.2x75mm (3.0")
⊕ Pro-soft s/d #0x75mm (3.0")
⊖ Pro-soft s/d 5.0x75mm (3.0")
⊕ Pro-soft s/d #1x75mm (3.0")
⊖ Pro-soft s/d 6.0x100mm (4.0")
⊕ Pro-soft s/d #2x100mm (4.0")
⊕ Pro-soft s/d #2x157mm (6.2")
Desoldering wick
Brush
6 pcs electronic screwdriver set
40 pcs socket & screwdriver set
Precision wire stripper
Crimping tool (inch) or (metric)
5 pcs needle file set
IC extractor
Mini flash light
7 pcs folding type hex key set (inch)
3 prong holder
Heavy duty curved-claw hammer
PVC insulated tape
Solder core 63%, SN
Heat sink
Wrist strap 10FT
Measuring tape 3M/10FT
10 pcs electronic combination wrench (inch)
Inspection mirror
Slip joint plier 154mm (6.1")
Pallet for 1PK-1990
Top pallet for 1PK-1990
Aluminum frame tool case



Ceramic heating element, thermal recovery fast.

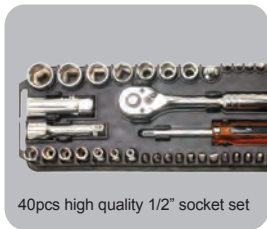

40pcs high quality 1/2" socket set



Made of S45c carbon steel with nickel iron plated.



- Case size (O.D): 461x331x156mm (18.1"x13"x6.1")
- Individual packing: Color box

• NOTE : For quality reason. we reserve the right to change the above specifications without notice.



▶ 500-030 99 Pc Service Technician's Tool Kit



500-030 contents
Utility component storage box
Reverse action tweezer
3 pcs anti-static alignment tool kit
Micro cutting plier
Long nose plier
Diagonal cutting nipper
Long nose plier
Long nose plier 165mm (6.5")
Cabling splicing knife
4" Adjustable wrench
8" Adjustable wrench
Solder aid tool
Quick heat ceramic soldering iron 110V
DMM with mechanical mistake prevention operation
⊖ Line color screwdriver 3.2x75mm (3.0")
⊕ Line color screwdriver #0x75mm (3.0")
⊖ Line color screwdriver 5.0x75mm (3.0")
⊕ Line color screwdriver #1x75mm (3.0")
⊖ Line color screwdriver 3.2x100mm (4.0")
⊖ Line color screwdriver 6.0x100mm (4.0")
⊕ Line color screwdriver #2x100mm (4.0")
⊖ Line color screwdriver 3.2x200mm (8.0")
⊖ Line color screwdriver 6.0x38mm (1.5")
⊕ Line color screwdriver #2x38mm (1.5")
⊖ Line color screwdriver 8.0x150mm (6.0")
Brush
6 pcs electronic screwdriver set
Snap ring plier set
Precision wire stripper
Multi-purpose crimping tool (inch)
23 pcs 1/4" socket set
Oil can
Mini flash light
7 pcs folding type hex key set (inch)
Center punch tool
Feeler gauge
Ball peen hammer with fiberglass handle
Spring hook
Spring hook
6" Steel ruler
3 pcs soldering aid tools
Super torque ratchet handle
4 pcs hex driver blades: 1/16", 5/64", 3/32", 1/8"
7 pcs nut driver blades:
1/4", 3/8", 3/16", 5/16", 7/16", 11/32", 1/2"
⊖ Double ended screwdriver 3mm/#0
Electrician's scissors
10 pcs electronic combination wrench (inch)
Inspection mirror
Slip-channel pump pliers 254mm (10")
ABS tool carrying case with second pallet

- Case size (O.D): 463x331x171mm (18.2"x13.0"x6.7")
- Individual packing: Color box



Frequency/  
Capacitance/  
Temperature/  
DMM all in 1

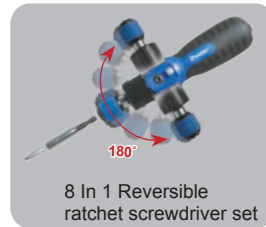

8 In 1 Reversible  
ratchet screwdriver set



Ceramic heating  
element, thermal  
recovery fast.



Precision wire stripping  
and gripping.



• NOTE : For quality reason, we reserve the right to change the above specifications without notice.

TWEEZERS  
MAGNIFICATION & LIGHTING  
FIBER OPTICS  
POWER TOOLS  
MISCELLANEOUS  
INSTRUMENT CASES  
LAN/DATACOMM  
CONNECTORS  
WIRING INSTALLATION  
TOOL CASES  
TOOL KITS  
Index

**PK-4027AI 43 Pc Master Electrical Tool Kit**



PK-4027AI contents
Utility knife (3 blades self loading)
Electrician's scissors
LED flash light
8" Adjustable wrench
PVC insulated tape
Contact voltage tester
Lineman's plier
Side cutting plier
Long nose plier 165mm (6.5")
Quick heat ceramic soldering iron 110V
6" Slip joint plier
8" Slip-channel pump plier
Pen solder 63%
⊖ Pro-soft screwdriver 3.0x75mm (3.0")
⊕ Pro-soft screwdriver #0x75mm (3.0")
⊖ Pro-soft screwdriver 5x75mm (3.0")
⊕ Pro-soft screwdriver #1x75mm (3.0")
⊖ Pro-soft screwdriver 6x100mm (4.0")
⊕ Pro-soft screwdriver #2x100mm (4.0")
⊕ Pro-soft screwdriver #2x200mm (8.0")
Heavy duty wire strippers/crimpers 206mm (8.1")
Measuring tape (5m/16ft)
9pcs ball point long arm hex key set: 1/16", 5/64", 3/32", 1/8", 5/32", 3/16", 1/4", 5/16", 3/8"
Flex head gear wrench: 5/16", 3/8", 7/16", 1/2", 9/16", 5/8", 3/4"
3-3/4 autorange digital multimeter
Ball peen hammer with fiberglass handle
Utility component storage box
Plastic pipe cutter Ø6mm~25mm (Ø0.24"~1.4")
All purpose snip
Aluminum frame tool case w/2 pallets

- Case size (O.D): 486x325x159mm (19.1"x12.8"x6.3")
- Individual packing: Color box



• NOTE : For quality reason. we reserve the right to change the above specifications without notice.

# PK-15308EM 97 Pc Field and Maintenance Service Kit



Pro'sKit® upgrade tool kits include new pliers and screwdrivers that provide better performance, and new ceramic soldering iron features energy saving of 60%.



PK-15308EM contents
3-3/4 autorange digital multimeter
23 pcs 1/4" driver socket set
Heavy duty curved-claw hammer W/fiberglass handle
8" Adjustable wrench
IC extractor
Hobby vise
Slip-channel pump pliers 254mm (10")
⊖ ProSoft Precision Screwdriver 2.0x50mm (2.0")
⊖ ProSoft Precision Screwdriver 2.4x75mm (3.0")
⊖ ProSoft Precision Screwdriver 3.0x100mm (4.0")
⊕ ProSoft Precision Screwdriver #00x50mm (2.0")
⊕ ProSoft Precision Screwdriver #0x75mm (3.0")
⊕ ProSoft Precision Screwdriver #1x150mm (6.0")
Wire Stripper Cutter
⊖ Pro-Soft Screwdriver 5.0x75mm (3.0")
⊕ Pro-Soft Screwdriver #1x75mm (3.0")
⊕ Pro-Soft Screwdriver 5.0X100mm (4.0")
⊕ Pro-Soft Screwdriver #1x100mm (4.0")
⊖ Pro-Soft Screwdriver 6.0X100mm (4.0")
⊕ Pro-Soft Screwdriver #2X100mm (4.0")
⊕ Pro-Soft Screwdriver 6.0x40mm (1.6")
⊕ Pro-Soft Screwdriver #2x250mm (9.8")
⊕ Pro-soft screwdriver #2x40mm (1.6")
Fine tip straight tweezer
Utility component storage box
Long nose plier 135mm (5.3")
Diagonal cutting plier 110mm (4.3")
Lineman's plier 165mm (6.5")
Dual color cutting plier
Dual color long nose plier
9 pcs ball point long arm hex key set
10 pcs electronic combination wrench (inch)
5 pcs needle file set
Ceramic Soldering Iron 110V
Desoldering wick
Solder core 63%, SN
PVC insulated tape
Utility knife (3 blades self loading)
Measuring tape 3M/10FT
All Purpose Snip
Desoldering pump
Flux bottle (2 pcs/pack)
Blow brush (Ø62mm/Ø2.4")
Telescopic magnetic pick up tool
Inspection mirror
1pc Pallet
Heavy-duty ABS cases with wheels and telescoping handle

- Case size (O.D): 465x335x190mm (18.3"x13.2"x7.5")
- Individual packing: Color box
- Not designed to be checked as airline baggage.

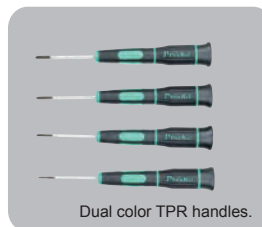

• NOTE : For quality reason, we reserve the right to change the above specifications without notice.

TWEEZERS  
MAGNIFICATION & LIGHTING  
FIBER OPTICS  
POWER TOOLS  
MISCELLANEOUS  
INSTRUMENT CASES  
LAN/DATACOMM  
CONNECTORS  
WIRING INSTALLATION  
TOOL CASES  
TOOL KITS  
Index

## 500-006 Network Maintenance Kit



500-006 contents
Diagonal cutting nipper
Long nose plier
6" Adjustable wrench
Quick heat ceramic soldering iron 110V
6" Straight forceps
For crimping coax connectors
Rotary coaxial cable stripper
● Pro-soft s/d 3/16"(inch)
● Pro-soft s/d 1/4"(inch)
● Pro-soft s/d T10
● Pro-soft s/d T15
● Pro-soft s/d T20
⊖ Pro-soft s/d 3.2x75mm (3.0")
⊕ Pro-soft s/d #0x75mm (3.0")
⊖ Pro-soft s/d 5.0x75mm (3.0")
⊕ Pro-soft s/d #1x75mm (3.0")
⊖ Pro-soft s/d 6.0x100mm (4.0")
⊕ Pro-soft s/d #2x100mm (4.0")
Precision wire stripper
Desoldering pump
Pro-crimper modular tool
IC extractor
Mini flash light
7 pcs folding type hex key set (inch)
Inspection mirror
Zipper carrying bag

- Case size: 375x250x60mm (14.8"x9.8"x2.4")
- Individual packing: Inner box & Color label shrink

## 902-241 Cable Service Kit

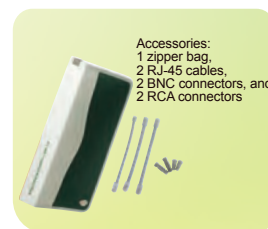

Accessories:  
1 zipper bag,  
2 RJ-45 cables,  
2 BNC connectors, and  
2 RCA connectors



Copper cabling detecting



10 Base-T or 10/100 Base-T datacom networks



Locates and isolates cables quickly and easily

902-241 contents
All-in-one toner & probe kit
Pro-crimper modular tool
Punch down tool with 110/88 and 66 double end blade
Universal stripping tool (UTP/STP, RG-59/6/7/11)
6-in-1 magnetic quick change screwdriver
All purpose snip
Carring zipper case

- Bag size: 333x210x50mm(O.D.)
- Individual packing: Inner box & Color label shrink

• NOTE : For quality reason. we reserve the right to change the above specifications without notice.

## 500-001 Coaxial Crimping Tool Kit



500-001 contents

Crimping tool

Rotary coaxial cable stripper

Round cable cutter

Screwdriver #1x125

DIES:

.255", .213", .187", .068" (Hex)  
 .319", .256", .213", .068" (Hex)  
 .043" (SQ), .100", .213", .068", .137", .255" (Hex)  
 .042" (SQ), .078", .151", .068", .128", .178" (Hex)  
 .10", .128", .429" (Hex)

Carrying case

- Case size: 305x210x58mm (12.0"x8.3"x2.3")
- Individual packing: Color label shrink



## 500-031 Professional Twisted Pair Installer Kit



500-031 contents

RJ-45 die set

RJ-11 die set

RJ-11 DEC die set

AMP RJ-45 die set

RJ-22 die set

Supercrimp crimp tool frame

Punch down tool with 110/66 blades

Multi-function wire strippers

6-position 4 contact flat stranded (50 pcs/bag)

8-position 8 contact round stranded (25 pcs/bag)

Blowing case

- Case size: 340x250x65mm (13.4"x9.8"x2.6")
- Individual packing: Color label shrink



## 500-021 Category 5e/6 Termination Kit

500-021 contents

Multi-network cable tester

Punch down tool with 110/66 blades

Modular crimping tool

UTP/STP cable stripper

4-position 4 contact flat stranded (50 pcs/bag)

8-position 8 contact round stranded (25 pcs/bag)

RJ-45 protection cap. (20 pcs/bag)

Zipper carrying bag

- Case size: 280x197x70mm (11.0"x7.8"x2.8")
- Individual packing: Inner box & Color label shrink



• NOTE : For quality reason, we reserve the right to change the above specifications without notice.

▶ **500-018 Master Network Installation Kit**

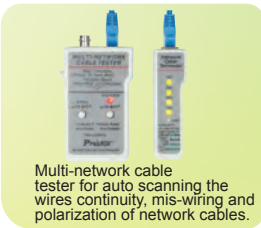

500-018 contents
RJ-45 die set
RJ-11 die set
RG-58, RG-59/62, BNC/TNC die set
Supercrimp crimp tool frame
Multi-network cable tester
Round cable cutter
Rotary coaxial stripper
Precision wire stripper
Punch down tool with 110/66 blades
Mini flash light
7 pcs folding type hex key set (inch)
Extension blade 7" (175mm)
● Nut blade: 1/4", 3/8", 3/16", 7/16", 11/32", 5/16" (inch)
● Driver blade T6
● Driver blade T7
● Driver blade T8
● Driver blade T9
Super torque ratchet handle
8 pcs screwdriver blades: ● #0, #1, #2 ● 3, 5, 6mm ● T10, T15
Inspection mirror
Zipper carrying bag

- Case size: 340x222.5x60mm (13.4"x8.8"x2.4")
- Individual packing: Inner box & Color label shrink

▶ **PK-4302AI PC Networking Tool Kit**



PK-4302AI contents
Dual Color Side Cutting Plier 165mm (6.5")
Dual Color Long Nose Plier 165mm (6.5")
Soldering Iron 30W (110V)
Die Set for RJ45/8P8C
Die Set for RG 58,59,62,6
Die Set for RG 59, 6, F Type
Die Set for Fiber optic connector
Supercrimp Crimp Tool Frame
Wire Stripper Tool
Pen Solder 63%
Pro-Soft Screwdriver ● 3/16"(inch)
Pro-Soft Screwdriver ● 1/4"(inch)
Pro-Soft Screwdriver ● 3.0x75mm (3.0x3.0")
Pro-Soft Screwdriver ● #0x75mm (#0x3.0")
Pro-Soft Screwdriver ● 5.0x100mm (5.0x4.0")
Pro-Soft Screwdriver ● #1x100mm (#1x4.0")
Pouch Down Tool with 110 Blades
Ball Peen Hammer
Wire Stripping Tool for 0.5, 1.2,1.6,2.0mm
Utility Knife (3 Blades Self Loading)
Measuring Tape (3M/10FT)
Desoldering Pump
7 pcs Folding Type Hex Key Set (inch)
3 1/2 Compact Digital Multimeter
Multi-Modular Cable Tester
Utility Component Storage Box
All Purpose Snip
Aluminum Frame Tool Case W/1 Pallet

- Case size: 458x330x150mm (18.0"x13.0"x5.9")
- Individual packing: Color box

• NOTE : For quality reason. we reserve the right to change the above specifications without notice.

## 500-020 Master Network Installation Tool Kit

500-020 contents
Network cable tester (patch cord not included)
Side cutter 125mm (4.92")
Long nose plier 138mm (5.43")
RJ-45 die set
RJ-11 die set
RG-58, RG-59/62, BNC/TNC die set
RJ-22 die set
RG-58, RG-59/62 AU BNC/TNC die set
Supercrimp crimp tool frame
Desoldering pump
Quick heat ceramic soldering iron 110V
6" Curved forceps
Multi-network cable tester
Round cable cutter
Rotary coaxial stripper
Desoldering braid
Precision wire stripper
Punch down tool with 110/66 blades
Mini flash light
7 pcs folding type hex key set (inch)
Blowing brush
Extension blade 7" (175mm)
Nut blade: 1/4", 3/8", 3/16", 7/16", 11/32", 5/16"
Super torque ratchet handle
8 pcs screwdriver blades: #0, #1, #2 3, 5, 6mm T10, T15
Driver blade T6
Driver blade T7
Driver blade T8
Driver blade T9
Wrist strap 10FT
Inspection mirror
3-3/4 autorange digital multimeter
2pcs pallets
ABS tool carrying case w/1 pallet

- Case size: 435x310x145mm (17.1"x12.2"x5.7")
- Individual packing: Color box



3-3/4 Auto range DMM, special with frequency, capacitance, temperature measurement.



8 In 1 Reversible ratchet screwdriver set with storage chamber in handle.



Multi-network cable tester for auto scanning the wires continuity, mis-wiring and polarization of network cables.

## 500-027 Master Network Installation Tool Kit

500-027 contents
Network cable tester(patch cord not included)
Side cutter 125mm (4.92")
Long nose plier 138mm (5.43")
RJ-45 die set
RJ-11 die set
AMP RJ-45 die set
RG-58, RG-59/62, BNC/TNC die set
Supercrimp crimp tool frame
Multi-network cable tester
Round cable cutter
Rotary coaxial stripper
Wire stripper
Precision wire stripper
Punch down tool with 110/66 blades
7 pcs folding type hex key set (inch)
A roll of Cat.5 STP24x4P (7/0.2) length: 10M
A roll of Cat.5 UTP24x4P (7/0.2) length: 10M
1pc pallet
ABS tool carrying case w/1 pallet

- Case size: 435x310x145mm (17.13"x12.2"x5.7")
- Individual packing: Color box



Pro-Crimper Ratcheting Crimper features 40-50% force saving.

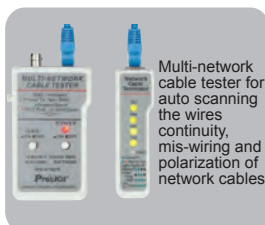

Multi-network cable tester for auto scanning the wires continuity, mis-wiring and polarization of network cables.



Ergonomic punch down tool increased HI/LOW forces.



• NOTE : For quality reason, we reserve the right to change the above specifications without notice.

## PK-2016 Telecom Maintenance Belt Kit



Ideal for installing, maintaining, and troubleshooting voice network. The handy pouch includes essential telecom tools, built for communication installers, telecom installers, and telephone linesmen In this handy belt kit.

PK-2016 contents
Data diver
Punch down tool with 110/88 and 66 double end blade
Cable splicing knife
Electrician scissors
Tone probe kit
Soft side tool pouch

- Bag size: 305x235x95mm (12"x9.3"x3.7")
- Individual packing: Color box



The telecom test set with LCD display, features line polarity test, and line service.

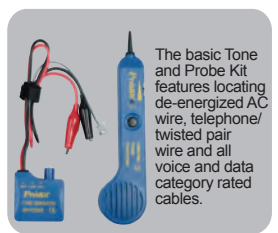

The basic Tone and Probe Kit features locating de-energized AC wire, telephone/ twisted pair wire and all voice and data category rated cables.

## PK-4022EI Deluxe Telecom Installer's Kit



Ideal for installing, maintaining, and troubleshooting voice networks. A convenient way for carrying tools inside the PVC handbag provides handy and compact usage to installers. PK-4022EI is a good choice for communication installers, telecom installers, and telephone linesmen.

PK-4022EI contents
Data Diver
6" straight forceps
Electrician's knife
5" cutting plier
5.5" long nose plier
6" long nose plier 170mm (6.7")
Probe-pic spudger
Electrician scissors
Double-end screwdriver
⊕ Pro-soft screwdriver #1x75mm (3.0")
⊕ Pro-soft screwdriver #2 6x100mm (4.0")
⊖ Pro-soft screwdriver 8x150mm (6.0")
⊖ Pro-soft screwdriver 6x150mm (6.0")
Precision wire stripper (AWG 30/28/26/24/22/20)
Punch down tool with 110/66 blades
Tone probe kit (battery not include)
In-line modular adapters 4/6/8 pin 3 in 1
8 pcs folding hex key set
Soldering iron 110V
Double end socket can wrench
2 pcs pallets
Deluxe carry bag with 2 pallets

- Case size: 435x325x90mm (17.1"x12.8"x3.5")
- Individual packing: Color box



The telecom test set with LCD display, features line polarity test, and line service.

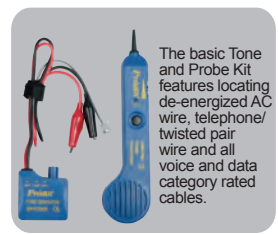

The basic Tone and Probe Kit features locating de-energized AC wire, telephone/ twisted pair wire and all voice and data category rated cables.

• NOTE : For quality reason, we reserve the right to change the above specifications without notice.



## PK-12012H Telecom Installation Kit

PK-12012H contents
Dual color long nose plier 136mm (5.4")
Dual color diagonal cutting plier 125mm (4.9")
Professional modular plug tool crimps strips & cuts
Punch down tool 110 blade and 66 blade
Multi-modular cable tester
Butt set
⊖ pro-soft screwdriver 5x75mm (3.0")
⊖ pro-soft screwdriver 6x100mm (4.0")
⊕ pro-soft screwdriver #2x100mm (4.0")
⊕ pro-soft screwdriver #2x40mm (1.6")
Soft side tool pouch

- Case size: 305x235x95mm (12"x9.3"x3.7")
- Individual packing: Color box



Dual purpose belt for easy carrying on shoulder or waist



For 4P/6P/8P modular plug better crimping in parallel action.

Pro'sKit® upgrade tool kits include new pliers and screwdrivers that provide better performance and long service life.



## 500-043 Communication Maintenance Kit

500-043 contents
Reverse action tweezer
Spring hook
3 pcs anti-static alignment tool kit
Micro cutting plier
Diagonal cutting nipper
Long nose plier
Long nose plier 165mm (6.5")
6" Adjustable wrench
Probe-pic spudger
5" Straight forceps
Tone probe kit
Replacement blade-110
6 pcs electronic screwdriver set
Precision wire stripper
Insertion/extraction tool
Mini flash light
7 pcs folding type hex key set (inch)
Impact & punch down tool w/o blade
6" Steel ruler
Extension blade 7" (175mm)
Super torque ratchet handle
8 pcs screwdriver blades: ⊕ #0, #1, #2   ⊖ 3, 5, 6mm   ⊕ T10, T15
7 pcs nut driver blades: ⊕ 1/4", 3/8", 3/16", 5/16", 7/16", 11/32", 1/2" (inch)
Double ended screwdriver ⊖ 3mm/ ⊕ #0
Wrist strap 10FT
Measuring tape 3M/10FT
Electrician's scissors
Inspection mirror
Butt set
Dual telephone line tester
Electrician's knife
Slip-channel pump pliers 204mm (8.03")
2 pallets
Deluxe carrying bag

- Case size: 435x325x90mm (17.1"x12.8"x3.5")
- Individual packing: Plain box + Color label



The heavy duty butt set complies with weatherproofing allowing use in toughest environments, features high impedance monitor for data safe operation



The basic Tone and Probe Kit features locating de-energized AC wire, telephone/twisted pair wire and all voice and data category rated cables

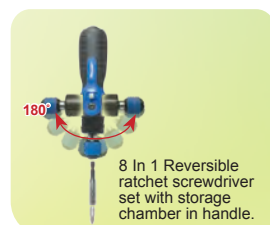

8 In 1 Reversible ratchet screwdriver set with storage chamber in handle.

• NOTE : For quality reason, we reserve the right to change the above specifications without notice.

**PK-14019A Communication Maintenance Kit**

 **Pro'sKit** upgrade tool kits include new pliers and screwdrivers that provide better performance and long service life.



PK-14019A contents
Long nose plier 135mm (5.3")
Diagonal cutting plier 115mm (4.5")
Dual color side cutting plier 165mm (6.5")
Dual color long nose plier 165mm (6.5")
Adjustable wrench 6"
3 3/4 Autorange digital multimeter
Tone probe kit
7 pcs hex key set (inch) or (metric)
Punch down tool 110 blade
All Purpose Snip
Butt set
In-line modular adapters 4/6/8 pin 3 in 1
Electrician's knife
⊖ Pro-soft screwdriver 3.0 x75mm (3.0")
⊕ Pro-soft screwdriver #0 x75mm (3.0")
⊖ Pro-soft screwdriver 6.0 x100mm (4.0")
⊕ Pro-soft screwdriver #2 x100mm (4.0")
⊖ Pro-soft screwdriver 5.0 x100mm (4.0")
⊕ Pro-soft screwdriver #1 x100mm (4.0")
⊖ Pro-soft screwdriver 3/16" (inch) or 5mm (metric)
⊕ Pro-soft screwdriver 1/4" (inch) or 6mm (metric)
Deluxe aluminum frame tool case
• Case size(O.D): 440x340x165mm (17.3"x13.4"x6.5")
• Individual packing: Plain box + Color label





# 902-242 Deluxe Telecom Installation Kit



902-242 contents
All purpose snip
Double end socket can wrench
8 pcs folding hex key set
Electrician's knife
6" Long nose plier black oxide finish
Dual color diagonal cutting plier (110mm/4.33")
Micro cutting plier
6" Adjustable wrench
Probe-pic spudder
Electrician's scissors
⊖ Pro-soft screwdriver 6.0x100mm (4.0")
⊕ Pro-soft screwdriver #2x100mm (4.0")
⊖ Pro-soft screwdriver 5.0x100mm (4.0")
⊕ Pro-soft screwdriver #1x100mm (4.0")
Double-end screwdriver
Precision hand drill
23 pcs 1/4" driver socket set
All-in-one toner & probe kit
In-line modular adapters 4/6/8 pin 3 in 1
Punch down tool with 110/66 blades
Heavy duty curved-claw hammer W/Fiberglass handle
Fish tape (50FT)
Velcro cable tie-5" assortment (15 pcs/pack)
10 pcs electronic combination wrench (Inch)
Utility component storage box
Pro-crimper (frame only)
Die set for 902-085 8P8C/RJ45 plug & cable O/D around 5.2ø
Die set for 902-085 RG 58, 59, 62, 174
Die set for 902-085 CATV F connectors RG 59, 6
Hi-reliability tape measure 3M/10Ft
6" straight forceps
2 pallets
Aluminum frame tool case with second pallet

- Case size: 461x331x156mm (18.2"x13"x6.1")
- Individual packing: Color box



Interchangeable Ratcheting Crimper, force saving up to 30%



23 pcs 1/4" driver socket set



Ergonomic punch down tool increased HI/LOW forces.



VDV Tester (Voice/Data/Video)



• NOTE : For quality reason. we reserve the right to change the above specifications without notice.

TWEEZERS  
MAGNIFICATION & LIGHTING  
FIBER OPTICS  
POWER TOOLS  
MISCELLANEOUS  
INSTRUMENT CASES  
LAN/DATACOMM  
CONNECTORS  
WIRING INSTALLATION  
TOOL CASES  
TOOL KITS  
Index

**PK-4023EI Master Telecom Installation and Service Kit**



Designed specially for telecom installers, network and cable television engineers. A convenient way for carrying tools inside the rugged ABS tool case provides convenience to installers.

PK-4023EI contents
Desoldering wick with 2.0mm
Blowing brush
Rotary Coaxial Stripper
2 pallets
7" Extension blade (175mm)
Driver blade T6
Driver blade T7
Driver blade T8
Driver blade T9
8 pcs screwdriver blades ⊕ #0, #1, #2   ⊖ 3, 5, 6mm   ⊕ T10, T15
Wrist strap 10FT
● Nut blade: 1/4", 3/8", 3/16", 7/16", 11/32", 5/16"(inch)
Super torque ratchet handle
5" cutting pliers
5.5" long nose pliers
8" lineman's pliers (215mm/8.46") black oxide finish
Professional 3 3/4 auto-ranging digital multimeter
All purpose snip
6" Adjustable wrench
8.7" fiber optic crimping tool
8 pcs folding hex key set
10" Adjustable wrenches
Double end socket can wrench
Utility knife(3 blades self loading)
Punch down tool with 110/66 blades
4P/6P/8P Telecom crimping tool
Testing screwdriver
Utility component storage box
Soldering iron 110V
Precision wire stripper (AWG22/20/18/16/14/12/10)
All-in-one toner & probe kit
Data diver
Tool case W/1 pallet



- Case size (O.D): 463x331x171mm (18.2"x13.0"x6.7")
- Individual packing: Color box

# PK-4028AI Telecom & Networking Installation Tool Kit



PK-4028AI contents
5 PCS Needle File Set
Pro-Crimper (Frame only)
Die Set, RJ11
Die Set, RJ45 modular plugs 8 position(Standard plugs,not AMP)
Punch down tool (with 110 blades)
Replacement Blade for CP-3140 with 66 Type
Die Set for CP-372T CATV F Connectors RG 59,6
Die Set for CP-372S RG 58,59,62,6
Utility Knife(3 Blades Self Loading)
Electrician's Scissors
Desoldering Pump
LED Flash Light
6" Adjustable wrenches
PVC Insulated tape
Contact Voltage Tester
8" Combination Plier
6" Side Cutting Plier
6" Long Nose Plier
Quick Heat Ceramic Soldering Iron 110V
8" Groove Joint Plier
⊖ Pro-Soft Screwdriver 5x75mm (3.0")
⊕ Pro-Soft Screwdriver #1x75mm (3.0")
⊖ Pro-Soft Screwdriver 6x100mm (4.0")
⊕ Pro-Soft Screwdriver #2x100mm (4.0")
⊖ Pro-Soft Screwdriver 6x40mm (1.6")
⊕ Pro-Soft Screwdriver #2x40mm (1.6")
Wire Stripper Tool
Measuring Tape (3M/10FT)
9pcs Ball Point Long Arm Hex Key Set: 1/16", 5/64", 3/32", 1/8", 5/32", 3/16", 1/4", 5/16", 3/8"
Cable Sniffer-Remote
In-Line Modular Adapters 4/6/8 Pin 3 In 1
Ball Peen Hammer with Fiberglass Handle
All Purpose Snip
Soft Side Tool Pouch
2 pallets for PK-4028 Series
Aluminum Frame Tool Case W/2 Pallets

- Case size: 486x325x159mm (19.1"x12.8"x6.3")
- Individual packing: Color box

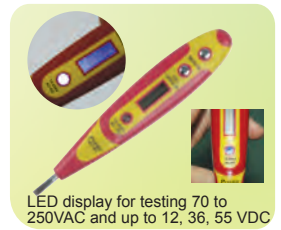

• NOTE : For quality reason. we reserve the right to change the above specifications without notice.

TWEEZERS  
MAGNIFICATION & LIGHTING  
FIBER OPTICS  
POWER TOOLS  
MISCELLANEOUS  
INSTRUMENT CASES  
LAN/DATACOMM  
CONNECTORS  
WIRING INSTALLATION  
TOOL CASES  
TOOL KITS  
Index

# INDEX

Cat.#	Page
<b>1</b>	
100-002	69
100-003	33
100-004	33
100-006	31
100-007	36
100-008	60
100-011	30
100-012	31
100-013	30
100-014	31
100-015	31
100-017	31
100-021	43
100-022	44
100-025	31
100-033	43
100-035	50, 136
100-039	44
100-040	33
100-042	33
100-044	33
100-046	29
100-049	50
<b>1PK</b>	
1PK-125T	116
1PK-1700NA	189
1PK-1900NA	188
1PK-1990A	190
1PK-3003D30	55
1PK-3003D31	55
1PK-3003D32	55
1PK-3003D33	55
1PK-3003D34	55
1PK-3003D7	55
1PK-3003FD27	56
1PK-9402	97
1PK-3179	144
<b>2</b>	
200-002	37
200-003	71
200-004	73
200-005	73
200-006	46
200-007	70
200-007W	70
200-009	70
200-013	45
200-015	45
200-016	72
200-034	46
200-035	46
200-036	70
200-037	33
200-038	43
200-039	44
200-040	36
200-041	36
200-042	70
200-042-100	70
200-043	46
200-045	44
200-046	45
200-047	68, 135
200-048	70
200-050	73

Cat.#	Page
200-051	73
200-053	60
200-056	30
200-057	30
200-058	30
200-059	30
200-060	31
200-063	44
200-064	72
200-065	72
200-067	31
200-068	45
200-069	45
200-070	71
200-071	37
200-072	71
200-080	37
200-081	73
200-082	36
200-083	36
200-084	73
200-085	70
200-087	33
200-088	37
200-090	72
200-091	71
200-092	29
<b>3</b>	
300-001	57
300-002	56
300-003	55
300-004	59
300-004B	59, 60
300-005	56
300-007	55
300-009	57
300-010	57
300-011	63
300-015	64
300-016	64
300-018	60
300-019	55
300-021	56
300-022	55
300-023	55
300-024	56
300-028	60
300-035	63
300-037	60
300-038	55
300-039	56
300-039	56, 58
300-041	55
300-045	55
300-047	56
300-048	55
300-049	55
300-050	56
300-054	54
300-055	65
300-056	54
300-058	56
300-063	59
300-064	59
300-070	56
300-071	56

Cat.#	Page
300-072	56
300-073	56
300-074	61
300-075	63
300-077	57
300-077D	57
300-078	60
300-086	57
300-087	57
300-088	60
300-089	60
300-090	60
300-091	61
300-092	61
300-095	56
300-096	54
300-097	57
300-101	56
300-102	56
300-103	57
300-104	56
300-105	57
300-106	56
300-107	65
300-108	56
300-109	55
300-112	55
300-115	56
300-116	55
300-117	55
300-118	56
300-119	55
300-120	56
300-130	56
300-131	56
300-132	56
300-133	56
300-134	57
300-141	56
300-142	56
300-143	56
300-144	57
300-145	57
300-146	56
300-147	56
300-149	63
300-151	44
300-156	62
300-157	55
300-158	55
300-159	55
300-160	57
300-161	55
300-162	55
300-163	55
300-164	56
300-165	57
300-166	57
300-167	56
300-168	55
300-169	56
300-170	57
300-171	57
300-172	56
300-173	55
300-174	56

Cat.#	Page
300-175	57
300-176	57
300-177	56
300-178	55
300-179	55
300-180	55
300-181	55
300-182	55
300-183	55
300-184	55
300-185	55
300-186	55
300-187	55
300-188	55
300-189	55
300-190	55
300-191	55
300-192	55
300-193	55
300-194	55
300-195	55
3PK-NT018S-ST	134
<b>4</b>	
400-001	12
400-004	12
400-011	8
400-026	11
400-028	7
400-029	25
400-030	25
400-042	6
400-044	140
<b>5</b>	
500-001	195
500-003	182
500-006	194
500-016	183
500-017	185
500-018	196
500-020	197
500-021	195
500-023	137
500-024	92
500-025	181
500-026	185
500-027	197
500-030	191
500-031	195
500-032	183
500-037	63
500-041	92
500-042	182
500-043	199
500-047	182
5CP-16A	76
5CP-376E-B	60
5CP-376K-BLADE	59
5DP-366D-T	83
5DP-366P-T	83
5FB-1688-BLAD	135
5MT-7600-LC	134
<b>5PT</b>	
5PT-0721-ADA	128
5PT-1080-BAT	128
5PT-1080-BAT	128
5PT-1080-CH	128

Cat.#	Page	Cat.#	Page	Cat.#	Page	Cat.#	Page
5PT-1080-P1	127, 128	702-021	167	7KJ3-C3-66WH	158	7PK-317V1-IV	159
5PT-1201-ADA	127	702-022	167	7KJ8-C6USBK-Y	158	7PK-317V1-WH	159
5PT-1201-BAT	127	702-059	167	7KJ8-C6USBL-Y	158	7PK-317V2-IV	159
5PT-1201-CH	127	702-063	167	7KJ8-C6USGN-Y	158	7PK-317V2-WH	159
5PT-1361-ADA	129	702-066	167	7KJ8-C6USGY-Y	158	7PK-317V3-IV	159
5PT-1361-P1	129	702-067	167	7KJ8-C6USIV-Y	158	7PK-317V3-WH	159
5PT-1441-ADA	127	702-079	167	7KJ8-C6USRD-Y	158	7PK-317V4-IV	159
5PT-1441-BAT	127	702-080	167	7KJ8-C6USWH-Y	158	7PK-317V4-WH	159
5PT-1441-CH	127	<b>703</b>		7KJ8-C6USYL-Y	158	7PK-317V6-IV	159
5PT-5721-ADA	130	703-001	167	7KJ8-CEUSBK-Y	158	7PK-317V6-WH	159
5PT-5201A-P	130	703-002	167	7KJ8-CEUSBL-Y	158	7PK-318-IV	160
<b>5S</b>		703-003	167	7KJ8-CEUSGN-Y	158	7PK-318-WH	160
5SI-125T-B	81	703-004	167	7KJ8-CEUSGY-Y	158	7PK-342RC6US-DWH	161
5SI-125T-D	81	703-005	167	7KJ8-CEUSIV-Y	158	7PK-342RC6US-MWH	161
5SI-125T-SB	81	703-006	167	7KJ8-CEUSRD-Y	158	7PK-342RCEUS-DWH	161
5SI-216N-0.8D	80	703-007	167	7KJ8-CEUSWH-Y	158	7PK-342RCEUS-MWH	161
5SI-216N-1.2D	80	703-008	167	7KJ8-CEUSYL-Y	158	<b>7PM</b>	
5SI-216N-1.6D	80	703-009	167	7KJ-P24-M	157	7PMV12T-K11-C6C/BK	156
5SI-216N-1C	80	<b>711</b>		<b>7M</b>		7PMV12T-K11-CEC/BK	156
5SI-216N-2.4D	80	711-AM-1-9	163	7MU5-B-IV	160	<b>800</b>	
5SI-216N-2C	80	711-AS-1-9	163	7MU5-BNC-IV	160	800-001	96
5SI-216N-3.2D	80	711-FM-1-5	163	7MU5-BNC-WH	160	800-002	96
5SI-216N-3C	80	711-FS-1-2	163	7MU5-B-WH	160	800-003	96
5SI-216N-4C	80	711-HM-1-5	164	7MU5-F-IV	160	800-004	96
5SI-216N-B	80	711-HS-1-2	164	7MU5-F-WH	160	800-005	96
5SI-216N-B1.0	80	711-LM-1-1	164	7MU5-ST-IV	160	800-006	96
5SI-216N-BC	80	711-LS-1-1	164	7MU5-ST-WH	160	800-007	94
5SI-216N-I	80	711-MM-1-1	164	<b>7P</b>		800-009	94
5SI-216N-K	80	711-MS-1-1	164	7P-12AK11CEC-BK	154	800-010	96
<b>6</b>		711-PM-1-1	164	7P-12TK11C6C-BK	155	800-011	96
6HP-9060	25	711-PS-1-1	164	7P-12TK11CEC-BK	155	800-012	96
6HP-9100	25	<b>715</b>		7P-24AK11CEC-BK	154	800-013	96
6HP-9150	25	715-01S1-1	165	7P-24TK11C6C-BK	155	800-014	96
6HP-9250	25	715-02S1-1	165	7P-24TK11CEC-BK	155	800-015	96
6S-2	84	715-03M1-3	165	7P-32TK11CEC-BK	155	800-016	96
<b>700</b>		715-03S1-1	165	7P-48AK11CEC-BK	154	800-017	96
700-007	76	715-07S1-1	165	7P-48TK11C6C-BK	155	800-018	96
700-008	76	715-08M1-3	165	7P-48TK11CEC-BK	155	800-019	96
700-009	76	715-08S1-1	165	<b>7PK</b>		800-020	96
700-010	76	715-10M1-3	165	7PK-300-1IV	159	800-021	96
700-011	76	715-10S1-1	165	7PK-300-1WH	159	800-022	96
700-012	76	715-12M1-3	165	7PK-300-2IV	159	800-023	96
700-014	75	715-12S1-1	165	7PK-300-2WH	159	800-024	96
700-015	76	715-15M1-3	165	7PK-300-3IV	159	800-025	96
700-016	75	715-15S1-1	165	7PK-300-3WH	159	800-026	96
700-017	76	<b>74</b>		7PK-300-4IV	159	800-027	96
700-018	75	744-FA03	167	7PK-300-4WH	159	800-028	100
700-020	76	744-FA50	167	7PK-300-6IV	159	800-029	100
700-021	76	<b>76</b>		7PK-300-6WH	159	800-030	96
700-022	76	764-RA03	167	7PK-301AIV	162	800-032	96
700-023	76	764-RX50	167	7PK-301AWH	162	800-033	96
700-024	75	<b>78</b>		7PK-302AIV	162	800-034	96
700-024-25	75	788-FA03	167	7PK-302AWH	162	800-035	96
700-025	75	788-FA50	167	7PK-315A-C6/BK	162	800-036	96
700-025-25	75	788-FX15	167	7PK-315A-C6/WH	162	800-037	96
700-026	76	788-FX50	167	7PK-315A-CE/BK	162	800-038	96
700-027	76	788-RA03	167	7PK-315A-CE/WH	162	800-039	143
700-028	76	788-RA50	167	7PK-315AS-C6	162	800-040	95
700-029	75	788-RX15	167	7PK-315AS-CE	162	800-041	101
700-RA50	167	788-RX50	167	7PK-317H1-WH	159	800-042	101
<b>702</b>		<b>7K</b>		7PK-317H1-IV	159	800-043	96
702-001	167	7KJ15-C6USBL	157	7PK-317H2-IV	159	800-044	96
702-008	167	7KJ15-C6USWH	157	7PK-317H2-WH	159	800-045	96
702-009	167	7KJ15-CEUSBL	157	7PK-317H3-IV	159	800-046	96
702-013	167	7KJ15-CEUSWH	157	7PK-317H3-WH	159	800-047	96
702-018	167	7KJ3-C3-66IV	158	7PK-317ICON	159	800-048	102

TWEETERS  
MAGNIFICATION & LIGHTING  
FIBER OPTICS  
POWER TOOLS  
MISCELLANEOUS  
INSTRUMENT CASES  
LAN/DATACOM  
CONNECTORS  
WIRING INSTALLATION  
TOOL CASES  
TOOL KITS

# INDEX

Cat.#	Page	Cat.#	Page	Cat.#	Page	Cat.#	Page
800-048E	102	900-049	145	900-150	140	<b>902</b>	
800-049	62	900-052	176	900-151	140	902-011	37
800-050	62	900-054	176	900-157	136	902-049	43
800-052	106	900-055	60	900-158	146	902-054	55
800-060	92	900-056	113	900-162A	152	902-062	46
800-066	106	900-057	113	900-162B	152	902-068	125
800-068	103	900-058	145	900-162C	152	902-068B	125
800-070	143	900-061	121	900-164A	152	902-069	103
800-072	62	900-061-3X	121	900-164B	152	902-070	144
800-073	92	900-061B	121	900-167	125	902-071	117
800-074	101	900-061-CLAMP	121	900-169	49	902-072	116
800-076	103	900-063	122	900-169B	49	902-073	144
800-077	94	900-064	122	900-176	136	902-075	37
800-078	103	900-065	64	900-177	146	902-076	37
800-079	62	900-066N	81	900-179	145	902-077	37
800-080	101	900-067	109	900-181	145	902-078	34
800-081	104	900-068	109	900-182	125	902-079	34
800-091	106	900-069	109	900-194	110	902-082	50
800-092	95	900-070	109	900-199	175	902-083	50
800-092-50	95	900-071	116	900-203	175	902-084	50
800-114	88	900-072	116	900-204	116	902-085	53
800-115	88	900-073N	81	900-205	144	902-086	59
800-116	88	900-074N	81	900-206	83	902-087	61
800-117	88	900-075	122	900-212	143	902-088	69
800-118	88	900-075A	122	900-215	48	902-090	68
800-119	88	900-076	122	900-216	140	902-094	83
800-120	88	900-077	122	900-217	109	902-095	84
800-121	88	900-078	59	900-219	136	902-096	100
800-122	88	900-079	122	900-222	145	902-097	100
800-123	96	900-080	122	900-225	176	902-099	99
800-124	106	900-080B	122	900-229	49	902-100	106
800-129	89	900-081	122	900-230	146	902-101	107
800-130	88	900-082	122	900-235	122	902-108	124
800-148	101	900-091A	151	900-236	122	902-109	121
800-149	94	900-094	142	900-238	142	902-110	121
800-150	94	900-096	122	900-239	125	902-112	151
<b>8PK</b>		900-099	84	900-242	84	902-113	151
8PK-2066	97	900-100	84	900-243	84	902-114	151
8PK-6182	95	900-103	143	900-244	6	902-116	145
8PK-SD010	101	900-112	49	900-245	81	902-117	145
<b>900</b>		900-112B	49	900-246	178	902-117-JAWS	145
900-002	113	900-113	49	900-247	141	902-118	177
900-004	82	900-113B	49	900-248	141	902-119	177
900-008	82	900-114	113	900-249	141	902-121	181
900-011	175	900-115	82	900-250	84	902-132	81
900-012	113	900-116	113	900-251	146	902-133	81
900-015	83	900-117	60,72	900-252	146	902-134	81
900-016	84	900-118A	82	900-253	146	902-135	81
900-018N	81	900-123	123	900-254	146	902-137	55
900-019	140	900-124	123	900-255	143	902-138	56
900-020N	81	900-125	122	900-257	49	902-139	55
900-022	113	900-125B	122	900-257B	49	902-143	55
900-023	113	900-126	122	900-258	142	902-145	56
900-026	73	900-132	113	900-259	81	902-146	55
900-027	73	900-133	113	900-260	177	902-147	55
900-032	142	900-135	49	900-262	173	902-148	56
900-035	81	900-137	136	900-263	117	902-152	56
900-036	81	900-138	136	900-264	117	902-158	56
900-037	83	900-140	75	900-265	117	902-159	56
900-038	107	900-141	174	900-266	117	902-160	57
900-039	151	900-142	122	900-267	117	902-161	56
900-040	151	900-146	81	900-268	117	902-162	57
900-041	151	900-147	169	900-269	117	902-166	56
900-043	151	900-147A	122	900-270	146	902-167	56
900-045	174, 175	900-148	169	900-271	141	902-168	57
900-048	174	900-149	169	900-272	141	902-169	56



Cat.#	Page	Cat.#	Page	Cat.#	Page	Cat.#	Page
902-171	55	902-323	73	CP-3006FD2	58	MA-020	123
902-172	55	902-324	73	CP-3006FD36	58	MA-021	123
902-174	81	902-325	73	CP-3006FS1	58	MA-022	123
902-186N	135	902-326	73	CP-3006FS2	58	MA-1205CA-B	121
902-189	49	902-329	81	CP-301G	68	MA-1209LA	120
902-197	169	902-330	56	CP-302G	68	MA-1503A	120
902-201	55	902-331	56	CP-313	62	<b>MS</b>	
902-202	40	902-332	56	CP-3145A	75	MS-3207	62
902-203	40	902-333	81	CP-3147	76	MS-322	143
902-204	40	902-334	73	CP-3148	76	MS-525	139
902-205	40	902-334-BLADES	73	CP-315	62	MS-526	139
902-206	40	902-335	84	CP-3150	76	<b>MT</b>	
902-207	40	902-337	57	CP-336FD27	56	MT-1132	17
902-208	40	902-394	139	CP-351B	65	MT-1210	18
902-209	98	902-395	139	CP-367A	71	MT-1217	16
902-210	98	902-396	139	CP-372FD27	56	MT-1232	17
902-211	98	902-397	139	CP-376K	59	MT-1233C	18
902-212	98	902-398	139	CP-376M	59	MT-1233D	18
902-213	98	902-459	7	CP-382	171	MT-1270	16
902-214	98	902-462	117	CP-383	171	MT-1280	16
902-215	99,184	902-463	117	CP-385	171	MT-1630	17
902-216	98	<b>9B</b>		CP-391	170	MT-1705	15
902-217	98	9BX-3018B	150	CP-391-1	170	MT-1710	14
902-218	99,184	<b>9C</b>		CP-391-2	170	MT-1820	14
902-219	93	9CP-336DF4	56	CP-392	170	MT-1860	14
902-220	98	<b>9D</b>		CP-392-3	170	MT-2017	20
902-221	124	9DK-2053A-B	169	CP-392-4	170	MT-2018	20
902-222	92	<b>9PK</b>		CP-392-5	170	MT-3102	19
902-224	142	9PK-3003D26	57	CP-412G	69	MT-3105	20
902-226	106	9PK-3003D27	56	CP-413G	69	MT-3109	19
902-227	83	9PK-3003D29	55	CP-415	69	MT-3266	19
902-228	8	9PK-3003D36	56,58	CP-416	64	MT-4011	21
902-229	72	9PK-3003D42	56	CP-462G	64	MT-4017	21
902-230	50	<b>9PT</b>		CP-463	64	MT-4018	21
902-238	123	9PT-5201-P2	130	CP-511A	70	MT-5110	15
902-239	123	9PT-5721-P2	130	CP-522	72	MT-5210	15
902-240	124	<b>9S</b>		CP-5S1D	57,58	MT-7025	9
902-241	194	9SS-900-A1	78	CP-5S2D	57,58	MT-7057	11
902-242	201	9SS-900-A2	78	CP-808	61	MT-7058	10
902-245	62	9SS-900-A3	78	CP-FB01	135	MT-7059	9
902-246	43	9SS-900-B	78	<b>D</b>		MT-7062	10
902-247	69	9SS-900-C	78	DK-2053A	169	MT-7509	135
902-255	144	9SS-900-D	78	DK-2112	48	MT-7600	134
902-256	144	9SS-900-E	78	DP-336D	82	MT-8006B	7
902-257	144	9SS-900-F	78	DP-366P	82	MT-8100	5
902-258	46	9SS-900-H	78	<b>F</b>		MT-9906	25
902-259	46	9SS-900-I	78	FB-1688	135	MT-9907	25
902-260	136	9SS-900-J	78	FL-516	125	MTB-1	178
902-265	62	9SS-900-K	78	FL-603	125	<b>NT</b>	
902-267	7	9SS-900-L	78	<b>G</b>		NT-306	24
902-268	72	9SS-900-M	78	GK-368	83	NT-311	24
902-269	72	9SS-900-N	78	GK-67330-8	83	NT-312	24
902-270	61	9SS-900-O	78	GS-200K	82	NT-3200	12
902-275	57	9SS-969-A1	79	GS-210	82	NT-6352	24
902-276	57	9SS-969-A2	79	GS-520	82	NT-6540	22
902-277	55	9SS-969-A3	79	<b>H</b>		NT-6556	21
902-278	55	9ST-902	179	HW-229B	107	NT-6560	22
902-279	55	<b>B</b>		HW-312B	109	NT-6570	23
902-307	43	Bulb-T4	124	HW-312S	109	NT-6580	23
902-311	178	Bulb-T5	121	HW-5912E	109	<b>PD</b>	
902-312	179	<b>C</b>		HW-6509B	109	PD-155	140
902-314	178	CE-0275	139	HW-6514B	109	PD-372	145
902-317	48	CP-246	71	HW-928	106	PD-395A	49
902-318	48	CP-251B	65	<b>MA</b>		PD-998	48
902-319	48	CP-3005F	55	MA-016	122	<b>PK</b>	
902-321	171	CP-3006F	53	MA-019	123	PK-12012H	199

TWEETERS  
MAGNIFICATION & LIGHTING  
FIBER OPTICS  
POWERTOOLS  
MISCELLANEOUS  
INSTRUMENT CASES  
LAN/DATACOMM  
CONNECTORS  
WIRING INSTALLATION  
TOOL CASES  
TOOL KITS

# INDEX

Cat.#	Page
PK-14019A	200
PK-15307EI	187
PK-15308EM	193
PK-2015	186
PK-2016	198
PK-2028T	186
PK-2061	58, 184
PK-4022EI	198
PK-4023EI	202
PK-4027AI	192
PK-4028AI	203
PK-4302AI	196
PK-6940	137
PK-6942	137
PK-9110	90
PK-ST902	35, 181
<b>PM</b>	
PM-023CN	35
PM-029CN	35
PM-036CN	35
PM-037CN	35
PM-046CN	35
PM-053CN	35
PM-055CN	35
PM-251	36
PM-252	36
PM-254	36
PM-396F	29
PM-396G	29
PM-396H	29
PM-396I	29
PM-396J	29
PM-721	34
PM-723	34
PM-727	34
PM-728	34
PM-731	32
PM-736	32
PM-737	32
PM-746	32
PM-754	32
PM-755	32
PM-923	42
PM-924	43
PM-925	42
PM-931	41
PM-934	41
PM-936	41
PM-937	41
PM-938	41
PM-955	42
PM-956	42
<b>PT</b>	
PT-0721A	128
PT-1080A	128
PT-1136A	129
PT-1201A	127
PT-1361A	129
PT-1441A	127
PT-5201A	130
PT-5501A	131
PT-5721A	130
<b>SB</b>	
SB-2419	150
SB-2918	149
SB-3218	149

Cat.#	Page
SB-3428SB	150
SB-4121	149
SB-4536B	150
<b>SD</b>	
SD-081A	87
SD-081E	89
SD-081G	87
SD-081-H1	87
SD-081-H2	87
SD-081-H3	87
SD-081-H4	87
SD-081-H5	87
SD-081-H6	87
SD-081-H7	87
SD-081-M3	87
SD-081-M3.5	87
SD-081-M4	87
SD-081-M4.5	87
SD-081-M5	87
SD-081-M5.5	87
SD-081-M6	87
SD-081-P1	87
SD-081-P2	87
SD-081-P3	87
SD-081-P4	87
SD-081-P5	87
SD-081-P6	87
SD-081-P7	87
SD-081-S1	87
SD-081-S2	87
SD-081-S3	87
SD-081-S4	87
SD-081-S5	87
SD-081-S6	87
SD-081-S7	87
SD-081-S8	87
SD-081-T1	87
SD-081-T10	87
SD-081-T10H	87
SD-081-T15	87
SD-081-T15H	87
SD-081-T2	87
SD-081-T20	87
SD-081-T20H	87
SD-081-T3	87
SD-081-T4	87
SD-081-T5	87
SD-081-T5H	87
SD-081-T6	87
SD-081-T6H	87
SD-081-T7	87
SD-081-T7H	87
SD-081-T8	87
SD-081-T8H	87
SD-081-T9	87
SD-081-T9H	87
SD-081-TA20	87
SD-081-TA23	87
SD-081-TA27	87
SD-081-TRI0	87
SD-081-TRI00	87
SD-081-TRI000	87
SD-081-TRI1	87
SD-081-Z1	87
SD-081-TS1	87
SD-081-A1	87

Cat.#	Page
SD-081-A2	87
SD-081-Z1	87
SD-081-Z2	87
SD-081-Z3	87
SD-081-Z4	87
SD-0839	88
SD-083-P2	88
SD-083-P3	88
SD-083-P4	88
SD-083-S3	88
SD-083-S4	88
SD-083-S5	88
SD-083-T4	88
SD-083-T5H	88
SD-083-T6H	88
SD-2307M	104
SD-2308M	104
SD-2310	104
SD-2313	103
SD-2318M	102
SD-2319M	102
SD-2400-S10	100
SD-2400-S4	100
SD-2400-S6	100
SD-2400-S8	100
SD-2404	100
SD-2800-I1	97
SD-2800-I11	97
SD-2800-I2	97
SD-2800-I3	97
SD-2800-I4	97
SD-2800-I5	97
SD-2800-I6	97
SD-2800-I7	97
SD-2800-I8	97
SD-2800-I9	97
SD-3102	94
SD-7213A	100
SD-7213B	100
SD-7222A	100
SD-7222B	100
SD-800-I11	98
SD-800-I8	98
SD-800-I9	98
SD-800-S3.0	98
SD-800-S5.5	98
SD-804	95
SD-804-1	95
SD-9312	89
SD-9313	90
SD-9314	90
SD-9315	91
SD-9316	91
SD-9626M	90
SD-9608	92
SD-9701M	103
SD-9802	89
SD-9804	91
SD-9810A	95
SD-9810A-BC	95
SD-9811	93
SD-9812	93
SD-9814	93
SD-9815	93
SD-9819	93
SD-9824	89

Cat.#	Page
<b>SI</b>	
SI-125A-15	81
SI-125A-20	81
<b>SK</b>	
SK-22401M	110
SK-42601M	110
<b>SR</b>	
SR-008	44
SR-228	45
SR-333	50
SR-363A	68
SR-363B	68
SR-538	46
<b>SS</b>	
SS-206E	80
SS-207E	80
SS-611A	79
SS-969E	79
SS-989A	78
<b>ST</b>	
ST-28A	179
ST-38A	179
ST-5203	179
ST-5601	179
<b>SW</b>	
SW-2125H	96
SW-9109D	101
<b>TC</b>	
TC-131	173
TC-265	148
TC-266	148
TC-267	148
TC-765	174
<b>TZ</b>	
TZ-202N	115
TZ-204N	115
TZ-205N	115
TZ-212N	115
TZ-225N	115
TZ-225N	115



**eclipse**<sup>SM</sup>

**Eclipse Enterprises, Inc.**

13302 Chula Road, Amelia Court House, VA 23002

Phone: 804-561-2610 Fax: 804-561-2642

<http://www.eclipsetools.com>

