

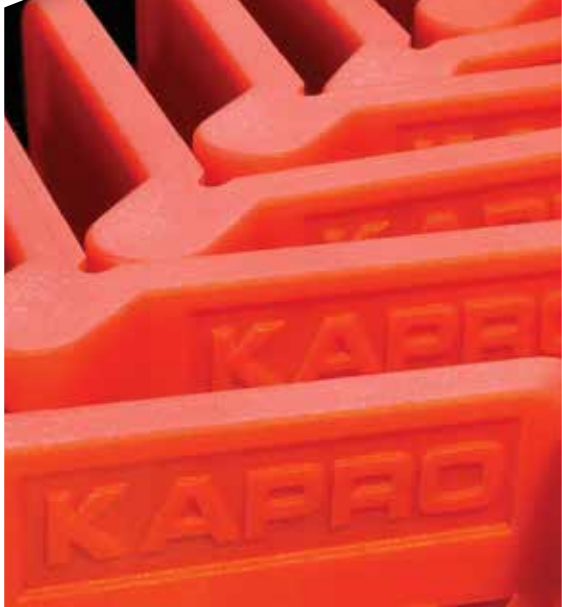

CATALOG 2014-15





KAPRO[®]
TOOLS WITH VISION

CATALOGUE

OUR CORPORATE VISION

Kapro brings the world Tools with Vision™, products that are market leaders in excellence, innovation, design, quality, and value.

Kapro is a source of growth, pride, identification, and well-being for all of its partners: customers, staff, suppliers, shareholders, and the communities in which we live.

Kapro diligently protects the environment for future generations.

Kapro represents excellence and success, throughout the world.

TO OUR SHAREHOLDERS

Kapro will always act to maximize our shareholders' long term return on capital. This aim will be achieved through fair and ethical business practices.

Kapro will operate with transparency and accountability.

TO OUR STAFF

The identification of all of our staff with Kapro and our goals is the cornerstone of the relationship between Kapro and our staff.

Kapro will act to fulfill the potential that exists in each staff member, to encourage dedication, initiative, and responsibility, and will provide our workforce with excellent work conditions, and fair remuneration for diligent work.

Kapro will maintain its family atmosphere, wherein all our employees benefit from the success of the company, with fair treatment for all.

Kapro will maintain a workplace that respects and protects the rights of all of our employees, free of harassment or discrimination.

TO OUR CUSTOMERS

Kapro will be the leading supplier of layout, marking, and measuring tools to our customers.

Kapro will give our customers an advantage over their competitors by constantly listening to their requirements, providing excellent service, maintaining outstanding quality, and creating added value in our products through innovation and design.

Our vision is that the relationships between Kapro and our customers are to be friendships which will be expressed in the complete trust and openness that we shall give to, and receive from our customers.

TO OUR SUPPLIERS

Kapro sees our suppliers as partners in the mission of meeting our customers' needs.

Kapro will always act fairly, cooperatively, and in coordination with our suppliers, with the aim of strengthening, deepening, and enhancing the mutual relationship.

TO THE COMMUNITY

Kapro will be a leading force in improving the lives of the communities within which we operate.

Kapro will protect the physical environment of our communities for the sake of future generations.

Kapro will initiate projects that reflect our commitment to our communities, as part of our concerted efforts to integrate harmoniously into each unique environment.

ABOUT US

Kapro is a leading manufacturer and developer of innovative hand tools for the professional and DIY markets. We make the industry's finest quality spirit levels, laser levels, and layout, marking and measuring tools. The company has built a reputation as the industry's foremost innovator, and is renowned for its quality products, outstanding service, added value, and cutting-edge designs.

GLOBAL DISTRIBUTION NETWORK

Kapro is a major global player in its category. Headquartered in Kadarim Israel, Kapro operates facilities in Israel, China, and the USA – all wholly owned by Kapro Industries. Our network of distribution partners has created a leading market presence in over 60 countries, throughout Europe, the Americas and Asia, and in Australasia and Africa.

INNOVATION & DESIGN

Kapro's systematic approach to innovation has given the market some of its most ground-breaking features and products. Our market-changing, patented designs include the Plumb Site® Dual-View™ vial, Optivision™ Red, Postrite® Folding Post Level, Set & Match® Ruler and Topgrade™ Gradient Level.

Kapro's Plumb Site® Dual-View™ vial is the only level feature to provide a front-on view of the plumb vial, eliminating parallax error as well as the neck and back strain that usually accompany vertical leveling jobs.

In 2010, Kapro introduced Optivision™ Red that creates a strong color definition around the spirit level's horizontal bubble, making it the clearest and most visible vial available.

To date, Kapro has registered over 100 patents throughout the world on its products and features. Kapro's unique designs are highlighted by their sleek, stand-out red look, eye-catching graphics, simplicity of design and innovative packaging. Kapro's engineering and design departments are based in Israel.

QUALITY, SERVICE & VALUE

Kapro is dedicated to excellence in every aspect of development, production, distribution, and sales and marketing. Kapro is the only level manufacturer in the world to carry the prestigious VPA mark of quality. All our manufacturing facilities are certified compliant with ISO standards 9001, 14001, and SA8000. All Kapro laser and electronic products carry FDA and CE certification, and comply with RoHS, WEEE and REACH regulations.

The Kapro brand represents high quality tools with a design edge that guarantees added value.

MERCHANDISING & SALES SUPPORT

Kapro's marketing department produces consistently high quality marketing and advertising materials for POS, trade shows and Press. Kapro has developed a range of innovative, stand-out POS displays and merchandisers that can be tailored to the needs of our customers, a set of video demos of Kapro products is available for promotional use and maintains an impressive web presence which includes up-to-date product and distributor information, as well as informative "how to" segments designed for distributors and end-users.

Success begins with vision. At Kapro, we transform great ideas into superbly crafted tools.

KAPRO. TOOLS WITH VISION™



CONTENTS



Levels8



Lasers & Intelligent Tools34



Layout & Marking48







Plumb Site® Dual-View™ Vial
 Unique front view of the vertical vial



Angle Finder
 Transfer angle measurements

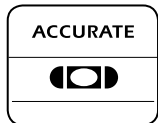

Accuracy
 Solid acrylic vials are individually calibrated

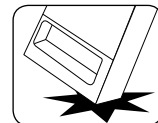

Shockproof End Caps
 Protects the level's integrity and accuracy

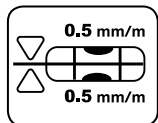

Accuracy
 Solid acrylic vials are individually calibrated



Air-cushioned Ergo Grip™ Handles
 Patented wall-grip handles with PVC air cushions

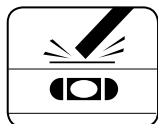

Solid Acrylic Shockproof Vials
 Superior accuracy, readability and longevity



Magnetic
 Powerful magnetic surface for accurate hands-free leveling

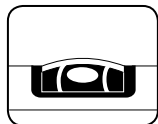

Magnified Vial
 Better readability

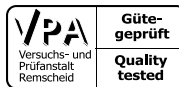

VPA
 The accuracy of Kapro levels is verified by the German VPA Laboratory

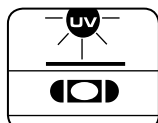

UV Resistant
 Protected from the fading effects of sunlight



Lifetime Vial Warranty
 Solid acrylic vials are guaranteed not to fog, leak or break



KAPRO CREATES

The world's most visible vials

By making vial visibility the heart of its quest for excellence, Kapro tools offer a clear advantage and are changing the way the professional contractor uses a level.

OPTIVISION™ RED A new level of visibility

OPTIVISION™ is a Kapro invention that creates the effect of strong red color definition around the spirit level's horizontal bubble, in stark contrast to the white vial background and clear liquid.

The color contrast makes the bubble edges significantly easier to see – even in low or bright light – for fast and accurate placement between the reading lines.

PLUMB SITE® DUAL VIEW™ The only true plumb view

It's the bane of every contractor, and tilers in particular: having to twist your neck to get a view of the vertical vial.

Kapro offers a unique solution that lets you view the plumb vial from the front. The patented **Plumb Site® Dual-View™** vial doesn't add much in cost to the level – but saves your neck and eyes from preventable, repetitive strain, and guarantees an accurate view of the plumb vial.

Kapro Levels - Visibly Better

990 ZEUS™ The Best Level on Earth™



- 2 Plumb Site® Dual-View™ Vial
- 1 magnified horizontal solid acrylic vial
- Keflon™ anti-stick coating
- 2 finely milled surfaces on lengths up to 48" (120cm)
- Ergonomic "Air-cushioned" handles
- Patented Ergo Grip™ non-slip feature
- Bridge at horizontal vial for increased toughness and a continuous marking surface

- "Air-cushioned" PVC shock absorbers
- Accuracy: < 0.0005 in/in. (0.5 mm/m) in all level and plumb working positions

Optional

- Rare-Earth magnets (990M)
- Available in 12 piece display

Inch	24	32	36	40	48	60	72	80	96
Centimeter	60	80	90	100	120	150	180	200	250

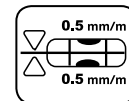
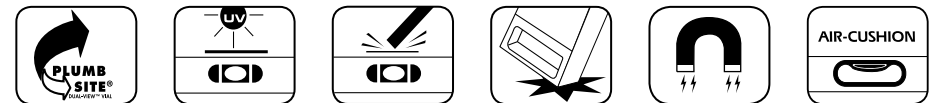

995 VULCAN™ The Next Generation



Inch	24	32	36	40	48	60	72	80	96
Centimeter	60	80	90	100	120	150	180	200	250

- Reinforced profile to maintain accuracy in tough work conditions
- 2 solid acrylic vertical vials with Plumb Site® Dual-View™ vial
- Accuracy: <math><0.0005\text{in/in}</math>. (0.5 mm/m)
- 1 magnified horizontal solid acrylic vial for a clear view of the bubble
- 2 finely milled surfaces with V-Groove for pipe measurements up to 48" (120cm)
- Rubber shockproof end caps to protect the level's integrity
- Ergonomic Bi-material handle for a comfortable grip

Optional
Magnets (995M)

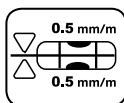
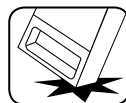
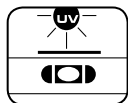

905 CONDOR™ The Professional Box Level with OPTIVISION™ Red



- 2 solid acrylic shockproof vials
- OPTIVISION™ Red horizontal vial creates highly visible red bubble edges
- Tilted horizontal vial with a direct line of sight for easy viewing
- Gradient lines for slope measurements up to 2%
- Plumb Site® Dual-View™ vial
- Bridge at horizontal vial for increased toughness and a continuous marking surface

- Oversized shock-absorbing rubber end caps with wall-grip feature
- Ergo Grip™ rubber handle
- Finely milled surface up to 48" (120cm)
- Accuracy: <math><0.0005\text{ in/in. (0.5mm/m)}</math>

Optional

- Magnets (905M)

Inch	24	32	36	40	48	60	72	80	96
Centimeter	60	80	90	100	120	150	180	200	250

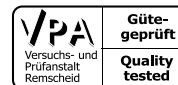
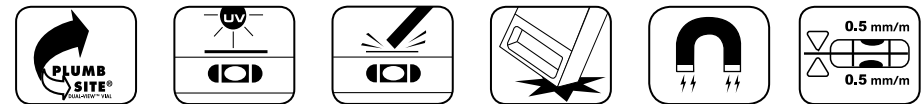

985 XL APOLLO™ Heavy-Duty Professional Box Level



Patented

870g/m

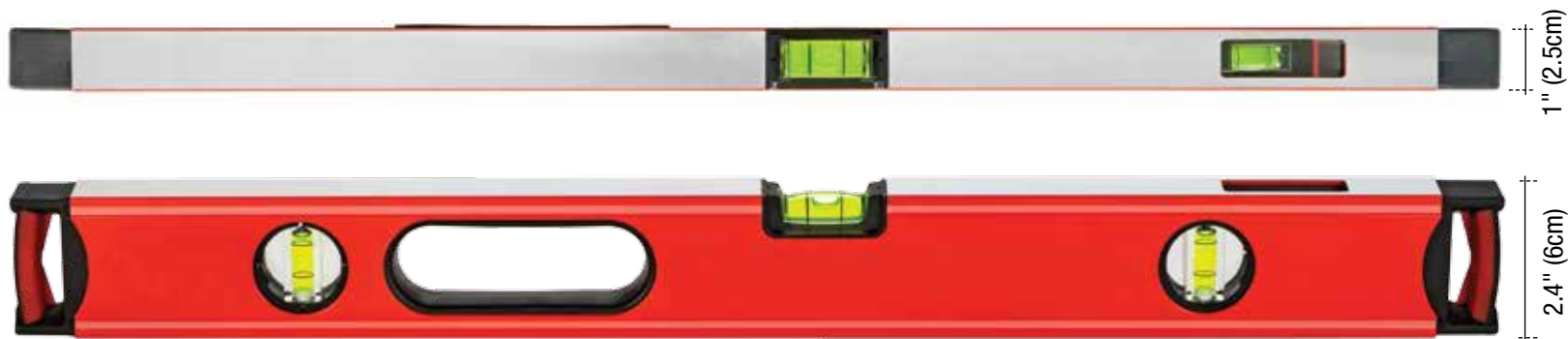

Inch	16	20	24	32	40	48	60	72	80	96
Centimeter	40	50	60	80	100	120	150	180	200	250

- Plumb Site® Dual-View™ vial
- 3 solid acrylic vials
- 1 Horizontal magnified vial
- Epoxy-locked vials
- 2 milled surfaces on lengths up to 48" (120cm)
- Shock absorbing bi-material end caps
- Ergo Grip™ non-slip handles
- Accuracy: <0.0005 in/in. (0.5mm/m)

Optional

- Magnets (985M)
- Available in 12 piece display with bag

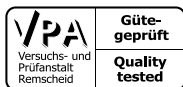
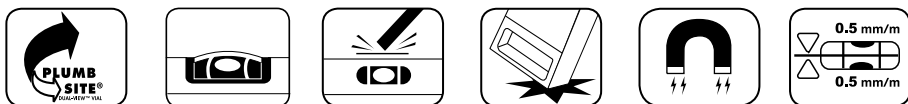

781P GENESIS™ Contractor Box Level



- Plumb Site® Dual-View™ vial
- 2 or 3 solid acrylic vials
- Epoxy-locked vials
- Milled surface on lengths up to 48" (120cm)
- Shock absorbing end caps
- Accuracy: <math><0.0005\text{ in/in. (0.5mm/m)}</math>

Optional

- Magnetic Plumb Site® model: 781PM
- Without Plumb Site®: 781, 781M
- Lightweight model: 781L
- Available in 24 piece display

Inch	12	16	20	24	32	40	48	60	72	80	96
Centimeter	30	40	50	60	80	100	120	150	180	200	250

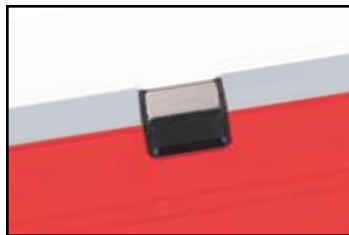

779 SPIRIT™ Heavy-Duty Professional Box Level



571g/m



Inch	8	12	16	20	24	32	40	48	60	72	80
Centimeter	20	30	40	50	60	80	100	120	150	180	200

- 2 or 3 solid acrylic vials
 - Milled surface on lengths up to 48" (120cm)
 - Shock absorbing rubber end caps
 - Wall grip feature
 - Accuracy: <0.0005 in/in. (0.5mm/m)
- Optional**
- Available in 30 piece dispenser (8"/20cm)

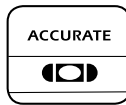
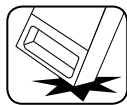
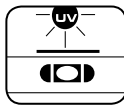

0.0005"/" (0.5mm/m)



170 SAMSON™ Contractor I-Beam Level



Patented

 842g/m

- Plumb Site® Dual-View™ vial
- 3 cylindrical vials (horizontal, vertical, optional 45°)
- 2 milled surfaces on lengths up to 48" (120cm)
- Heavy-duty aluminum frame
- Shock absorbing rubber end caps
- Ergonomic rubber handle
- Accuracy: <0.001 in./in. (1mm/m)

- Optional**
- Magnets (170M)

Inch	24	48	60	72	80
Centimeter	60	120	150	180	200



PLUMB SITE®
Accuracy

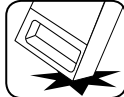





ACCURATE
0.001"/" (1mm/m)



150 I-BEAM LEVEL Quality I-Beam Level

Patented

610g/m



1" (2.5cm)

2.3" (5.8cm)

Inch	16	20	24	32	40	48	60	72	80
Centimeter	40	50	60	80	100	120	150	180	200

- Plumb Site® Dual-View™ vial
- 3 cylindrical vials
- V-groove base for leveling pipes
- Sturdy aluminum frame

- Optional**
- Angle finder
 - Magnet (159M)



130 I-BEAM LEVEL Value I-Beam Level



2.2" (5.5cm)

Inch	12	16	20	24	32	40	48
Centimeter	30	40	50	60	80	100	120

- 2 or 3 easy-to-read vials (horizontal, vertical, 45°)
- V-groove base for pipe/conduit

- Comfortable hand grip
- ABS end caps

930 SMARTCAST™ Professional Mason's Level with OPTIVISION™ Red



2.2" (5.5cm)



- 2 solid acrylic shockproof vials
- OPTIVISION™ Red horizontal vial creates highly visible red bubble edges
- Tilted horizontal vial with a direct line of sight for easy viewing
- Gradient lines for slope measurements up to 2%
- Bridge at horizontal vial for increased toughness
- Heavy-duty cast aluminum tapered body
- Shock-absorbing rubber strike pads & end caps withstand trowel blows and protect the level's integrity
- Finely milled surface
- Accuracy: <math><0.0005\text{ in./in. (0.5mm/m)}</math>

Inch	16	24	32
Centimeter	40	60	80

1.41kg/m

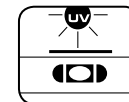

0.0005"/" (0.5mm/m)



820 SUPERCAS™



2.2" (5.5cm)



785g/m

- 3 solid acrylic vials
- Adjustable horizontal vial
- 2 milled surfaces
- Heavy-duty cast aluminum body
- Accuracy: <math><0.0005\text{ in./in. (0.5mm/m)}</math>

Inch	24	32
Centimeter	60	80

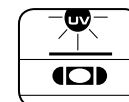

0.0005"/" (0.5mm/m)

920 SHARK® The Ultimate Mason's Level



Patented



1.8" (4.5cm)

409g/m

Inch	16	20	24	32	40
Centimeter	40	50	60	80	100

- Plumb Site® Dual-View™ vial
- 2 solid acrylic vials
- Epoxy-locked horizontal vial
- Milled surface
- Heavy-duty cast aluminum tapered (trapezoid) body

- Shock absorbing rubber "anvils"
- Accuracy: <0.0005 in/in. (0.5mm/m)

Optional

- Magnetic model: 920M

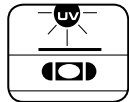

0.0005"/" (0.5mm/m)



720 SUPERCAST™



833g/m



1.8" (4.5cm)

Inch	12	16	20	24	32
Centimeter	30	40	50	60	80

- 2 solid acrylic vials
- Milled surface
- Heavy-duty cast aluminum tapered (trapezoid) body
- Accuracy: <0.0005 in/in. (0.5mm/m)

Optional

- Magnetic model: 723
- Adjustable horizontal vial on 12" (30cm) and 32" (80cm) lengths

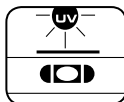

0.0005"/" (0.5mm/m)

935 OPTIVISION™ RED ToolBox Level 10" (25cm)

NEW

2.2" (5.5cm)



- OPTIVISION™ Red horizontal vial creates highly visible red bubble edges
- Tilted horizontal vial with epoxy locking for direct line of sight viewing
- Vial gradient lines for measuring slopes up to 2%
- 3 unbreakable acrylic shockproof vials
- Accuracy: <math><0.0005\text{ in./in. (0.5mm/m)}</math>
- Angle finder with gradient marking every 5°
- Rare-Earth magnets for the strongest grip to any metal surface
- Fine milled surface with V-groove
- Advanced impact resistance end caps to protect the level's integrity



Patented

270g/m

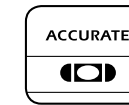
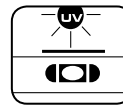

0.0005"/" (0.5mm/m)

923 CAST TOOLBOX LEVEL 10" (25cm)

1.8" (4.5cm)



- Plumb Site® Dual-View™ vial
- 3 solid acrylic vials
- Epoxy-locked horizontal vial
- Heavy-duty cast aluminum body
- V-groove for pipe/conduit
- Strong magnets
- Accuracy: <math><0.0005\text{ in./in. (0.5mm/m)}</math>
- Milled surface



Patented

233g/m

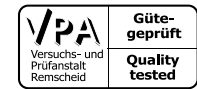
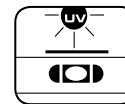

0.0005"/" (0.5mm/m)

724 KAPRO VALUE CAST TOOLBOX LEVEL 10" (25cm)



- 2 solid acrylic shockproof vials – horizontal and vertical
- Cast aluminum body
- Milled surface
- Accuracy: <math><0.0005\text{ in/in. (0.5mm/m)}</math>
- Available in 12 piece display

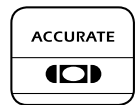

0.0005" (0.5mm/m)

929 TOOLBOX LEVEL 10" (25cm)



- Plumb Site® Dual-View™ vial
- 3 easy-to-read vials (horizontal, vertical, 45°)
- Leveling ledge for tiles/sills
- Tough internal aluminum frame and base
- V-groove magnetic strip
- Available in 15 piece display



227 TOOLBOX LEVEL 9" (23cm)



- 3 easy-to-read vials (horizontal, vertical, 45°)
- Magnetic V-groove for pipe/conduit
- Tough rubber end caps
- Available in 20 piece display

 100g/m

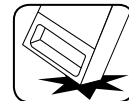

229 TOOLBOX LEVEL 9" (23cm)



- 3 easy-to-read vials (horizontal, vertical, 45°)
- V-groove for pipe/conduit
- Magnetic base
- Available in 20 piece display

 90g/m



246 HANDY LEVEL 4" (10cm)

NEW



- Shockproof solid acrylic vial
- Lightweight aluminum box profile fits easily into your tool belt or pocket
- Shockproof end caps
- Accuracy: <math><0.0005\text{ in/in}</math> (0.5mm/m)

Optional

- Magnetic
- Available in 10 piece display

80g/m

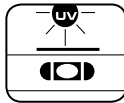

0.0005"/" (0.5mm/m)



350 PIPE LEVEL 5 PIECE SET

- For standard metal and plastic pipe sizes (see table)
- Spring loaded for easy click-on attachment
- 2 easy-to-read vials – vertical and horizontal
- Available in clip strip

Nominal Sizes	IPS Steel	CTS Copper	PP Plastic
	Stainless Steel PVC Plastic Inches/mm	Inches/mm	Inches/mm
1/2"	1/2 15	3/4 20	25
3/4"	3/4 20	1 25	32
1"	1 25	1 1/4-1 1/2 32-40	40
1 1/4" -1 1/2"	1 1/4-1 1/2 32-40	—	50
2"	2 50	—	63



340 POSTRITE® Folding Post Level

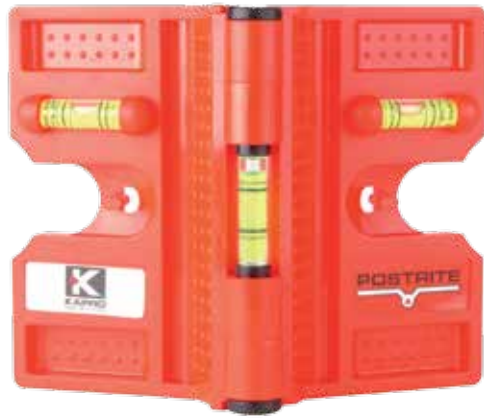

- Folds closed, opens flat
- Click-lock every 15°
- Adjustable elastic strap for non-magnetic surfaces
- 4 powerful magnets for metal surfaces
- For all posts, pipes and signs
- Available in 6 piece display

Patented

 170g/m

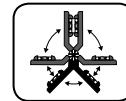
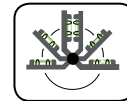

341 MINI POST LEVEL The handy post level

NEW



- 3 vials
- Adjustable elastic strap for non-magnetic surfaces
- 4 powerful magnets for magnetic surfaces
- Pre-cast holes for easy mounting with nails
- For use with all posts, pipes and signs
- Available in 12 piece display

 100g/m



985D DIGIMAN[®] Professional Magnetic Digital Level



Patented

870g/m



Inch	10	24	48
Centimeter	25	60	120



- 985M Professional Box Level with Plumb Site[®]
 - MEMS technology (Micro-Electro-Mechanical Systems)
 - LCD with backlight
 - 360° readout – flips in upside-down position
 - Magnetic in 24" (60cm) & 48" (120cm)
 - HOLD function
 - MODE function (degree/percentage/pitch)
 - MEMORY RECALL (9 measurements)
 - RECALIBRATION function and "false zero"
 - Buzzer at 0°, 45° and 90°
 - Low battery indicator
 - Digital accuracy: 0.10 at level and plumb, 0.20 at other angles
- Optional**
- Waterproof bag

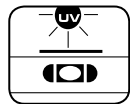

0.0005"/" (0.5mm/m)

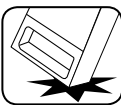

992 DIGITAL BEVEL Precise Angle Measurer and Level



- Adjustable blade locks at any angle for marking and cutting lines
- Easy recalibration
- Designed for use with power hand-saw
- Anodized aluminum profile
- Clear digital display flips for upside-down reading
- Accuracy $\pm 0.1^\circ$
- Reference angle (false zero) for transferring angle measurements

 220g/m

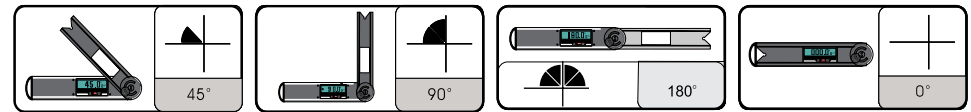

103 INCLINOMETER Gradient Level



- 1 solid acrylic vial
- Scale in % and degrees
- Accuracy: <math><0.0005\text{ in/in. (0.5mm/m)}</math>



660g/m

Optional

- Magnetic model: 103M



5.1" (13cm)

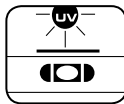

0.0005"/" (0.5mm/m)

Inch	8	12	16	20	24	32	40	48
Centimeter	20	30	40	50	60	80	100	120

104 DRAINAGE LEVEL Gradient Level up to 10%



870g/m

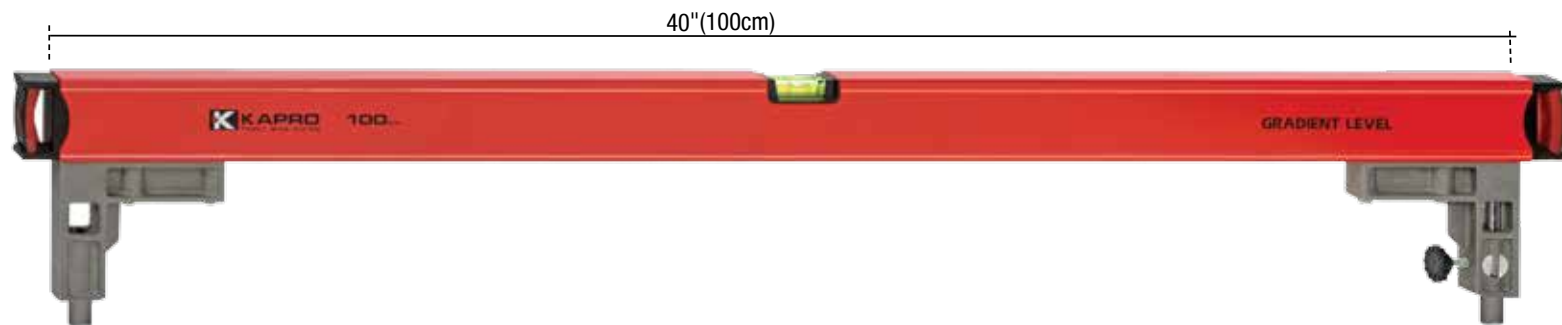

40"(100cm)

6.3"(16cm)

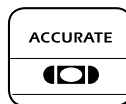

0.0005"/" (0.5mm/m)

- 1 solid acrylic vial
- Sets measuring slopes up to 10%
- Exact length (40"/100cm) for easy use
- Accuracy: <math><0.0005\text{ in/in. (0.5mm/m)}</math>

105 TOPGRADE™ Gradient Level up to 2%

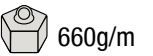

0.0005"/" (0.5mm/m)

- 4 solid acrylic vials
- Scale in % and degrees
- Accuracy: <math><0.0005\text{ in./in.}</math> (0.5mm/m)

Optional

- Magnetic model: 105M

Inch	24	40	48
Centimeter	60	100	120
	3+1 vials	5+1 vials	5+1 vials

783 ELECTRICIAN'S LEVEL Position Power Sockets Perfectly

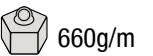

0.0005"/" (0.5mm/m)

- 4 markers set at 71 mm intervals for exact spacing of power sockets
- 2 solid acrylic shockproof vials, vertical & horizontal

- Tough aluminum box level profile
- Shock-absorbing end caps
- Vial accuracy: <math><0.0005\text{ in./in.}</math> (0.5mm/m)

Inch	17	48
Centimeter	43	120

SCREEDS

Standard ruler Lengths

Inch	40	60	70	80	96	10'	11.5'	13'
Centimeter	100	150	180	200	250	300	350	400

Tested for straightness

Model 152

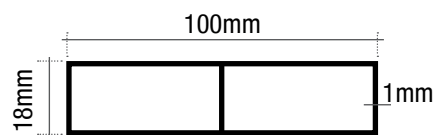

Model 154

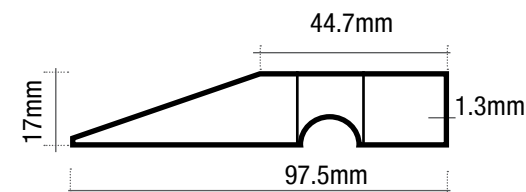

Model 153

153-31: 2 solid acrylic vials
153-32: 2 vials with handles

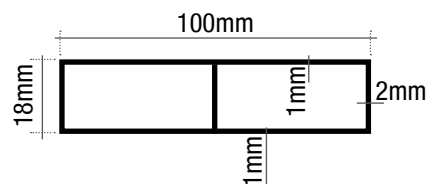

Model 155

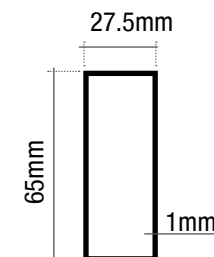

245 MINI LEVEL

- 2 easy-to-read vials
- Angle finder with patented Top-scroll Adjustment
- Pocket size
- Strong molded plastic casing



440/441 LINE LEVELS

- Especially lightweight to prevent line sag
 - V-groove for pipe work (440)
 - Handy pocket clip (440)
 - Aluminum base (441)
- Optional**
- Available as a set with 65' (20m) cord (440)



240/242 SURFACE LEVELS

- Multipurpose levels
- Pre-cast holes for easy attachment
- Sensitivity: 30arc/min.



240 Bull's Eye Level



242 Magnetic Cross Level

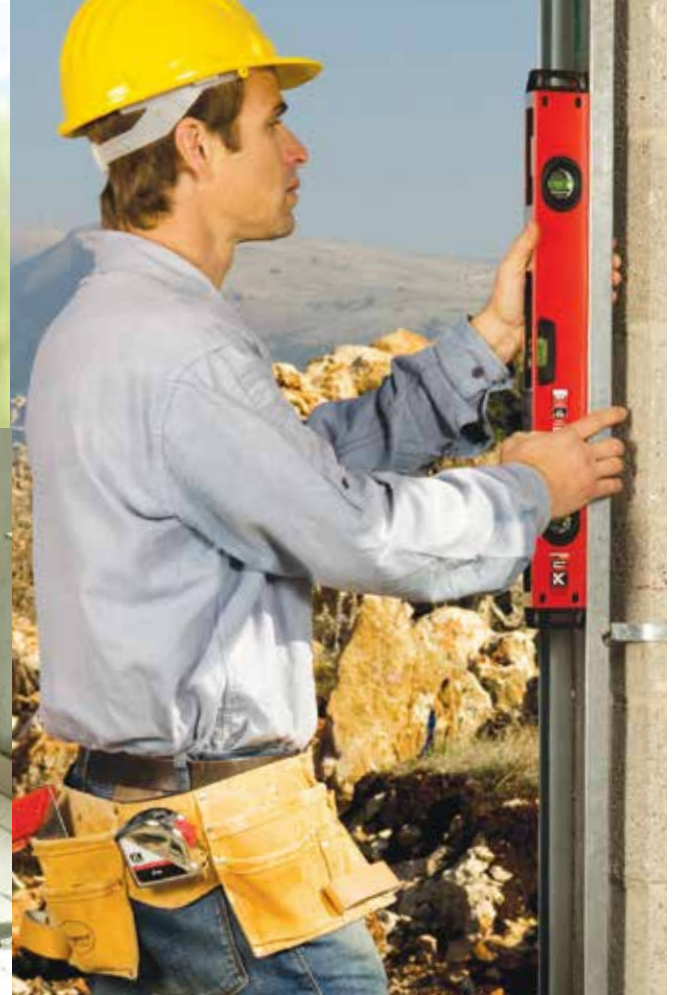



LASERS



895 PROLASER® ALL-LINES 7-Beam Self-Leveling Laser

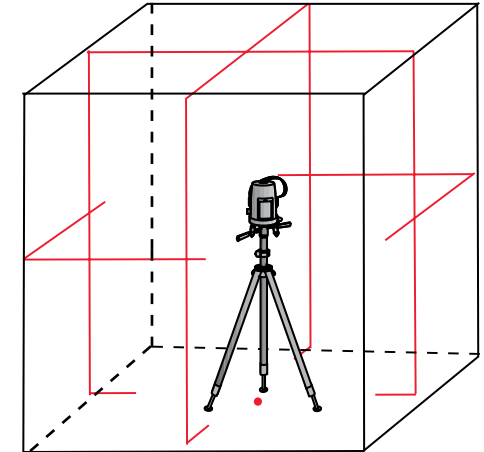

- 4 vertical & 2 horizontal cross beams, intersection at ceiling + plumb down
- Height-adjustable support legs & tripod adaptor (5/8")
- Visual & audible warning for "out of level" position
- Built-in lock-protect mechanism
- Pulse mode for outdoor use with detector
- Manual mode for leveling slopes
- Self-leveling range of $\pm 3^\circ$
- Accuracy: 0.0002in/in. (0.2mm/m)
- Indoor laser range: up to 65' (20m)
- Laser range with detector (sold separately): up to 130' (40m)

Applications

- Setting floor and wall tiles
- Hanging acoustic ceilings
- Framing and aligning windows and doors
- Leveling electrical outlets, plumbing and studs
- Drywall installation and deck construction

Includes

Beamfinder™ glasses, laser target, battery charger, carry case

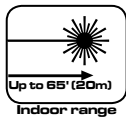

VIEW VIDEO

884 PROLASER® LAYOUT SET

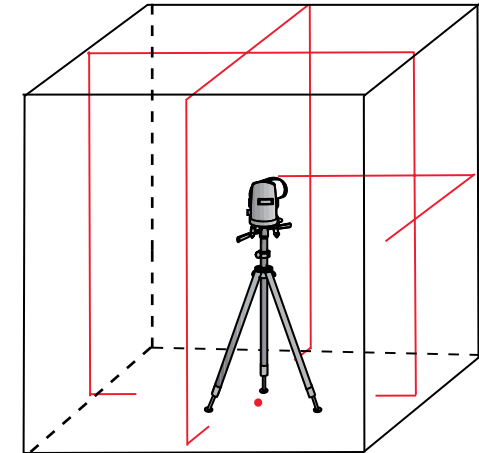

- 5 clear intersecting layout lines (4 vertical, 1 horizontal, plumb down)
- Self-leveling up to $\pm 2.5^\circ$
- 360° micro-adjustable vertical beam rotation dial
- Height-adjustable support legs for perfect horizontal beam alignment
- Tripod adaptor (5/8")
- Built-in lock-protect mechanism
- Visual warning for out of level position
- Pulse mode for outdoor use with detector (sold separately)
- Accuracy: 0.0002in/in. (0.2mm/m)
- Indoor range <10m (33') -
Outdoor range with laser detector (sold separately) <30m (100')

Applications

- Setting floor and wall tiles
- Hanging acoustic ceilings
- Framing and aligning windows and doors
- Leveling electrical outlets, plumbing and studs
- Drywall installation and deck construction

Includes

Beamfinder™ glasses, laser target, hard carry case

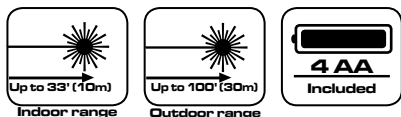

888 PROLASER® VECTOR 3 Beam Self-Leveling Laser

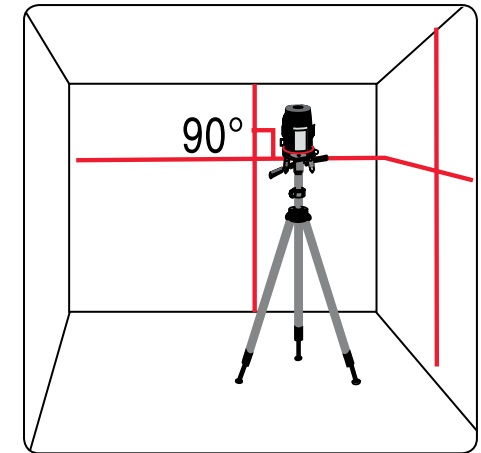

- 2 vertical and one horizontal beam
- Self-leveling range of $\pm 3^\circ$
- Audible warning for "out of level" position
- Integrated locking mechanism
- Rugged impact absorbing "work-site armor"
- Tripod-ready
- Accuracy: 0.0003in/in. (0.3mm/m)
- Laser Range: up to 100' (30m)
- Can be used with power adaptor

Applications

- Aligning windows and doors
- Hanging acoustic ceilings

Includes

Carry case and wall mount, Beamfinder™ glasses

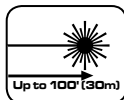

VIEW VIDEO

894 PROLASER® VISI-CROSS™ Indoor/Outdoor Self-Leveling Cross Laser

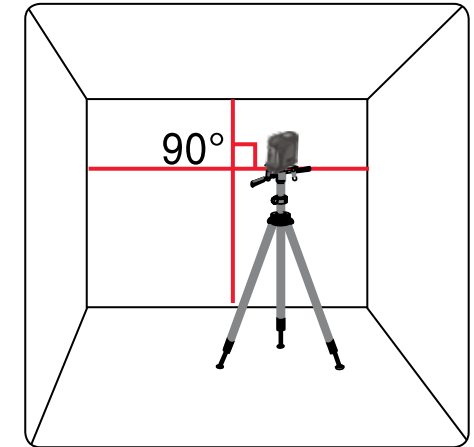

- Intersecting horizontal and vertical line
- Self-leveling range of $\pm 4^\circ$
- Pulse mode for outdoor use with detector (included)
- Visual & audible warning for "out of level" position
- Shockproof rubber casing
- Accuracy: 0.0003in/in. (0.3mm/m)
- Laser range: up to 130' (40m) with detector
- Tripod ready (5/8" to 1/4")

Applications

- Aligning tiles, borders, moldings, trims
- Hanging shelves, pictures, cabinets
- Constructing decks

Includes

Laser target, multi functional magnetic bracket, detector, carry case

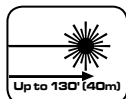

VIEW VIDEO

892 PROLASER® PLUS Self-Leveling Cross-Beam Laser

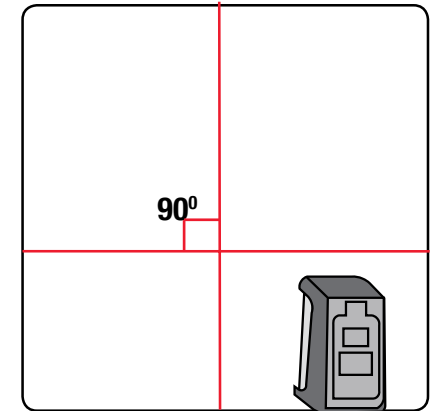

- 2 laser lines (vertical and horizontal)
- Self-leveling in 5 seconds
- Internal lock-protect mechanism
- Shock absorbing rubber casing
- Tripod-ready
- Leveling range: $\pm 5^\circ$
- Accuracy: 0.0003 in/in. (0.3 mm/m)
- Laser Range: up to 65' (20m)

Applications

- Hanging shelves, pictures and cabinets
- Aligning tiles, borders, moldings, and trims
- Building decks

Includes

Belt pouch

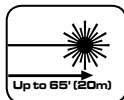

841 TRIPOD ADAPTOR

- Converts tripod thread from 5/8" UNC to 1/4" UNC
- Compatible with Prolaser® Plus 892



VIEW VIDEO

891 PROLASER® LASER SQUARE

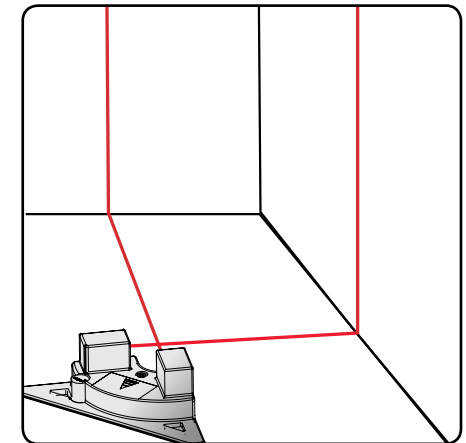

- Projects 90° highly visible laser lines on the floor and corresponding wall
- ABS unit with aluminum base for improved flatness
- Quick & easy one-button operation
- Highly accurate laser: 0.0005 in/in (0.5mm/m)
- Cylindrical vial & surface level: accurate to 0.001 in/in (1mm/m)
- Laser Range: up to 100' (30m) with target

Applications

- Flooring, tile layout, paneling, wallpapering, stenciling, wainscoting
- Finish carpentry
- Outlet and switch layout
- Wall stud layout and partition installation

Includes

Laser target, batteries, soft carry case

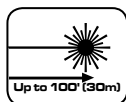

VIEW VIDEO

896 PROLASER® 5-DOT Self-Leveling Laser Pointer

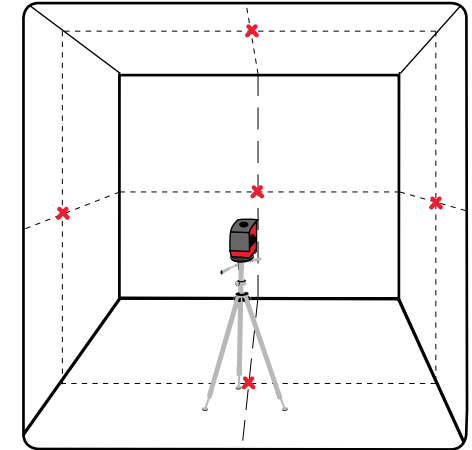

- Five highly visible laser dots: Plumb up & down, 3 level dots at 90° angles
- Small cross projected at each laser dot
- Tough rubber overlay
- Quick & easy one-button operation
- Self leveling range $\pm 4^\circ$
- Tripod-ready
- Laser accuracy – Level: 0.4mm/m, Plumb up: 0.5mm/m, Plumb down: 0.75mm/m
- Laser range: up to 100' (30m) with target
- Visual out of leveling range flashing beams

Applications

- Wall stud layout and partition installation
- Electrical outlet and switch layout
- Framing rooms, doors and windows
- Finishing carpentry
- Transferring points
- Vertical and horizontal alignments

Includes

Magnetic multi-functional base, laser target, soft carry case

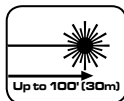

VIEW VIDEO

899 PROLASER® SELF-LEVELING ROTA-LINE



- Horizontal or vertical 360° rotating beam in horizontal or vertical planes, plumb up and plumb down points
- Electronic self-leveling on slopes of $\pm 5^\circ$
- Manual leveling for marking slopes of up to $\pm 5^\circ$ in both X and Y planes
- Five variable speeds (0, 60, 120, 300, 600 rpm)
- Six scan modes create visible laser line
- Tripod-ready
- Accuracy: 0.0001 in/in. (0.1 mm/m)
- Laser Range: Indoor - up to 164' (50m),
Outdoor - up to 820' (250m) with detector

Applications

- Laying foundations
- Wall, fence and deck construction
- Laying water and sewerage lines
- Indoor layouts

Includes

Remote control, laser detector, shockproof carry case, BeamFinder™ glasses
Supplied with internal batteries and battery charger - AC/DC convertor



VIEW VIDEO

370 KAPROMETER K4 Laser Distance Measurer



- Measures distance, area and volume
- Simple and easy to use keypad
- Backlit LCD display
- Automatic measurement timer
- Dynamic (continuous) measuring for finding the shortest distance to target
- Indirect measuring using Pythagorean theorem
- Choice of 3 reference points
- Advanced memory function
- Impact-resistant rubber
- Tripod-ready 1/4" thread
- Accuracy: 1.5mm/70m
- Indoor range < 230' (70m)
- Outdoor range < 32' (10m)



389 MULTISCANNER STUD SENSOR Electronic Cable, Metal & Stud Sensor



- Electronic sensors detect live AC wires, metal, studs & wood
- Detection buzzer
- Easy to read backlit screen
- Automatic scan



VIEW VIDEO

893 T-LASER™ Clip-on Marking Laser

Patented

- 90° highly visible laser beam
- Spring grip slides onto edge of standard boards 1/4"-5/8" (6.4mm-15.9mm)
- Pressure-activated power switch
- Manual on/off switch for use as surface laser
- Bi-material molded case with rubber overlay

- Handy belt clip
- Laser Range: up to 10' (3m)

Applications

- Marks 90° laser line for free-form cutting
- For drywall, composition board, and plywood

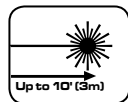

810 PROLASER® NAIL GRIPPER™ Line Laser with Nail and Screw Grip

Patented

- Highly visible line laser
- 2 easy-to-read vials
- Patented rubber grip holds any size nail/screw
- Pressure-activated on/off
- Magnetic wristband included for holding nails and screws
- Laser range: up to 20' (6m)

Applications

- Hanging shelves, pictures, and mirrors
- Aligning panels, tiles, and wall coverings

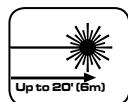

814 PROLASER® SET-A-SHELF™ Set & Match® with Laser Line

Patented

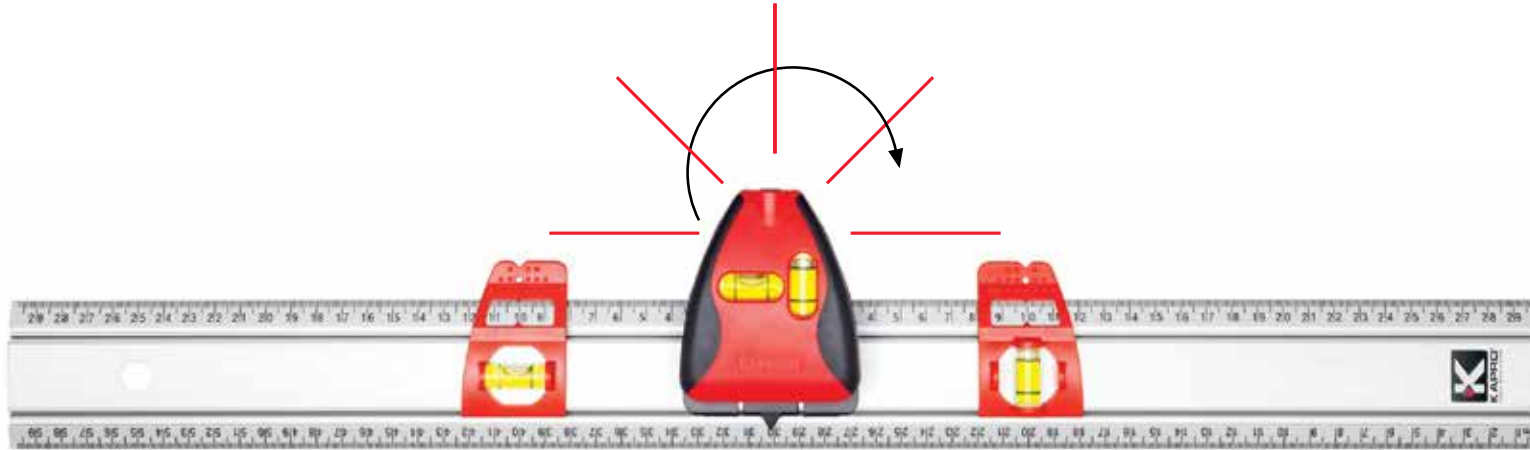

- Horizontal, vertical or 45° lines
- 2 easy-to-read vials
- "Click-in-place" lock
- "Slide & Lock" level markers
- Laser Range: up to 20' (6m)

Applications

- Hanging shelves, pictures and cabinets
- Aligning tiles, decorative layouts and patterns

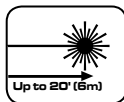

886-48/38 Tripod for Laser Level

- Professional tripod – up to 2.32 meters, with scale and vial (886-48)
- Lightweight tripod – up to 1.20 meters, with vial (886-38)



886-10 Leveling Disk for Laser Level

- Attachment fits standard tripod
- Locking screw to secure laser level at required angle
- Rotary scale in degrees
- Standard 5/8" UNC (16mm) thread for attachment to tripod



886-20 Laser angle mount

Accurate indication of inclined angle



886-30 Extendable Mounting Pole for Laser Level

- Self-clamping between floor and ceiling
- 3.20 meters maximum height
- Includes adjustable laser mount with 5/8" UNC thread



886-58 Pole with Tripod

3.20 meters maximum height



845 Laser Target

- Magnetic
- Special reflective surface
- Graduated target (in/cm)



840 Beamfinder™ Glasses

Enhances visibility of laser beam





**LAYOUT,
MARKING & MEASURING**

Cutting-Edge Designs



215 STAINLESS STEEL CHALK LINE WITH LINE LEVEL

Detachable line level & extra-fast rewind



- Break-resistant & powder absorbent chalk line string
- Plumb-bob design with tough stainless steel casing & rubber molding
- Detachable line level clicks into chalk line
- **6X faster** rewind with string lock mechanism
- All-in-one end hook: holds on nails & ledges, tacks into drywall
- Clean chalk refill – won't spill
- 4 oz (113g) capacity & 100' (30m) line

Patented



214 SURE GRIP CHALK LINE & LEVEL

Integrated line level & extra-fast rewind



- "Sure Grip" ergonomic handle & shockproof bi-material case
- Retractable line level clicks into chalk line
- **6X faster** rewind with string lock mechanism
- All-in-one end hook: holds on nails & ledges, tacks into drywall
- Break-resistant & powder absorbent chalk line string
- Clean chalk refill – won't spill
- Wall mount & storage hanger
- 4 oz (113g) capacity & 100'(30m) line

Patented



213 ERGONOMIC CHALK LINE Rubber "nose" holds line taut

Patented



- Break-resistant & powder absorbent chalk line string
- Ergonomic handle
- Rubber nose – holds line for perfect string tension
- All-in-one end hook: holds on nails & ledges, tacks into drywall
- Clean chalk refill – won't spill
- Wall mount & storage hanger
- 3 oz (85g) capacity & 100' (30m) line

Optional

Available as a set with 4 oz (113g) red or blue chalk bottle



211 PLUMB BOB CHALK LINE Classic design

- Durable Easy Grip™ case
- All-in-one end hook: holds on nails & ledges, tacks into drywall
- Break-resistant & powder absorbent chalk line string
- Clean chalk refill – won't spill
- Wall mount & storage hanger
- 3 oz (85g) capacity & 100' (30m) line

Optional

Available as a set with 4 oz (113g) red or blue chalk bottle



201 ZINC CHALK LINE Plumb bob design



- Heavy-duty zinc body
- Doubles as a plumb bob
- 3 oz (85g) capacity
- 100' (30m) highly absorbent polyester line



222 CHALK BOTTLES Available with blue and red chalk



- 4 oz (113g)
 - 8 oz (226g)
 - 2.5 lb (1kg)
 - 5 lb (2kg)
-

325 MAGNETIC LOCK COMBINATION SQUARE

Patented



- Magnetic lock adjustment
- Stainless steel blade
- Permanently etched ruler markings (inches and centimeters)
- Heavy-duty cast zinc body
- 5 milled sides for superior accuracy
- Easy Grip™ magnet-held stainless steel scriber
- Belt holster included
- Ruler available in 6" (15cm), 12" (30cm) and 16" (40cm) lengths
- Easy to read vial



352 COMBINATION SQUARE

- Heavy-duty cast zinc body
- Milled on all sides
- Stainless steel blade
- Permanently etched ruler markings (inches and centimeters)
- Ruler available in 12" (30cm) and 16" (40cm) lengths
- Easy to read vial



309 LEDGEND™ SQUARE

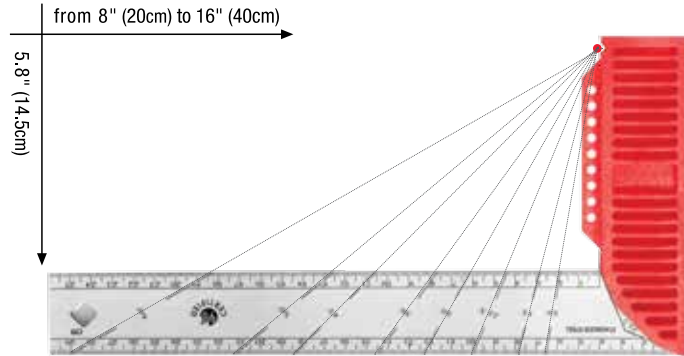

- Unique support ledge
- High-impact polymer handle
- Permanently etched stainless steel blade
- 22.5°, 45°, 67.5° and 90° angles for beveling and framing
- Inch/cm gradations
- Certified 90°
- Marking point

Patented

Inch	8	10	12	16
Centimeter	20	25	30	40



307 TRY & MITRE SQUARE

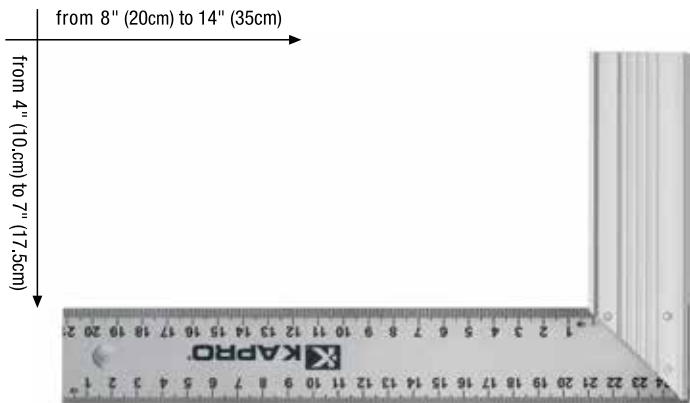

- Solid riveted construction
- Stainless steel non-corrosive tempered blade
- Permanently etched long life gradations
- Certified 90°

Inch	8	10	12	14
Centimeter	20	25	30	35

444 RAFTER SQUARE 7"

- Durable & lightweight Ergocast™ material
- Molded-in conversion tables
- Easy-to-read gradations
- Base enables easy marking and cutting



305 FRAMING SQUARE

- Heavy duty painted steel frame
- Durable high visibility printing for all work conditions
- Complete conversion and rafter tables printed on reverse side

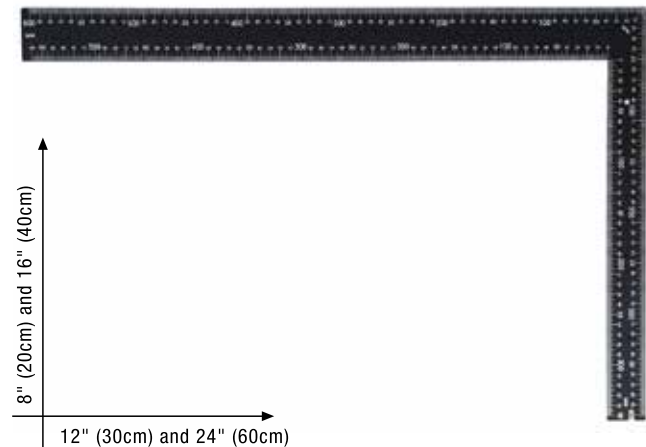

302 STAIR GAUGE

- Solid brass construction
- For use with framing square
- For stair layout and any other repeat marking



301 T-BEVEL



- Easy-to-read vial
- Built-in 3/16" (5mm) trim gauge on side and bottom
- Angle markings on handle
- Etched stainless steel blade and bolt
- Inch/cm gradations



303 CERAMIC HOLE MARKER

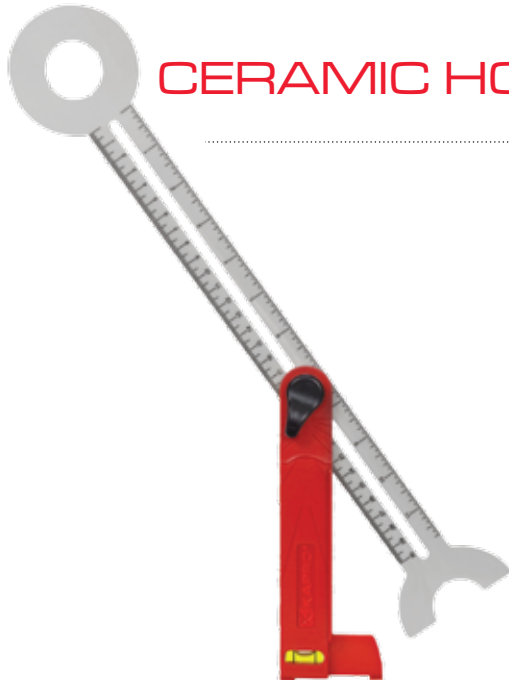

- Fits all standard tile dimensions
- Two hole sizes (75mm, 32mm) for electrical outlets and pipes
- Half-hole for taking measurements after faucet installation
- Fiberglass-reinforced polymer handle with easy-to-read vial
- Angle markings on handle – every 15° & strong screw lock
- Durable PVC sliding ruler (inch/cm gradations)
- 90° wing for perfect accuracy, designed for work with spacers



318 ELECTRICAL OUTLET MARKER



- Two easily adjustable, interlocking squares
- Two vials for easy level and plumb alignment
- Vial Accuracy: ± 1 mm/m
- ABS
- Measuring and marking for electrical socket installation



630 TELESCOPIC ALUMINUM RULER

- Height reading at eye level
- Easy to store
- Solid construction maintains accuracy



Feet	10	12
Meter	3	4

316 DRYWALL T-SQUARE

- Anodized aluminum finish
- Double edge and angular marking
- Certified 90°
- For marking and cutting all types of drywall/wood
- Angler markings 15°, 20°, 22.5°, 30°, 45°, 60°, 70°, 75°, 80°
- Available in 36" (90cm), 48" (120cm) lengths

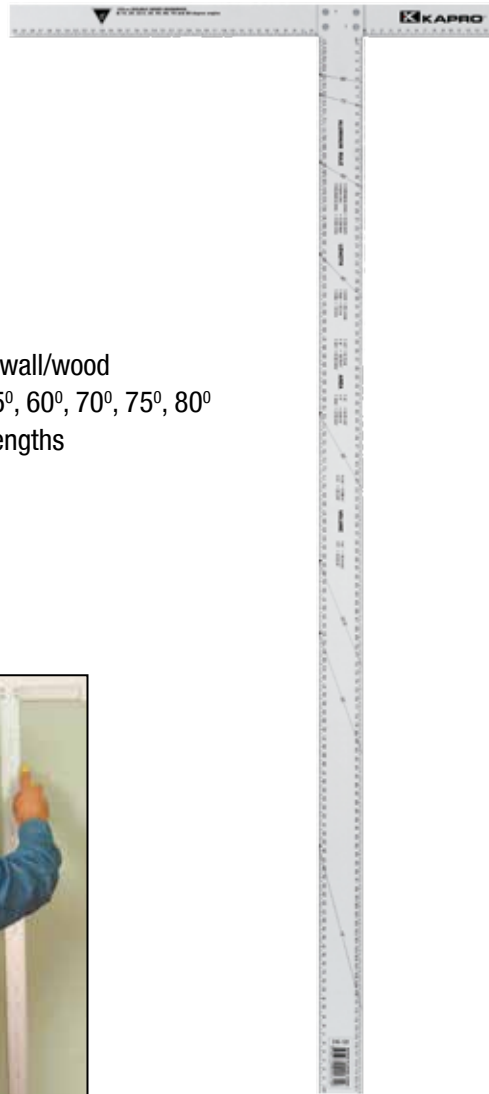
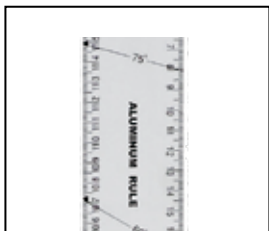
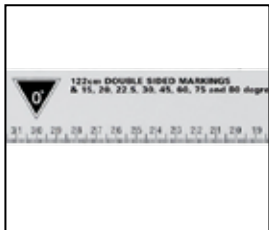

317 ADJUSTABLE T-SQUARE

- Anodized aluminum finish
- Sliding head adjusts to any angle
- Folds for easy storage
- ABS end caps with ledge: hands free hold, won't flip
- Double edge, heavy-duty blade
- Durable printed scale and etched angle markings
- Strong screw lock
- 48" (120cm) length

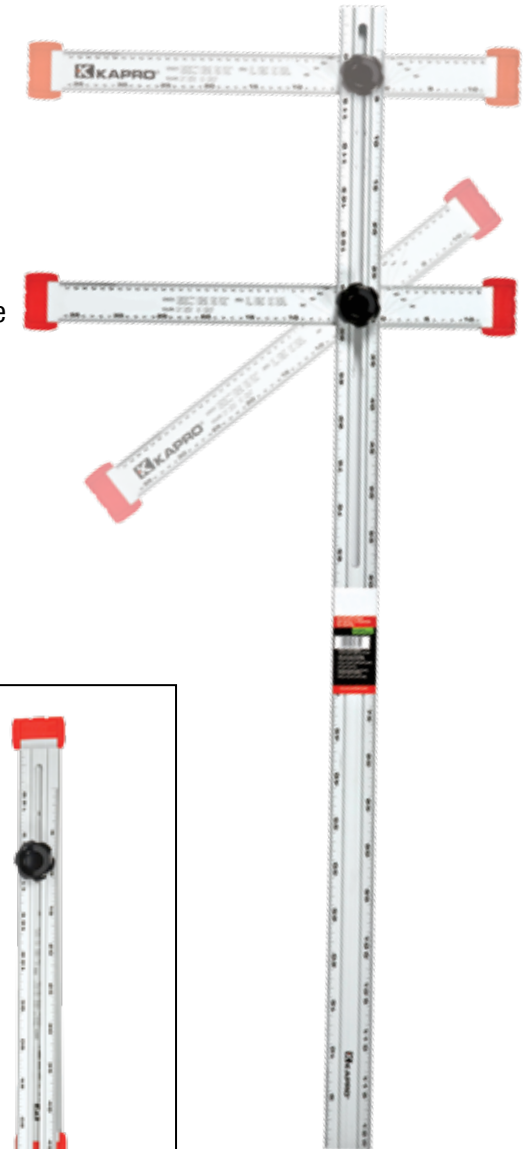
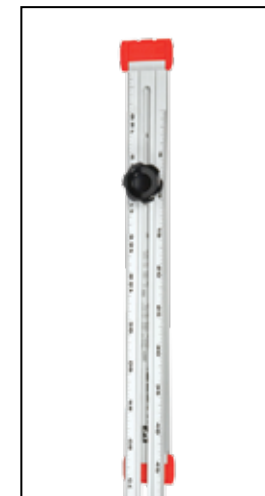
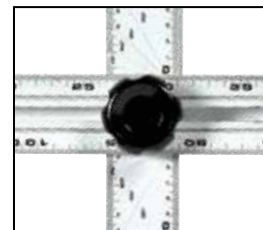

314 SET & MATCH® SYSTEM The ultimate layout and marking tool

Patented

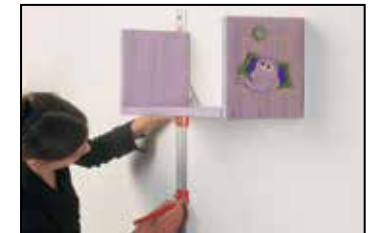

Custom-build your own layout and marking tool – in seconds – with the Set & Match® System. Just “slide and lock” your choice of accessories to the patented Set & Match® Ruler, for the perfect drywall, carpentry or multi-purpose laser tool.

- Patented Set & Match® Ruler
- 2 easy-to-read slide & lock vials -horizontal and vertical
- Non-slip foam backing

Applications

- Setting and aligning shelves, cabinets, mirrors, stencils & wallpaper
- Marking/cutting longer lines on walls, wood, drywall, cardboard
- Marking/cutting angled lines



Handle & Sliding Knife Guide

Auto-lock for a sure grip & spring-loaded sliding knife guides: slide along the ruler - lock in place. Doubles as a pencil guide. Prevents accidents.



T-Square

Turn your Set & Match® Ruler into a T-Square – with built-in storage and magnetic bar for holding nails & screws.



Laser line with stud finder

Click-locks at 90° and 45°. Finds concealed metal studs in drywall (See Prolaser® Set-a-Shelf™ p.46)

Inch	20	24	30	32	40	48
Centimeter	50	60	70	80	100	120

313 MEASURE MATE The Ultimate Home-Improvement Tool



Level
Sturdy triangular profile + 2 easy-to-read vials



Align
Sliding markers: set & transfer measurements



Place
Electrical & plumbingscale for power sockets & faucets



Cut
Sliding knife guide: safe & accurate



Center
Zero & center point scales



Grip
Nail gripper and drill bit diameter gauge: safe and easy nailing

Inch	12	24	32	40	48
Centimeter	30	60	80	100	120



Available in 15 piece Cardboard display

RULERS

Standard ruler Lengths

Inch	2	16	20	24	32	40	48
Centimeter	30	150	180	200	250	300	350

306 RULER

- Anodized aluminum ruler
- Durable printing
- Wear-resistant UV cured screen printing
- Printed scale accurate to 0.7mm/m
- 1.2" (3cm) width

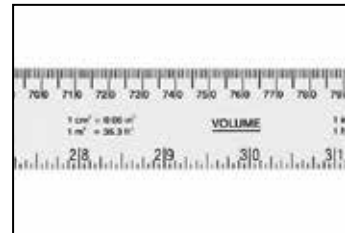

308 STRAIGHT EDGE

- Contractor grade
- Anodized aluminum
- Wear-resistant UV cured screen printing
- Printed scale accurate to 0.7mm/m
- 2" (5cm) width

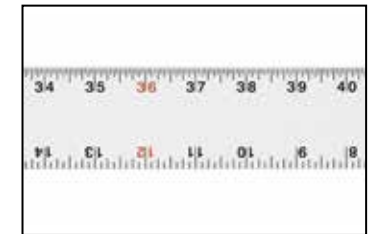

310 STRAIGHT EDGE

- Contoured profile for easy handling
- Single edge markings
- Wear-resistant UV cured screen printing
- Printed scale accurate to 0.7mm/m
- 2.4" (6cm) width

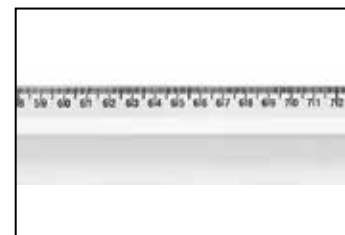

312 CUTTING EDGE

- Cutting Edge with handle
- Wear-resistant UV cured screen printing
- Printed scale accurate to 0.7mm/m
- 2.4" (6cm) width

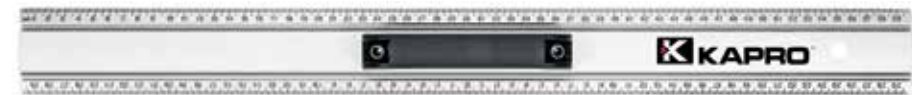
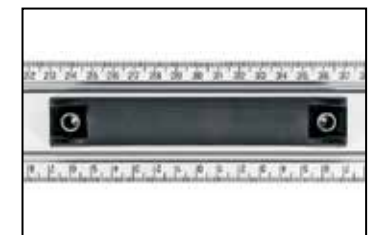

608 FRAMING TAPE MEASURE



Patented

- Easily centers on corners for accurate diagonal measurements
- Excellent blade extension
- Convenient belt clip
- Pro Touch™ heavy-duty rubber casing

5m	8m
----	----

500 STEEL POWER TAPE



- Spring loaded blade return
- One-touch lock mechanism
- Available in inch or centimeter gradations

3m	5m	8m
----	----	----

261 CARPENTER'S SHARPENER & PENCILS SET

- For all carpenter's pencils
- Available carded with pencil set
- Top quality
- Pencils won't crumble during sharpening



275 CARPENTER'S SHARPENER

- For all carpenter's pencils
- Available carded with pencil set
- Top quality
- Pencils won't crumble during sharpening



206 FOLDING RULER

- Unbreakable solid beech wood sections
- Multilayer surface treatment
- Milled ends on scale sections
- Lubricated steel locks & brass fittings
- Centimeter gradations
- Lengths: 1m, 2m



660 OPEN REEL TAPES

- Open style for easy wash down
- Heavy duty ABS case
- Marking spike
- Stainless steel end-claw for distance anchoring
- Zero at end of hook
- Lengths: 30m, 50m



601 MEASURING WHEELS

- Lightweight and durable telescopic handle
- Metric or imperial reading available
- Wheel diameters: 4" (10cm), 12" (30cm)





MERCHANDISING & PROMOTIONS

Stand out from the Crowd



COUNTER DISPLAYS Eye-catching, call-out visuals



810 Prolaser® Nail Gripper™

6 piece cardboard display

Dimensions:

11.4" (w) x 9.45" (d) x 11" (h)

29cm (w) x 24cm (d) x 28cm (h)

246 HANDY LEVEL 10cm

10 piece cardboard display

Dimensions:

5.5" (w) x 4.7" (d) x 8.2" (h)

14cm (w) x 12cm (d) x 21cm (h)



340 Postrite®

6 piece cardboard display

Dimensions:

7.7" (w) x 7.7" (d) x 9.45" (h)

19.5cm (w) x 19.5cm (d) x 24cm (h)



318 ELECTRICAL OUTLET MARKER™

6 piece cardboard display

Dimensions:

15.7" (w) x 7.4" (d) x 12.2" (h)

40cm (w) x 19cm (d) x 31cm (h)



341 Postrite®

12 piece cardboard display

Dimensions:

8.6" (w) x 7.9" (d) x 3.4" (h)

22cm (w) x 20cm (d) x 9cm (h)



COUNTER DISPLAYS Eye-catching, call-out visuals

227 Toolbox Level 9" (23cm) 20 piece cardboard display

Dimensions:
11.4" (w) x 9.45" (d) x 11" (h)
29cm (w) x 24cm (d) x 28cm (h)



229 Toolbox Level 9" (23cm) 20 piece cardboard display

Dimensions:
11.4" (w) x 9.45" (d) x 11" (h)
29cm (w) x 24cm (d) x 28cm (h)



724 Cast Toolbox Level 10" (25cm) 12 piece display

Dimensions:
12" (w) x 9.45" (d) x 2" (h)
30cm (w) x 24cm (d) x 5cm (h)

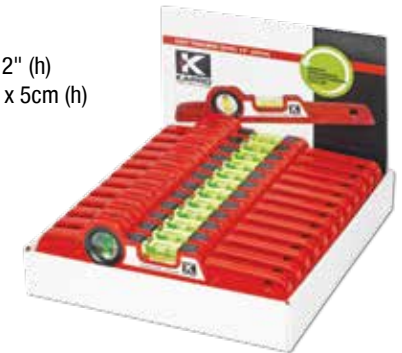

313 Measure Mate 12" (30cm) 15 piece cardboard display

Dimensions:
11.8" (w) x 11.8" (d) x 15.7" (h)
30cm (w) x 30cm (d) x 40cm (h)



929 Toolbox Level 10" (25cm) 15 piece cardboard display

Dimensions:
11.4" (w) x 9.45" (d) x 11" (h)
29cm (w) x 24cm (d) x 28cm (h)



FLOOR DISPLAYS Showcase Kapro advantages

313 Measure Mate up to 48" (120cm)
15 piece cardboard display



24 piece metal display
For Box and I-Beam levels 16"-48"
(40cm-120cm).
Ships flat, ready to assemble



12 piece metal display
Ideally suited to the Zeus™ 990,
this display has three steps,
and holds four levels at each height,
for maximum effect.
Ships flat, ready to assemble



314-90 T-Square Work
Center (120cm)
10 piece cardboard display



12 piece metal display
Designed for 985 Apollo™
Levels with bag (48"/120cm)
Ships flat, ready to assemble





www.kapro.com
E-mail: quality@kapro.com